

The way
to do it
better

LED line



LED line



Nowoczesność na pierwszym miejscu

W LED line nieustannie dążymy do ulepszania naszych produktów, aby sprostać rosnącym wymaganiom rynku. Wprowadzane przez nas nowe rozwiązania są efektem intensywnych prac badawczo-rozwojowych, skoncentrowanych na innowacyjności i optymalizacji. Dzięki temu nasze produkty są nie tylko bardziej wydajne, ale też cechują się wyjątkową trwałością i wszechstronnością zastosowań. Nasze nowości odpowiadają na aktualne potrzeby klientów, oferując im najwyższą jakość, niezawodność i nowoczesny design, który doskonale wpisuje się w różnorodne projekty oświetleniowe.





Ministerstwo
Sportu i Turystyki
tworzymy
polski sport

Ministerstwo
Sportu i Turystyki
tworzymy
polski sport

Ministerstwo
Sportu i Turystyki
tworzymy
polski sport















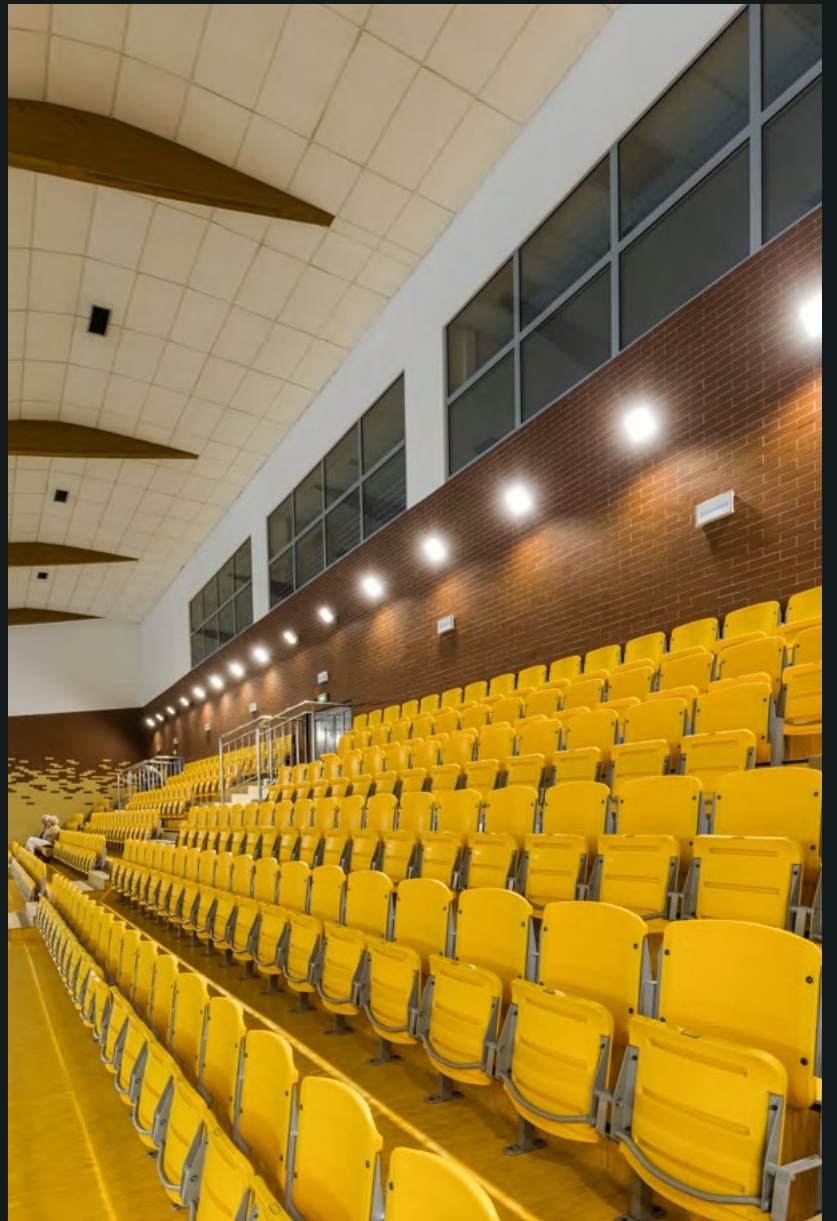



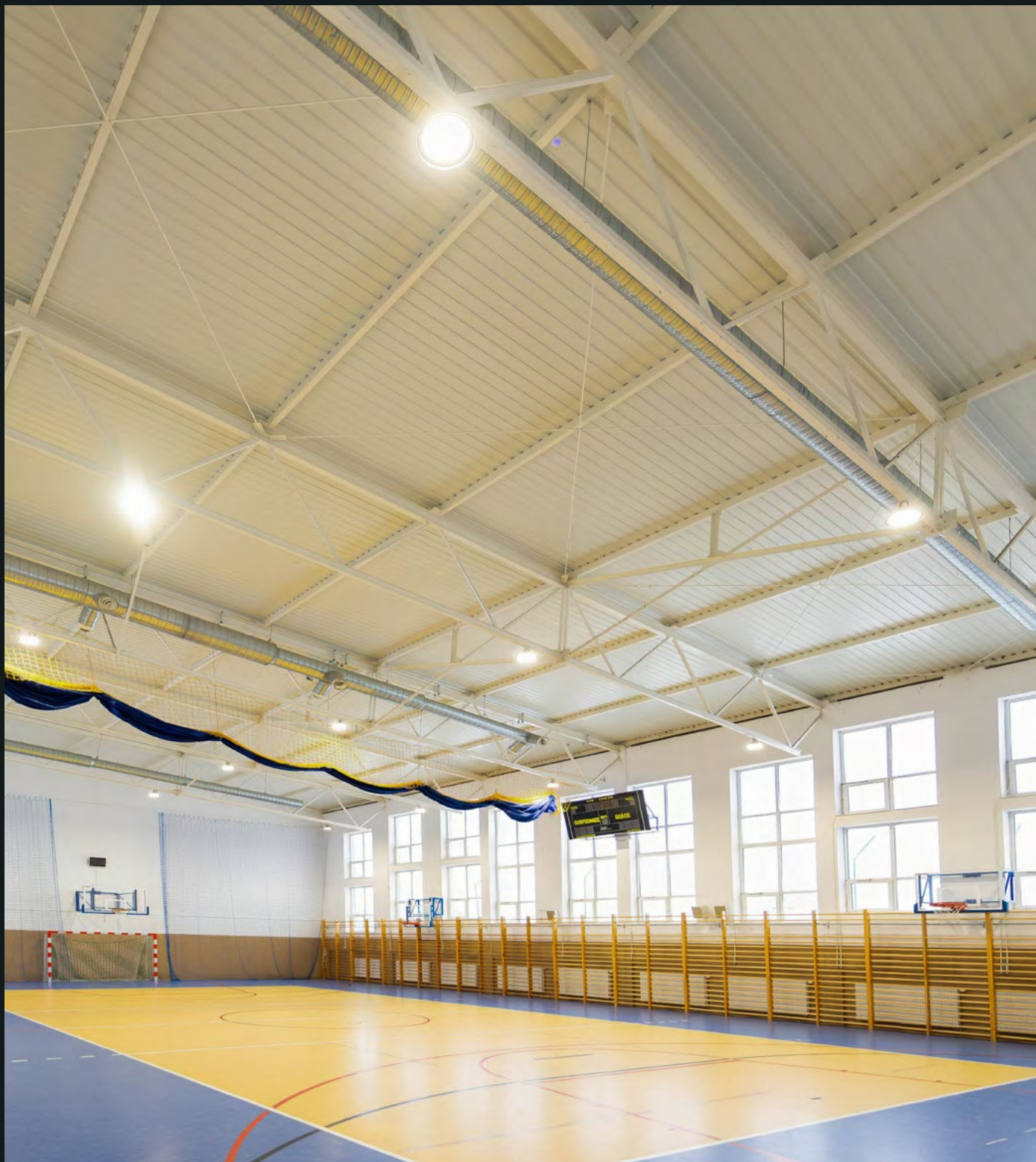



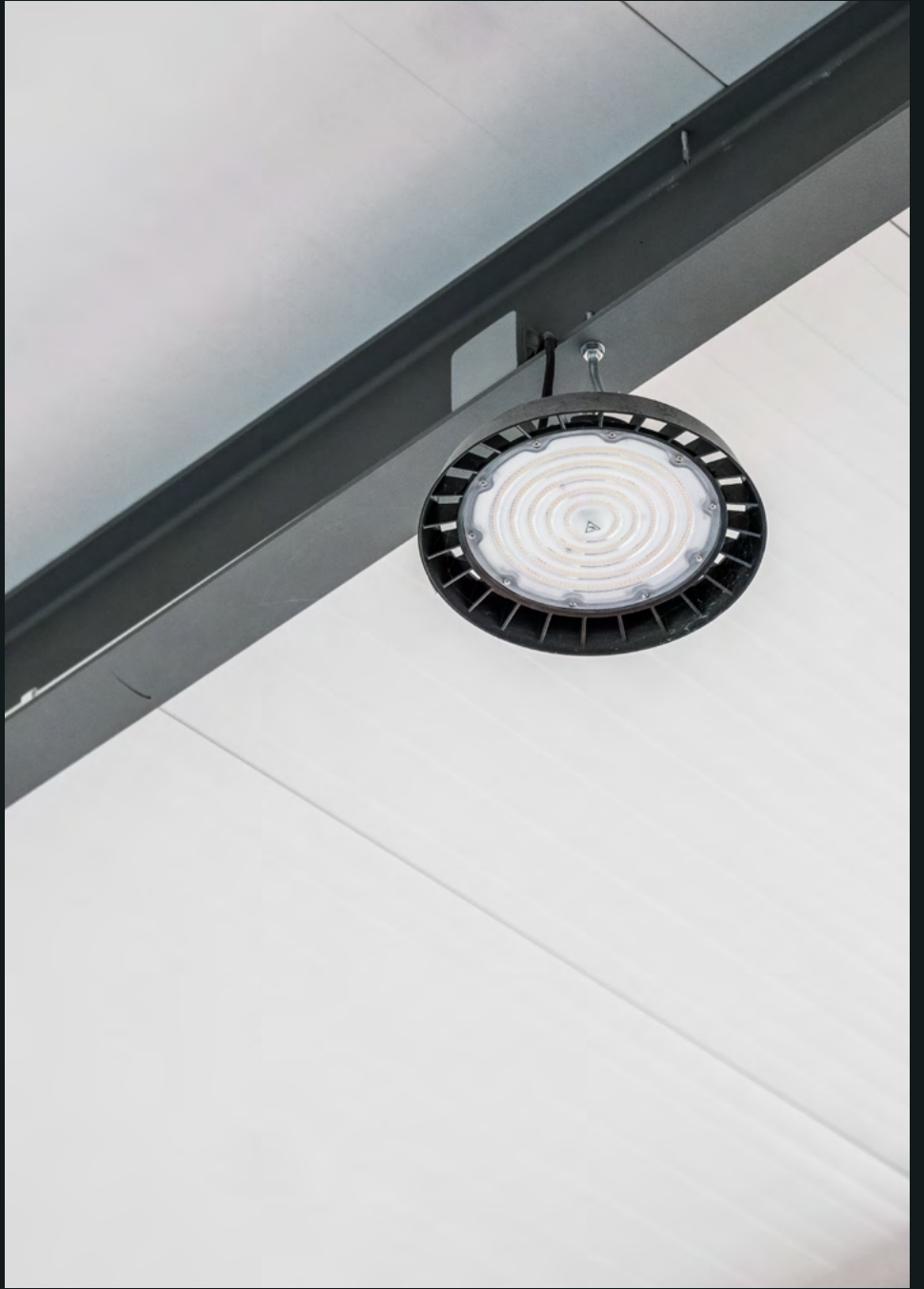







MIASTO OSTROLEK





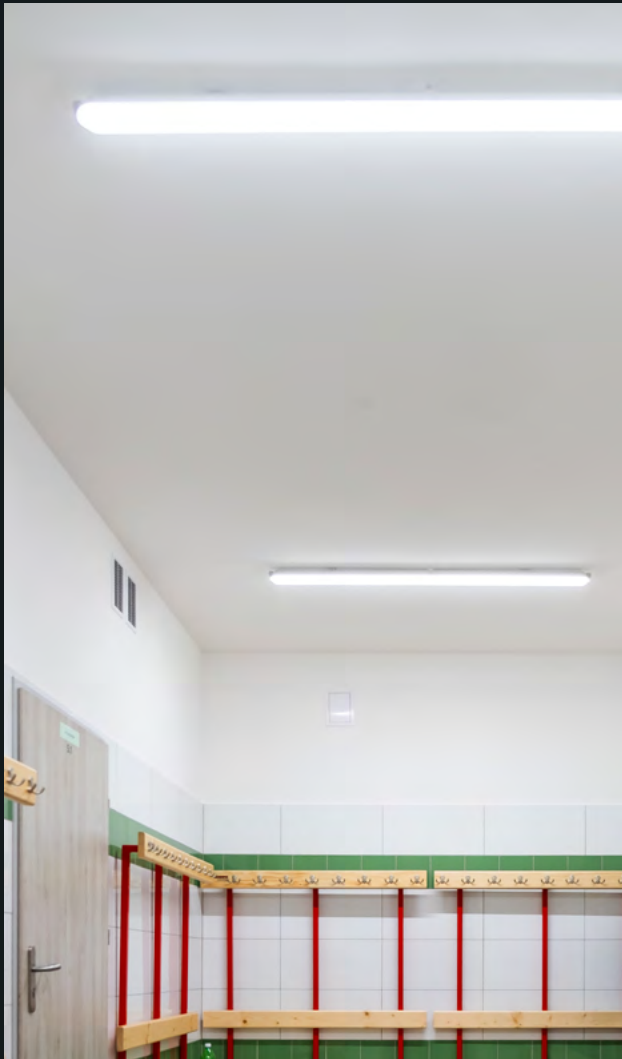









Solar
Jinko
Building Your Future in Solar

Solar
Jinko

Solar
Jinko
Building Your Future in Solar



























CAMINO 106

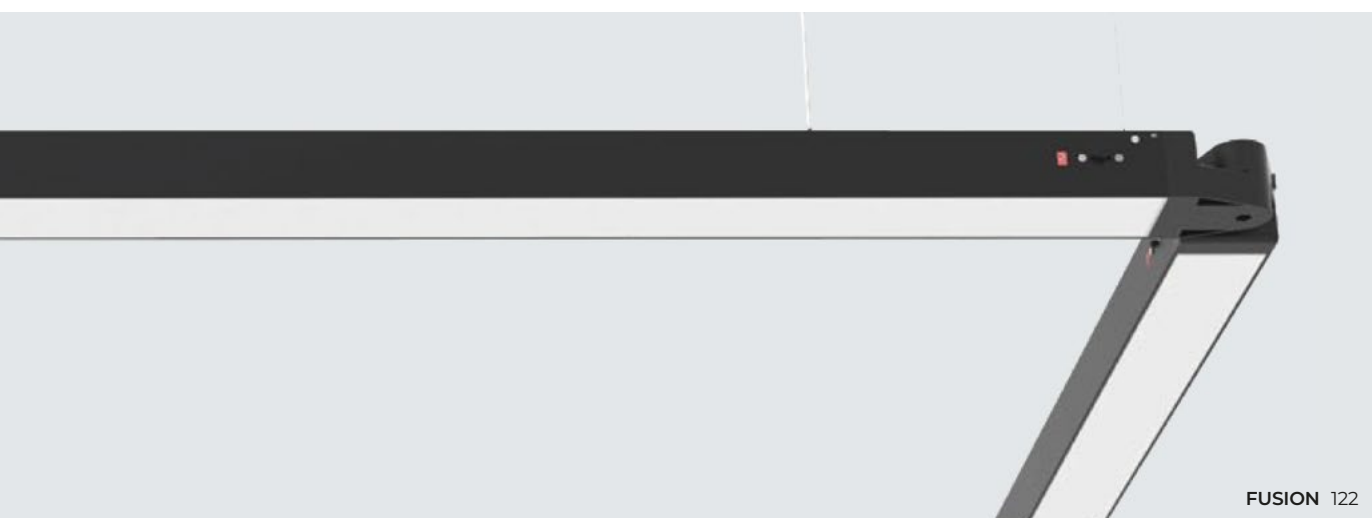

FUSION 122

Oprawy oświetleniowe LED line są projektowane z myślą o niezawodności i wysokiej wydajności. Każda oprawa przechodzi szczegółowe testy laboratoryjne, które mają na celu zapewnienie pełnej zgodności z deklarowanymi parametrami technicznymi. Szczególną uwagę zwracamy na dokładność pomiaru strumienia świetlnego, który mierzony jest jako całkowity strumień emitowany przez oprawę. Dodatkowo uwzględniany jest użyteczny strumień świetlny, kluczowy dla efektywności oświetlenia. Wybierając oprawy LED line, zyskujesz pewność, że każdy produkt został poddany rygorystycznym badaniom i spełnia najwyższe standardy jakości.



BACKLIT 166

NOLINA 100



PHANTOM 66



MOLLY 184

KATEGORIE PRODUKTÓW

NAŚWIETLACZE

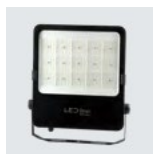

FLOODLIGHT
PRIME

48



PHOTON

53



LUMINO

59

HIGH BAY

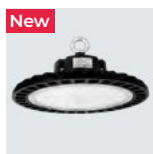

PHANTOM

66



RAIDER

72



ECOBELM

74

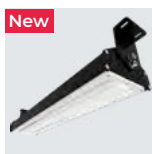

STREAKBAY

76

OPRAWY SUFITOWE



LUNAR

80



ACTON

84



PLAFON IP44

86



RANGER

92



LINKER

94



TRI-PROOF

98

TRI-PROOF

OPRAWY PARKOWE

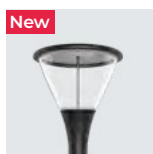

NOLINA

100

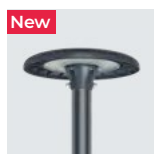

PARKLITE

102

OPRAWY DROGOWE



ELIDA

104

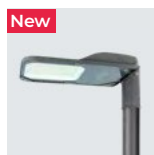

CAMINO

106

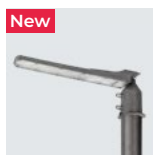

FLAMINGO

108



STREETLITE

112

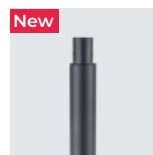

SKŁADANY SŁUP
OŚWIETLENIOWY

114

KINKIETY ZEWNĘTRZNE



CUBE
120



CILINDER
120

OPRAWY LINIOWE



FUSION
122

TAŚMY LED



COB
133



EXPERT
137

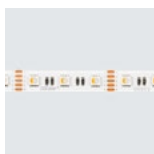

CLASSIC
140



WATERPROOF
145



AKCESORIA
150

PANELE LED

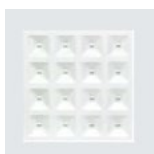

DIORA
158



PANEL 2in1
160



PANEL SLIM
164



BACKLIT
166



AKCESORIA
170

DOWNLIGHT

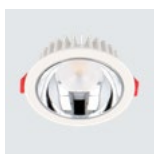

QUANTUM
172



CALMOS
174



EASY FIX PRO
176



EASY FIX
180



MOLLY
184

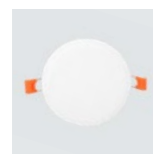

FRAMELESS
190

ŹRÓDŁA ŚWIATŁA LED



CERAMIC
194



GLASS
204

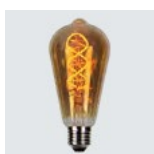

FILAMENT
209



BASIC
214

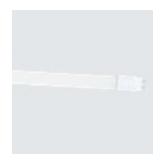

T8 LED
220

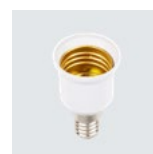

AKCESORIA
222

DEKORACYJNE



TAZA
226



CAMELIA
228



RIWIA
230

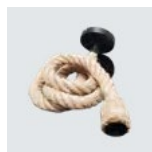

JUTE
232

OPRAWKI SUFITOWE



PIPE
192



CLASSIC
234

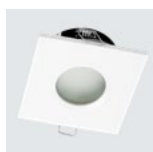

WATERPROOF
239



ROLLO
242



CUBO
244

MODUŁY LED



EXPERT
246

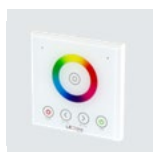

PILOTY
249



VARIANTE
253

ZASILACZE LED



WATERPROOF
257

























MULTIPOWER
261















































PROFILE ALUMINIOWE
264

PROFILE LED

IKONY

	Klasa efektywności energetycznej		Kąt wiązki światła		ENEC 18
	Producent udziela X-letniej gwarancji na ten produkt.		Regulacja kąta w osi X		Szybki złącznik
	Oprawę można regulować w zakresie X-X V		Regulacja kąta oświetlenia ulicznego		Produkt zaprojektowany do szybkiego montażu
	Regulacja kąta w osi Y		Certyfikowane przez Polski Instytut Zdrowia		Bez efektu migotania
	Kostka 0-120°		Sterownik		Konstrukcja tego produktu zapewnia efektywną dyssypację ciepła
	Ilość diod LED (na 1 metr)		Szczotkowane wykończenie oprawy		Wysoki wskaźnik oddawania barw (CRI)
	2w1 podtynkowe i natynkowe		Temperatura barwowa (CCT)		Klasa ochrony IEC I dla zasilaczy
	Kontroler 3CCT		Sekcja cięcia		Klasa ochrony IEC II dla zasilaczy
	Rodzaj taśmy klejącej		Taśma oparta na protokole SPI i komponencie WS2811		Klasa ochrony IEC III dla zasilaczy
	Zakres temperatury barwowej produktu mieści się w X krokach według formuły MacAdam		DIM TO WARM		Dostępne są pliki fotometryczne na podstawie testów fotometrycznych
	6 soczewek		Funkcja STEP DIMMABLE		Do użytku wewnętrznego
	Materiał (obudowa)		Odległość od oświetlonej powierzchni		Do użytku wewnętrznego i zewnętrznego
	Regulowana oprawa		Możliwe metody instalacji: podtynkowa i natynkowa		Klasa ochrony IP
	Regulowany uchwyt		Typ diod LED		Ilość diod LED
	LGP (Light Guide Plate)		Laminat (grubość)		Stand by
	Skuteczność świetlna typu LED		Materiał wysokiej jakości, odporny na żółknięcie spowodowane degradacją UV		LED Typ

 PF X,X	Współczynnik mocy	 voltage xxxxxxx	Napięcie range i Napięcie Typ	 SURFACE	Instalacja nadtynkowa
	Czujnik światła	 RECESSED	Ten produkt nadaje się do montażu podtynkowego	 TÜV	Certyfikacja TÜV
	Wydłużona żywotność produktu		Produkt jest regulowany pionowo i poziomo	 Powered By tuya	Sterowanie światłem za pomocą smartfona przez system IoT TUYA
	Niski UGR	 RF 2.4GHz	RF 2.4GHz	 COMPATIBLE WITH tuya CONTROLLERS	Kompatybilny z kontrolerami VARIANTE z systemem TUYA
	Produkt z obniżonym spadkiem napięcia	 RF 20m	RF 20m	 Powered By tuya	Sterowanie światłem za pomocą smartfona przez system IoT TUYA
	Produkt pokryty matowym wykończeniem malarskim	 RF REMOTE	Pilot RF		Rodzaj powierzchni odpowiedni do instalacji
	Temperatura otoczenia odpowiednia do pracy		Ta taśma LED produkuje światło z palety kolorów RGB	 ULOR X%	ULOR - wartość procentowa pokazująca procent światła wysyłanego do górnej półkuli
	Typ czujnika		Paleta kolorów RGB i dodatkowy chip „W”		Ultra cienki
	Kąt detekcji ruchu		Długość szpuli		Wysoka odporność na uszkodzenia mechaniczne i wandalizm
	Łatwy montaż bez konieczności demontażu ramienia		Średnica otworu montażowego	 Max ≤15A	Maksymalny prąd VARIANTE
	Temperatura barwowa z zakresu od 3000K do 6500K		Gwarancja wysokiego bezpieczeństwa użytkownika	 90-265V~ 50/60Hz	Napięcie AC VARIANTE
	Wąski kąt wiązki światła		Szlifowane wykończenie oprawy	 12V/24V ↓ ~180W/~360W	Napięcie AC VARIANTE
	Liczba cykli włączenia/wyłączenia		Smukły design		Stopień ochrony IK
	Wysokiej jakości diody LED marki XXXX		Średnica lampy		Wysoki stopień ochrony IP
	Trwałość oświetlenia LED jest określana za pomocą wskaźnika LxBy		Czujnik zmierzchu		

wydajność 140lm/W wersja CCT 6 soczewek 30°, 60°, 90°, 120°, T2, T3 hartowane szkło temperatura barwowa 3000K - 5000K wodoodporność IP66



wymienne soczewki

certyfikat testu korozyjnego w mgie solnej

funkcja AC

obudowa z odlewu aluminium

precyzyjna regulacja co 15°

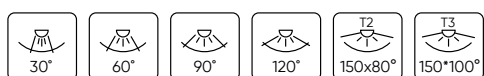

NAŚWIETLACZ FLOODLIGHT PRIME

FLOODLIGHT PRIME 30W 4200lm

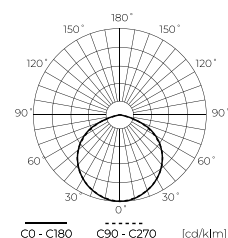
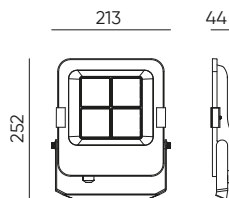
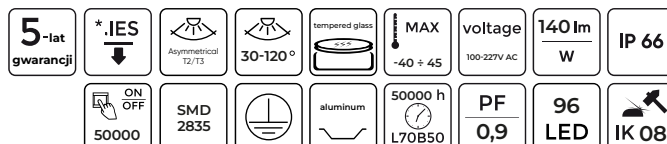

200203

200203

LED line PRIME

SYMBOL	NAZWA	KĄT ŚWIECENIA	MOC	TEMPERATURA BARWOWA	STRUMIEŃ ŚWIETLNY
200203	FLOODLIGHT PRIME 30W 4200lm 4000K 120°	120°	30W	4000K	4200lm
200289	FLOODLIGHT PRIME 30W 4200lm 4000K 90°	90°	30W	4000K	4200lm
200272	FLOODLIGHT PRIME 30W 4200lm 4000K 60°	60°	30W	4000K	4200lm
200265	FLOODLIGHT PRIME 30W 4200lm 4000K 30°	30°	30W	4000K	4200lm
202566	FLOODLIGHT PRIME 30W 4200lm 4000K T2	150*80°	30W	4000K	4200lm
202559	FLOODLIGHT PRIME 30W 4200lm 4000K T3	150*100°	30W	4000K	4200lm
202726	FLOODLIGHT PRIME 30W 4200lm CCT 120°	120°	30W	3000-4000-5000K	4200lm
202900	FLOODLIGHT PRIME 30W 4200lm CCT 30°	30°	30W	3000-4000-5000K	4200lm
202733	FLOODLIGHT PRIME 30W 4200lm CCT T2	150*80°	30W	3000-4000-5000K	4200lm

FLOODLIGHT PRIME 50W 7000lm

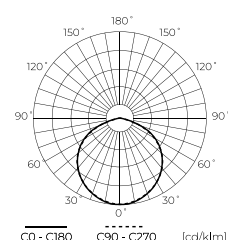
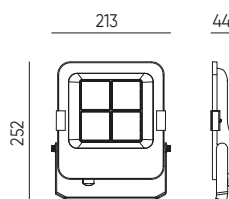
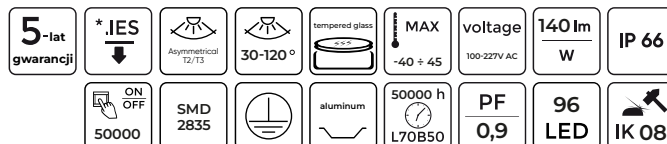

200210

200210

LED line PRIME

SYMBOL	NAZWA	KĄT ŚWIECENIA	MOC	TEMPERATURA BARWOWA	STRUMIEŃ ŚWIETLNY
200210	FLOODLIGHT PRIME 50W 7000lm 4000K 120°	120°	50W	4000K	7000lm
200319	FLOODLIGHT PRIME 50W 7000lm 4000K 90°	90°	50W	4000K	7000lm
200302	FLOODLIGHT PRIME 50W 7000lm 4000K 60°	60°	50W	4000K	7000lm
200296	FLOODLIGHT PRIME 50W 7000lm 4000K 30°	30°	50W	4000K	7000lm
202443	FLOODLIGHT PRIME 50W 7000lm 4000K T2	150*80°	50W	4000K	7000lm
202542	FLOODLIGHT PRIME 50W 7000lm 4000K T3	150*100°	50W	4000K	7000lm
202757	FLOODLIGHT PRIME 50W 7000lm CCT 120°	120°	50W	3000-4000-5000K	7000lm
202948	FLOODLIGHT PRIME 50W 7000lm CCT 30°	30°	50W	3000-4000-5000K	7000lm
202740	FLOODLIGHT PRIME 50W 7000lm CCT T2	150*80°	50W	3000-4000-5000K	7000lm

FLOODLIGHT 100W 14000lm

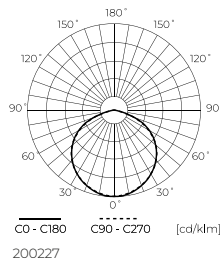
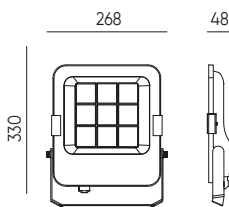
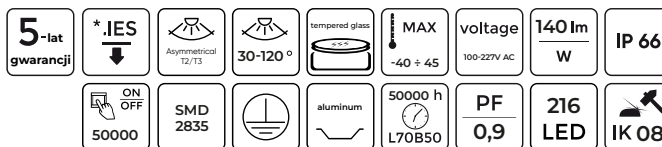

LED line PRIME

SYMBOL	NAZWA	KĄT ŚWIECENIA	MOC	TEMPERATURA BARWOWA	STRUMIEŃ ŚWIETLNY
200227	FLOODLIGHT PRIME 100W 14000lm 4000K 120°	120°	100W	4000K	14000lm
200340	FLOODLIGHT PRIME 100W 14000lm 4000K 90°	90°	100W	4000K	14000lm
200333	FLOODLIGHT PRIME 100W 14000lm 4000K 60°	60°	100W	4000K	14000lm
200326	FLOODLIGHT PRIME 100W 14000lm 4000K 30°	30°	100W	4000K	14000lm
202450	FLOODLIGHT PRIME 100W 14000lm 4000K T2	150*80°	100W	4000K	14000lm
202528	FLOODLIGHT PRIME 100W 14000lm 4000K T3	150*100°	100W	4000K	14000lm
202764	FLOODLIGHT PRIME 100W 14000lm CCT 120°	120°	100W	3000-4000-5000K	14000lm
202986	FLOODLIGHT PRIME 100W 14000lm CCT 30°	30°	100W	3000-4000-5000K	14000lm
202771	FLOODLIGHT PRIME 100W 14000lm CCT T2	150*80°	100W	3000-4000-5000K	14000lm

FLOODLIGHT 150W 21000lm

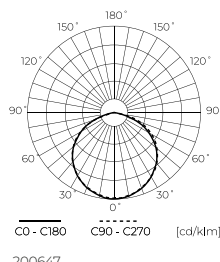
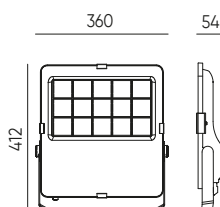
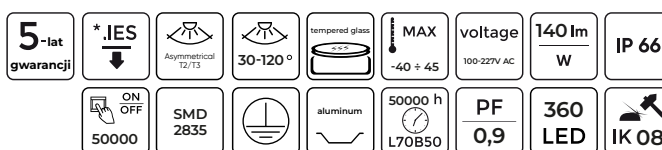

LED line PRIME

SYMBOL	NAZWA	KĄT ŚWIECENIA	MOC	TEMPERATURA BARWOWA	STRUMIEŃ ŚWIETLNY
200647	FLOODLIGHT PRIME 150W 21000lm 4000K 120°	120°	150W	4000K	21000lm
202610	FLOODLIGHT PRIME 150W 21000lm 4000K 90°	90°	150W	4000K	21000lm
200654	FLOODLIGHT PRIME 150W 21000lm 4000K 60°	60°	150W	4000K	21000lm
202603	FLOODLIGHT PRIME 150W 21000lm 4000K 30°	30°	150W	4000K	21000lm
202580	FLOODLIGHT PRIME 150W 21000lm 4000K T2	150*80°	150W	4000K	21000lm
202627	FLOODLIGHT PRIME 150W 21000lm 4000K T3	150*100°	150W	4000K	21000lm
202788	FLOODLIGHT PRIME 150W 21000lm CCT 120°	120°	150W	3000-4000-5000K	21000lm
203020	FLOODLIGHT PRIME 150W 21000lm CCT 30°	30°	150W	3000-4000-5000K	21000lm
202795	FLOODLIGHT PRIME 150W 21000lm CCT T2	150*80°	150W	3000-4000-5000K	21000lm

FLOODLIGHT 200W 28000lm



LED line PRIME

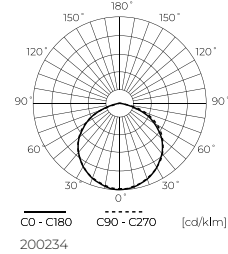
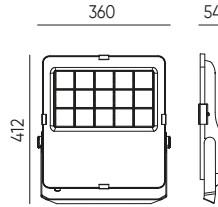
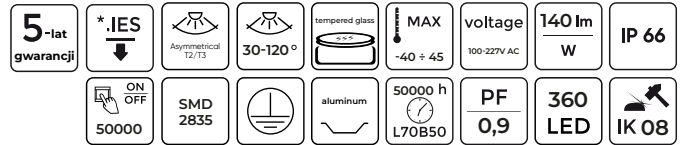

200234

SYMBOL	NAZWA	KĄT ŚWIECENIA	MOC	TEMPERATURA BARWOWA	STRUMIEN ŚWIETLNY
200234	FLOODLIGHT PRIME 200W 28000lm 4000K 120°	120°	200W	4000K	28000lm
200371	FLOODLIGHT PRIME 200W 28000lm 4000K 90°	90°	200W	4000K	28000lm
200364	FLOODLIGHT PRIME 200W 28000lm 4000K 60°	60°	200W	4000K	28000lm
200357	FLOODLIGHT PRIME 200W 28000lm 4000K 30°	30°	200W	4000K	28000lm
202467	FLOODLIGHT PRIME 200W 28000lm 4000K T2	150*80°	200W	4000K	28000lm
202535	FLOODLIGHT PRIME 200W 28000lm 4000K T3	150*100°	200W	4000K	28000lm
202801	FLOODLIGHT PRIME 200W 28000lm CCT 120°	120°	200W	3000-4000-5000K	28000lm
203068	FLOODLIGHT PRIME 200W 28000lm CCT 30°	30°	200W	3000-4000-5000K	28000lm
202818	FLOODLIGHT PRIME 200W 28000lm CCT T2	150*80°	200W	3000-4000-5000K	28000lm

FLOODLIGHT 400W 56000lm



LED line PRIME

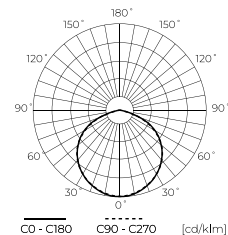
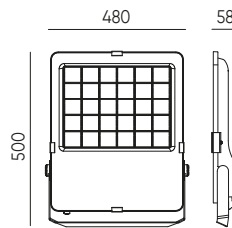
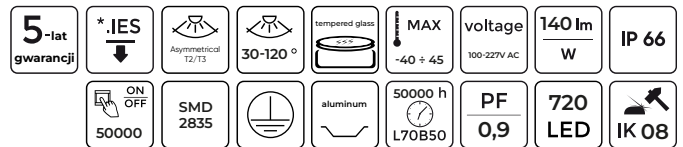

200241

SYMBOL	NAZWA	KĄT ŚWIECENIA	MOC	TEMPERATURA BARWOWA	STRUMIEN ŚWIETLNY
200241	FLOODLIGHT PRIME 400W 56000lm 4000K 120°	120°	400W	4000K	56000lm
202689	FLOODLIGHT PRIME 400W 56000lm 4000K 90°	90°	400W	4000K	56000lm
202672	FLOODLIGHT PRIME 400W 56000lm 4000K 60°	60°	400W	4000K	56000lm
202665	FLOODLIGHT PRIME 400W 56000lm 4000K 30°	30°	400W	4000K	56000lm
200401	FLOODLIGHT PRIME 400W 56000lm 4000K T2	150*80°	400W	4000K	56000lm
202696	FLOODLIGHT PRIME 400W 56000lm 4000K T3	150*100°	400W	4000K	56000lm

FLOODLIGHT 600W 84000lm

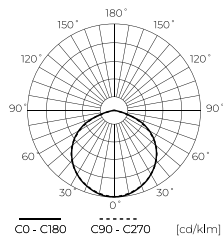
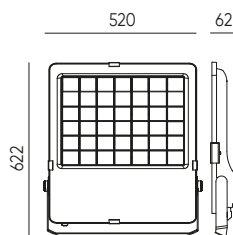
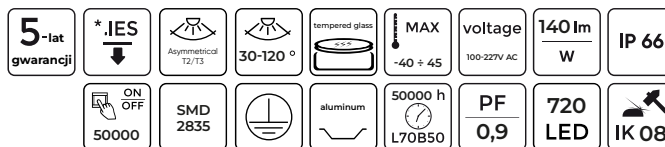

LED line PRIME

SYMBOL	NAZWA	KĄT ŚWIECENIA	MOC	TEMPERATURA BARWOWA	STRUMIEŃ ŚWIETLNY
200258	FLOODLIGHT PRIME 600W 4000K 84000lm 120°	120°	600W	4000K	84000lm
202658	FLOODLIGHT PRIME 600W 4000K 84000lm 90°	90°	600W	4000K	84000lm
202641	FLOODLIGHT PRIME 600W 4000K 84000lm 60°	60°	600W	4000K	84000lm
202634	FLOODLIGHT PRIME 600W 4000K 84000lm 30°	30°	600W	4000K	84000lm
202597	FLOODLIGHT PRIME 600W 4000K 84000lm T2	150*80°	600W	4000K	84000lm
200418	FLOODLIGHT PRIME 600W 4000K 84000lm T3	150*100°	600W	4000K	84000lm



NAŚWIETLACZ PHOTON

Naświetlacz PHOTON 10W 1000lm 4000K

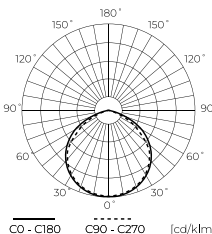
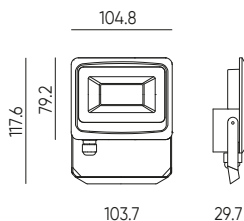
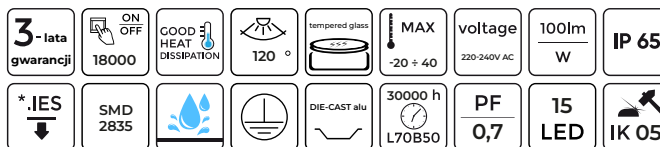

LED line LITE

SYMBOL	NAZWA	KĄT ŚWIECENIA	MOC	TEMPERATURA BARWOWA	STRUMIEN ŚWIETLNY
203495	Naświetlacz PHOTON 10W 1000lm 4000K	120°	10W	4000K	1000lm

Naświetlacz PHOTON 20W 2000lm 4000K

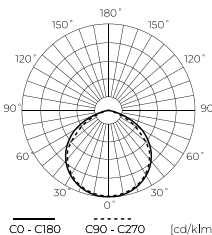
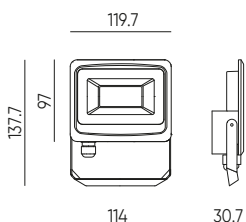
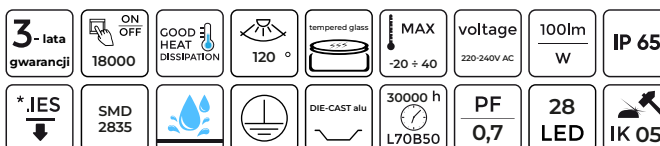

LED line LITE

SYMBOL	NAZWA	KĄT ŚWIECENIA	MOC	TEMPERATURA BARWOWA	STRUMIEN ŚWIETLNY
203518	Naświetlacz PHOTON 20W 2000lm 4000K	120°	20W	4000K	2000lm

Naświetlacz PHOTON 30W 3000lm 4000K

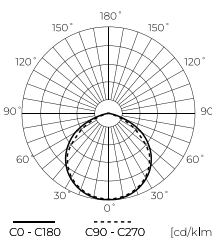
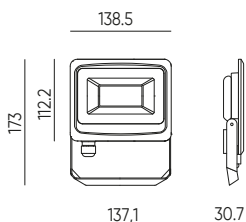
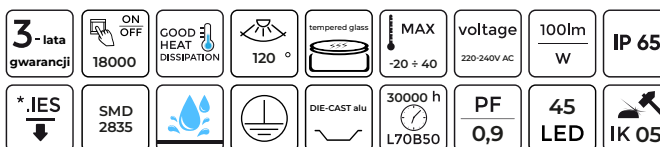

LED line LITE

SYMBOL	NAZWA	KĄT ŚWIECENIA	MOC	TEMPERATURA BARWOWA	STRUMIEN ŚWIETLNY
203525	Naświetlacz PHOTON 30W 3000lm 4000K	120°	30W	4000K	3000lm

Naświetlacz PHOTON 50W 5000lm 4000K

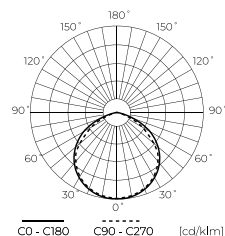
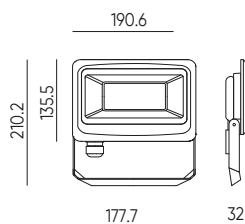
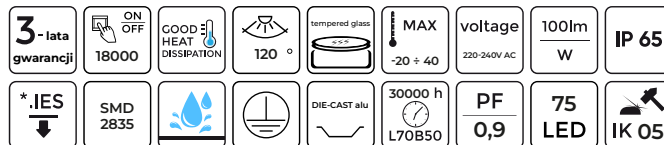

LED line LITE

SYMBOL	NAZWA	KĄT ŚWIECENIA	MOC	TEMPERATURA BARWOWA	STRUMIEŃ ŚWIETLNY
203549	Naświetlacz PHOTON 50W 5000lm 4000K	120°	50W	4000K	5000lm

Naświetlacz PHOTON 100W 10000lm 4000K

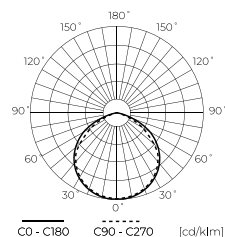
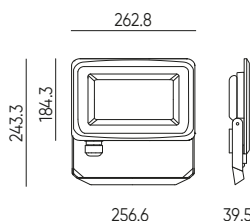
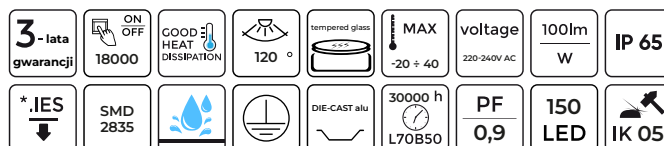

LED line LITE

SYMBOL	NAZWA	KĄT ŚWIECENIA	MOC	TEMPERATURA BARWOWA	STRUMIEŃ ŚWIETLNY
203563	Naświetlacz PHOTON 100W 10000lm 4000K	120°	100W	4000K	10000lm

Naświetlacz PHOTON 10W 1000lm z czujnikiem ruchu

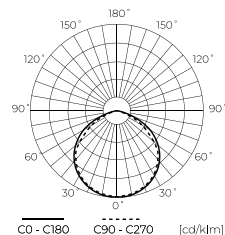
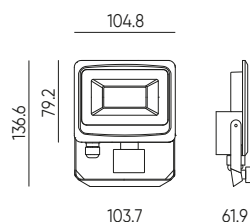
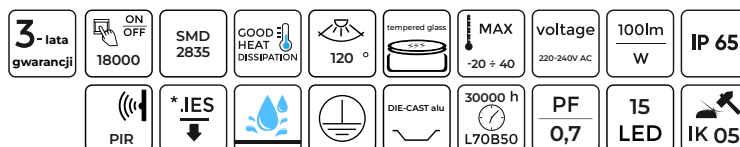

LED line LITE

SYMBOL	NAZWA	KĄT ŚWIECENIA	MOC	TEMPERATURA BARWOWA	STRUMIEŃ ŚWIETLNY
203501	Naświetlacz PHOTON 10W 1000lm 4000K z czujnikiem ruchu	120°	10W	4000K	1000lm

Naświetlacz PHOTON 20W 2000lm 4000K z czujnikiem ruchu

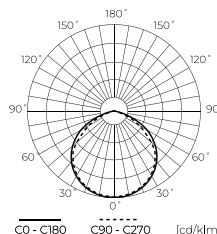
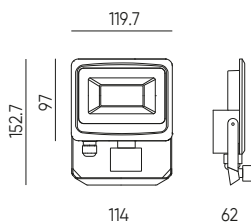
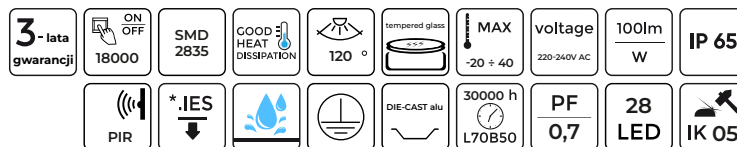

LED line LITE

SYMBOL	NAZWA	KĄT ŚWIECENIA	MOC	TEMPERATURA BARWOWA	STRUMIEŃ ŚWIETLNY
203488	Naświetlacz PHOTON 20W 2000lm 4000K z czujnikiem ruchu	120°	20W	4000K	2000lm

Naświetlacz PHOTON 30W 3000lm 4000K z czujnikiem ruchu

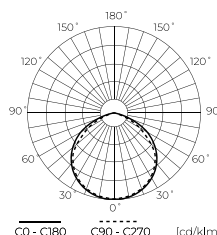
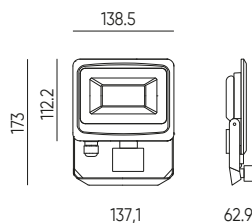
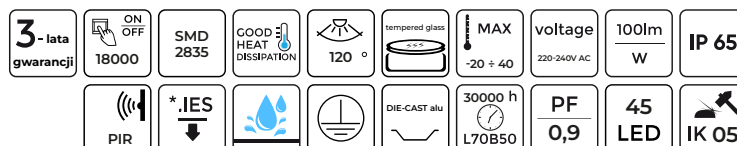

LED line LITE

SYMBOL	NAZWA	KĄT ŚWIECENIA	MOC	TEMPERATURA BARWOWA	STRUMIEŃ ŚWIETLNY
203532	Naświetlacz PHOTON 30W 3000lm 4000K z czujnikiem ruchu	120°	30W	4000K	3000lm

Naświetlacz PHOTON 50W 5000lm 4000K z czujnikiem ruchu

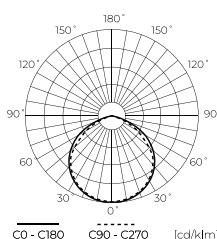
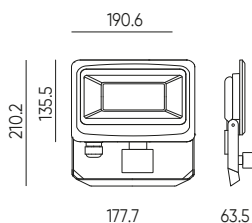
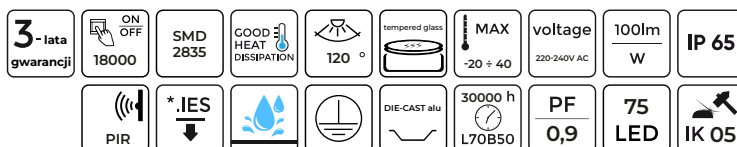

LED line LITE

SYMBOL	NAZWA	KĄT ŚWIECENIA	MOC	TEMPERATURA BARWOWA	STRUMIEŃ ŚWIETLNY
203556	Naświetlacz PHOTON 50W 5000lm 4000K z czujnikiem ruchu	120°	50W	4000K	5000lm

Naświetlacz PHOTON 100W 10000lm 4000K z czujnikiem ruchu

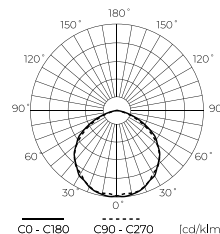
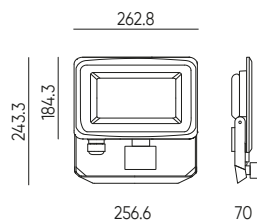
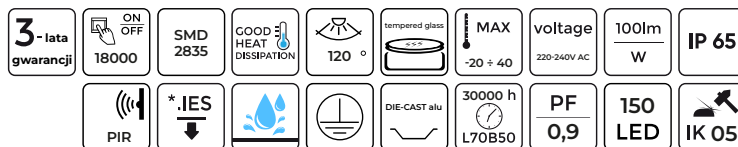

LED line LITE

SYMBOL	NAZWA	KĄT ŚWIECENIA	MOC	TEMPERATURA BARWOWA	STRUMIEŃ ŚWIETLNY
203747	Naświetlacz PHOTON 100W 10000lm 4000K z czujnikiem ruchu	120°	100W	4000K	10000lm

Naświetlacz PHOTON 50W AC RGB

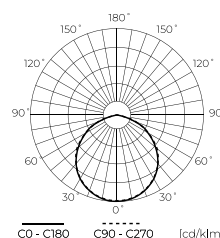
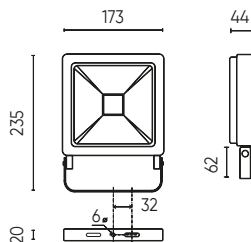
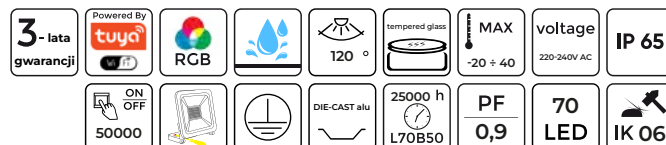

LED line LITE

SYMBOL	NAZWA	KĄT ŚWIECENIA	MOC
470492	Naświetlacz PHOTON 50W RGB	120°	50W

Naświetlacz PHOTON 10W 800lm 6000K AC z czujnikiem ruchu

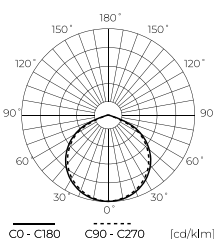
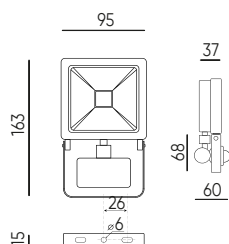
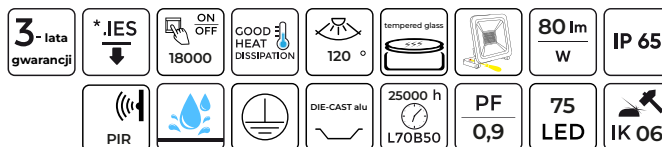

LED line LITE

SYMBOL	NAZWA	KĄT ŚWIECENIA	MOC	TEMPERATURA BARWOWA	STRUMIEŃ ŚWIETLNY
476999	Naświetlacz PHOTON 10W 800lm 6000K AC z czujnikiem ruchu	120°	10W	6000K	800lm

Naświetlacz PHOTON 30W 2400lm 6000K AC z czujnikiem ruchu

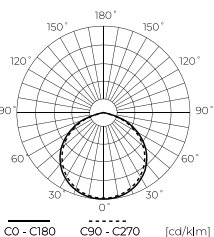
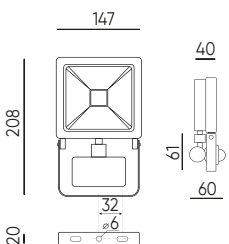
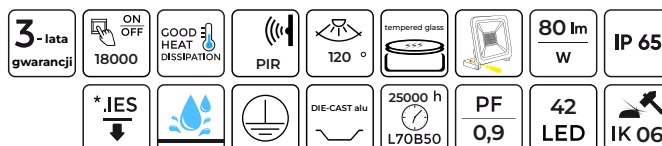

LED line LITE

SYMBOL	NAZWA	KĄT ŚWIECENIA	MOC	TEMPERATURA BARWOWA	STRUMIEŃ ŚWIETLNY
477019	Naświetlacz PHOTON 30W 2400lm 6000K AC z czujnikiem ruchu	120°	30W	6000K	2400lm

Naświetlacz PHOTON 50W 4000lm 6000K AC z czujnikiem ruchu

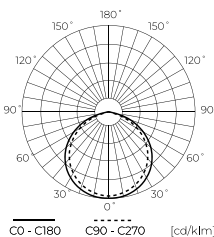
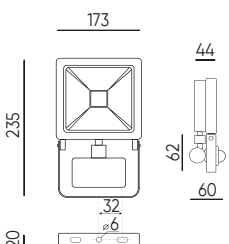
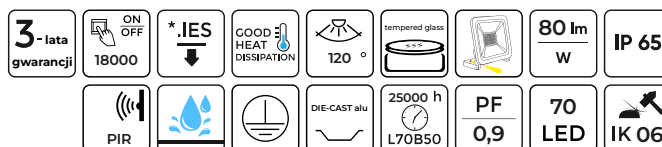

LED line LITE

SYMBOL	NAZWA	KĄT ŚWIECENIA	MOC	TEMPERATURA BARWOWA	STRUMIEŃ ŚWIETLNY
477026	Naświetlacz PHOTON 50W 4000lm 6000K AC z czujnikiem ruchu	120°	50W	6000K	4000lm



NAŚWIETLACZ
LUMINO

Naświetlacz LUMINO 10W 1000lm 4000K

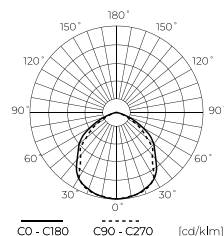
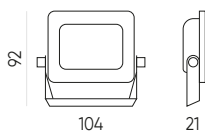
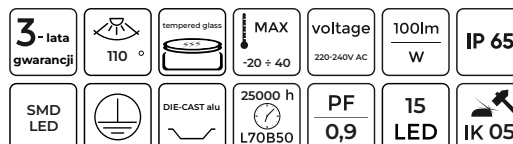

LED line LITE

SYMBOL	NAZWA	KĄT ŚWIECENIA	MOC	TEMPERATURA BARWOWA	STRUMIEŃ ŚWIETLNY
203280	Naświetlacz LUMINO 10W 1000lm 4000K	110°	10W	4000K	1000lm

Naświetlacz LUMINO 20W 2000lm 4000K

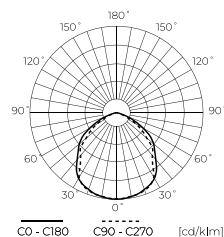
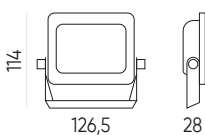
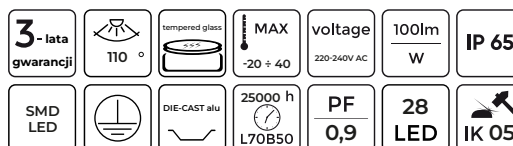

LED line LITE

SYMBOL	NAZWA	KĄT ŚWIECENIA	MOC	TEMPERATURA BARWOWA	STRUMIEŃ ŚWIETLNY
203297	Naświetlacz LUMINO 20W 2000lm 4000K	110°	20W	4000K	2000lm

Naświetlacz LUMINO 30W 3000lm 4000K

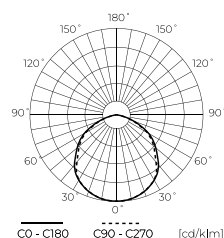
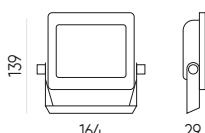
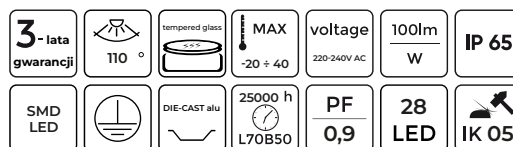

LED line LITE

SYMBOL	NAZWA	KĄT ŚWIECENIA	MOC	TEMPERATURA BARWOWA	STRUMIEŃ ŚWIETLNY
203303	Naświetlacz LUMINO 30W 3000lm 4000K	110°	30W	4000K	3000lm

Naświetlacz LUMINO 50W 5000lm 4000K

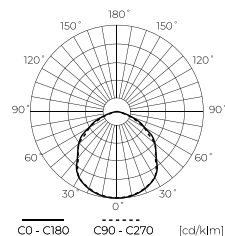
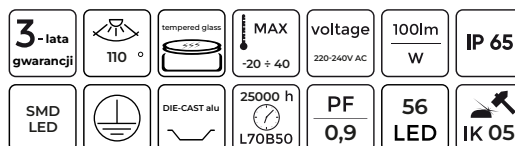
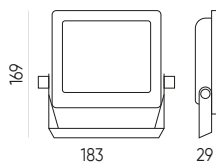

LED line LITE

SYMBOL	NAZWA	KĄT ŚWIECENIA	MOC	TEMPERATURA BARWOWA	STRUMIEŃ ŚWIETLNY
203310	Naświetlacz LUMINO 50W 5000lm 4000K	110°	50W	4000K	5000lm

Naświetlacz LUMINO 100W 10000lm 4000K

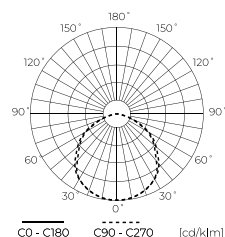
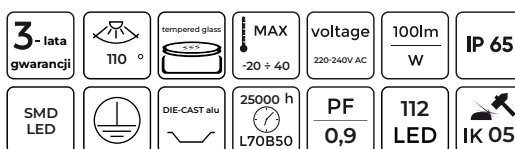
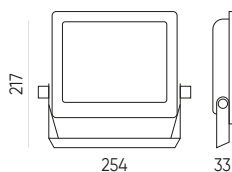

LED line LITE

SYMBOL	NAZWA	KĄT ŚWIECENIA	MOC	TEMPERATURA BARWOWA	STRUMIEŃ ŚWIETLNY
203327	Naświetlacz LUMINO 100W 10000lm 4000K	110°	100W	4000K	10000lm

Naświetlacz LUMINO 150W 15000lm 4000K

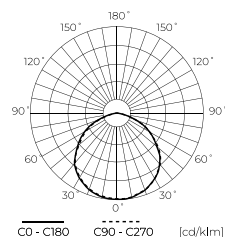
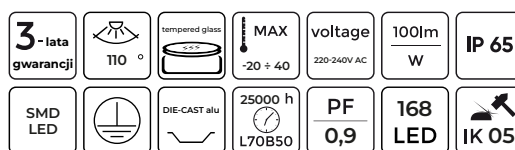
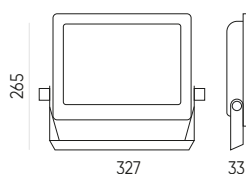

LED line LITE

SYMBOL	NAZWA	KĄT ŚWIECENIA	MOC	TEMPERATURA BARWOWA	STRUMIEŃ ŚWIETLNY
203334	Naświetlacz LUMINO 150W 15000lm 4000K	110°	150W	4000K	15000lm

Naświetlacz LUMINO 200W 20000lm 4000K

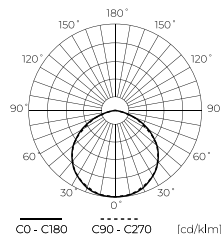
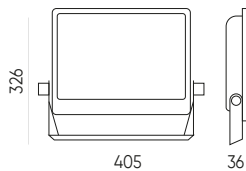
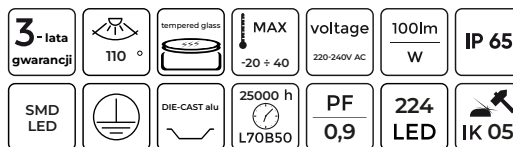

LED line LITE

SYMBOL	NAZWA	KĄT ŚWIECENIA	MOC	TEMPERATURA BARWOWA	STRUMIEŃ ŚWIETLNY
203341	Naświetlacz LUMINO 200W 20000lm 4000K	110°	200W	4000K	20000lm

Naświetlacz LUMINO 10W 1000lm 4000K z czujnikiem ruchu

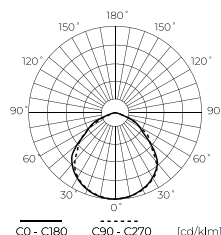
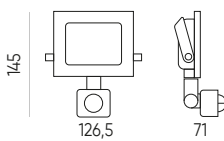
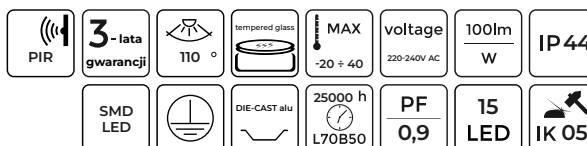

LED line LITE

SYMBOL	NAZWA	KĄT ŚWIECENIA	MOC	TEMPERATURA BARWOWA	STRUMIEŃ ŚWIETLNY
203358	Naświetlacz LUMINO 10W 1000lm 4000K z czujnikiem ruchu	110°	10W	4000K	1000lm

Naświetlacz LUMINO 20W 2000lm 4000K z czujnikiem ruchu

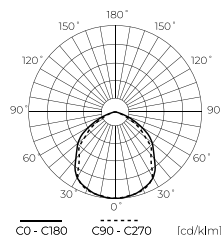
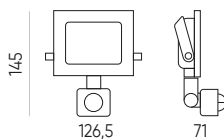
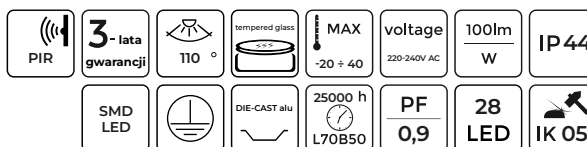

LED line LITE

SYMBOL	NAZWA	KĄT ŚWIECENIA	MOC	TEMPERATURA BARWOWA	STRUMIEŃ ŚWIETLNY
203365	Naświetlacz LUMINO 20W 2000lm 4000K z czujnikiem ruchu	110°	20W	4000K	2000lm

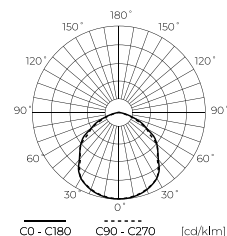
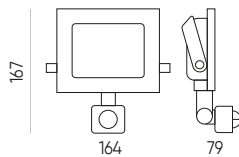
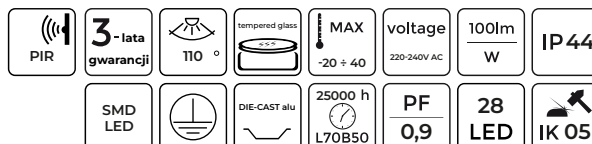
Naświetlacz LUMINO 30W 3000lm 4000K z czujnikiem ruchu

LED line LITE

SYMBOL	NAZWA	KĄT ŚWIECENIA	MOC	TEMPERATURA BARWOWA	STRUMIEŃ ŚWIETLNY
203372	Naświetlacz LUMINO 30W 3000lm 4000K z czujnikiem ruchu	110°	30W	4000K	3000lm

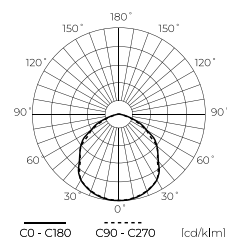
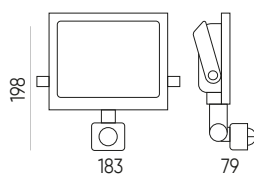
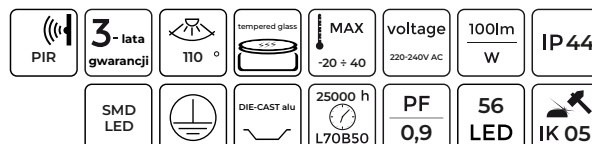
Naświetlacz LUMINO 50W 5000lm 4000K z czujnikiem ruchu

LED line LITE

SYMBOL	NAZWA	KĄT ŚWIECENIA	MOC	TEMPERATURA BARWOWA	STRUMIEŃ ŚWIETLNY
203389	Naświetlacz LUMINO 50W 5000lm 4000K z czujnikiem ruchu	110°	50W	4000K	5000lm







moc
70-200W

funkcja ściemniania
1-10V w standardzie
bez dodatkowych kosztów

wydajność
190lm/W

najwyższa wydajność
na rynku

3 typy soczewek
60°, 90°, 120°

L90B50 - 50.000h
L70B50 - 100.000h

HIGH BAY PHANTOM



High bay PHANTOM 70W 13300lm 4000K 1-10V

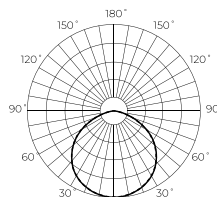
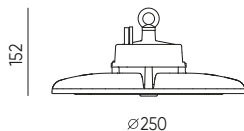

CO - C180 C90 - C270 [cd/klm]
206588



206588

LED line PRIME

SYMBOL	NAZWA	KĄT ŚWIECENIA	MOC	TEMPERATURA BARWOWA	STRUMIEŃ ŚWIETLNY
206588 New	High bay PHANTOM 190 70W 13300lm 4000K 1-10V	120°	70W	4000K	13300lm
206595 New	High bay PHANTOM 190 70W 13300lm 4000K 1-10V	90°	70W	4000K	13300lm
206601 New	High bay PHANTOM 190 70W 13300lm 4000K 1-10V	60°	70W	4000K	13300lm

High bay PHANTOM 100W 19000lm 4000K 1-10V

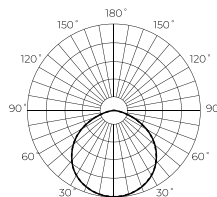
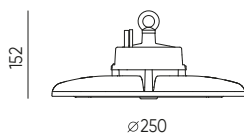

CO - C180 C90 - C270 [cd/klm]
203143



203143

LED line PRIME

SYMBOL	NAZWA	KĄT ŚWIECENIA	MOC	TEMPERATURA BARWOWA	STRUMIEŃ ŚWIETLNY
203143	High bay PHANTOM 190 100W 19000lm 4000K 1-10V	120°	100W	4000K	19000lm
203150	High bay PHANTOM 190 100W 19000lm 4000K 1-10V	90°	100W	4000K	19000lm
203167	High bay PHANTOM 190 100W 19000lm 4000K 1-10V	60°	100W	4000K	19000lm

High bay PHANTOM 150W 28500lm 4000K 1-10V

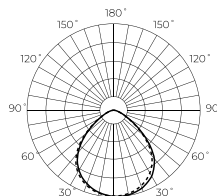
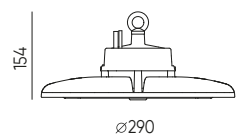

CO - C180 C90 - C270 [cd/klm]
203174



203174

LED line PRIME

SYMBOL	NAZWA	KĄT ŚWIECENIA	MOC	TEMPERATURA BARWOWA	STRUMIEŃ ŚWIETLNY
203174	High bay PHANTOM 190 150W 28500lm 4000K 1-10V	120°	150W	4000K	28500lm
203181	High bay PHANTOM 190 150W 28500lm 4000K 1-10V	90°	150W	4000K	28500lm
203198	High bay PHANTOM 190 150W 28500lm 4000K 1-10V	60°	150W	4000K	28500lm

High bay PHANTOM 200W 38000lm 4000K 1-10V

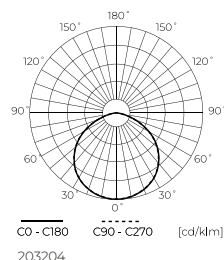
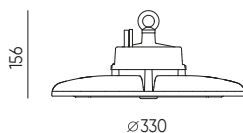
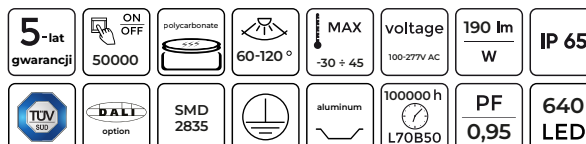

LED line PRIME

SYMBOL	NAZWA	KĄT ŚWIECENIA	MOC	TEMPERATURA BARWOWA	STRUMIEŃ ŚWIETLNY
203204	High bay PHANTOM 190 200W 38000lm 4000K 1-10V	120°	200W	4000K	38000lm
203211	High bay PHANTOM 190 200W 38000lm 4000K 1-10V	90°	200W	4000K	38000lm
203228	High bay PHANTOM 190 200W 38000lm 4000K 1-10V	60°	200W	4000K	38000lm

High Bay PHANTOM 100W 19000lm 4000K 1-10V z czujnikiem ruchu

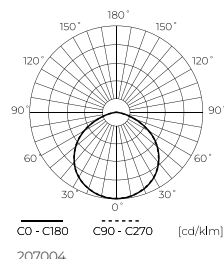
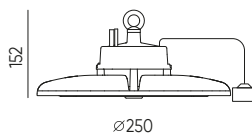
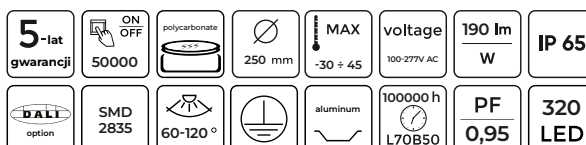

LED line PRIME

SYMBOL	NAZWA	KĄT ŚWIECENIA	MOC	TEMPERATURA BARWOWA	STRUMIEŃ ŚWIETLNY
207004 New	High bay PHANTOM 190 100W 19000lm 4000K 1-10V z czujnikiem ruchu	120°	100W	4000K	19000lm
207011 New	High bay PHANTOM 190 100W 19000lm 4000K 1-10V z czujnikiem ruchu	90°	100W	4000K	19000lm
207028 New	High bay PHANTOM 190 100W 19000lm 4000K 1-10V z czujnikiem ruchu	60°	100W	4000K	19000lm

High bay PHANTOM 150W 28500lm 4000K 1-10V z czujnikiem ruchu

5-lat gwarancji	ON OFF 50000	polycarbonate	60-120°	290 mm	MAX -30 ÷ 45	voltage 100-277V AC	190 lm W	IP 65
DALI option	SMD 2835			polycarbonate	aluminum	100000 h L70B50	PF 0,95	480 LED

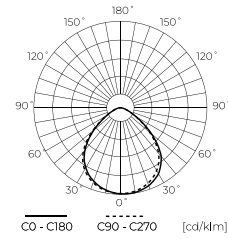
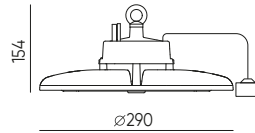

207035

LED line PRIME

SYMBOL	NAZWA	KĄT ŚWIECENIA	MOC	TEMPERATURA BARWOWA	STRUMIEŃ ŚWIETLNY
207035 New	High bay PHANTOM 190 150W 28500lm 4000K 1-10V z czujnikiem ruchu	120°	150W	4000K	28500lm
207042 New	High bay PHANTOM 190 150W 28500lm 4000K 1-10V z czujnikiem ruchu	90°	150W	4000K	28500lm
207059 New	High bay PHANTOM 190 150W 28500lm 4000K 1-10V z czujnikiem ruchu	60°	150W	4000K	28500lm

High bay PHANTOM 200W 38000lm 4000K 1-10V z czujnikiem ruchu

5-lat gwarancji	ON OFF 50000	polycarbonate	60-120°	MAX -30 ÷ 45	voltage 100-277V AC	190 lm W	IP 65
DALI option	SMD 2835			aluminum	100000 h L70B50	PF 0,95	640 LED

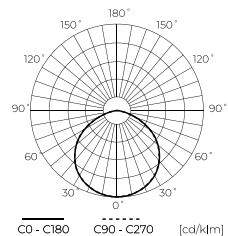
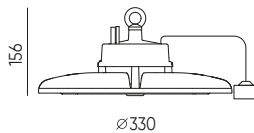

207066

LED line PRIME

SYMBOL	NAZWA	KĄT ŚWIECENIA	MOC	TEMPERATURA BARWOWA	STRUMIEŃ ŚWIETLNY
207066 New	High Bay PHANTOM 190 200W 38000lm 4000K 1-10V z czujnikiem ruchu	120°	200W	4000K	38000lm
207073 New	High Bay PHANTOM 190 200W 38000lm 4000K 1-10V z czujnikiem ruchu	90°	200W	4000K	38000lm
207080 New	High Bay PHANTOM 190 200W 38000lm 4000K 1-10V z czujnikiem ruchu	60°	200W	4000K	38000lm







HIGH BAY
RAIDER

High bay UFO RAIDER 100W 13000lm 4000K



A T G E

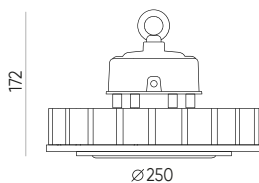

5-lat gwarancji	LED provided by LUMILEDS	120°	250 mm	MAX -40 ÷ 45	voltage 100-277V AC	130lm W	IP 65
SMD 3030	*.IES ↓	aluminum	50000 h L70B50	PF 0,95	144 LED	IK 08	

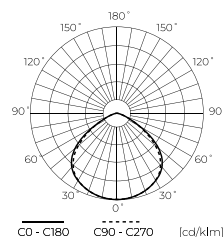

LED line PRIME

SYMBOL	NAZWA	KĄT ŚWIECENIA	MOC	TEMPERATURA BARWOWA	STRUMIEŃ ŚWIETLNY
470935	High bay UFO RAIDER 130 100W 13000lm 4000K	120°	100W	4000K	13000lm

High bay UFO RAIDER 150W 19500lm 4000K



A T G E

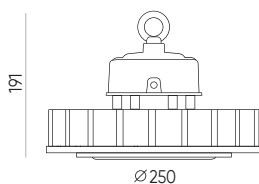

5-lat gwarancji	LED provided by LUMILEDS	120°	250 mm	MAX -40 ÷ 45	voltage 100-277V AC	130lm W	IP 65
SMD 3030	*.IES ↓	aluminum	50000 h L70B50	PF 0,95	200 LED	IK 08	

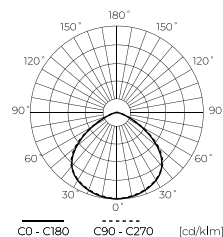

LED line PRIME

SYMBOL	NAZWA	KĄT ŚWIECENIA	MOC	TEMPERATURA BARWOWA	STRUMIEŃ ŚWIETLNY
470966	High bay UFO RAIDER 150W 19500lm 4000K	120°	150W	4000K	19500lm

High bay UFO T-Series 100W 15000lm 4000K 1-10V



A T G D

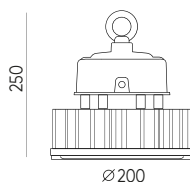

5-lat gwarancji	LED provided by CREE	DIMMABLE	flicker free	1-10V	120°	200 mm	MAX -40 ÷ 45	voltage 100-277V AC	150 lm W	IP 65
SMD 3030	*.IES ↓	MEANWELL DRIVER	polycarbonate	aluminum	50000 h L70B50	PF 0,95	144 LED	IK 08		

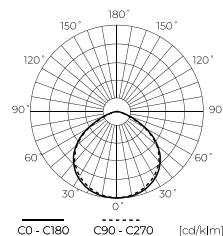

LED line PRIME

SYMBOL	NAZWA	KĄT ŚWIECENIA	MOC	TEMPERATURA BARWOWA	STRUMIEŃ ŚWIETLNY
244339	High bay UFO T-Series 100-277V 100W 15000lm 4000K DIM	120°	100W	4000K	15000lm

najlepsza cena
na rynku



hartowane
szkło

kąt świecenia
110°

moc
100 - 200W

wodoodporność
IP65

HIGH BAY
ECOBEBAM

High bay ECOBEAM 100W 10000lm 4000K

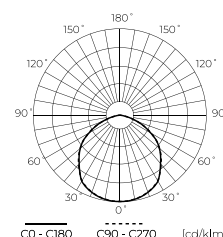
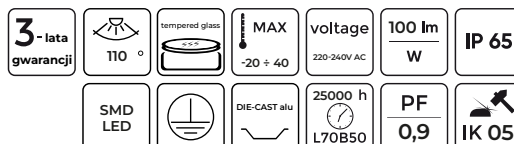

LED line LITE

SYMBOL	NAZWA	KĄT ŚWIECENIA	MOC	TEMPERATURA BARWOWA	STRUMIEŃ ŚWIETLNY
203396	High bay ECOBEAM 100W 10000lm 4000K	110°	100W	4000K	10000lm

High bay ECOBEAM 150W 15000lm 4000K

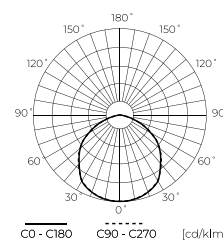
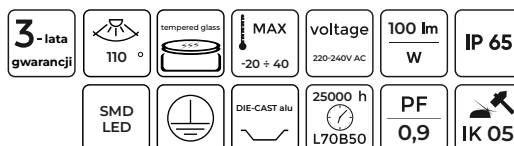
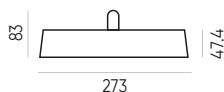

LED line LITE

SYMBOL	NAZWA	KĄT ŚWIECENIA	MOC	TEMPERATURA BARWOWA	STRUMIEŃ ŚWIETLNY
203402	High bay ECOBEAM 150W 15000lm 4000K	110°	150W	4000K	15000lm

High bay ECOBEAM 200W 20000lm 4000K

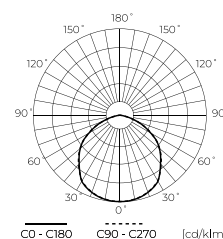
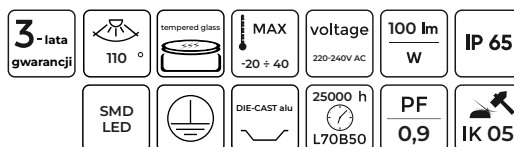
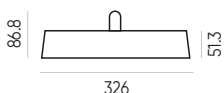

LED line LITE

SYMBOL	NAZWA	KĄT ŚWIECENIA	MOC	TEMPERATURA BARWOWA	STRUMIEŃ ŚWIETLNY
203419	High bay ECOBEAM 200W 20000lm 4000K	110°	200W	4000K	20000lm



HIGH BAY
STREAKBAY



High bay STREAKBAY 50W 5000lm 4000K

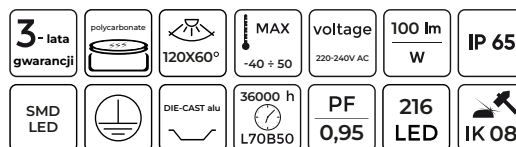
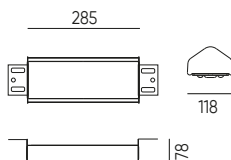

LED line LITE

SYMBOL	NAZWA	KĄT ŚWIECENIA	MOC	TEMPERATURA BARWOWA	STRUMIEŃ ŚWIETLNY
206748 New	High bay STREAKBAY 50W 5000lm 4000K	120x60°	50W	4000K	5000lm

High bay STREAKBAY 100W 10000lm 4000K

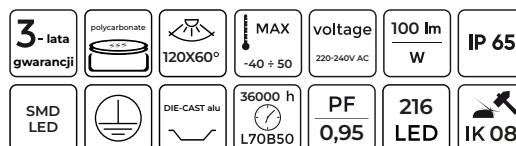
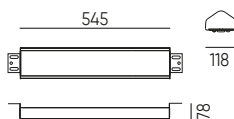

LED line LITE

SYMBOL	NAZWA	KĄT ŚWIECENIA	MOC	TEMPERATURA BARWOWA	STRUMIEŃ ŚWIETLNY
206755 New	High bay STREAKBAY 100W 10000lm 4000K	120x60°	100W	4000K	10000lm

High bay STREAKBAY 150W 15000lm 4000K

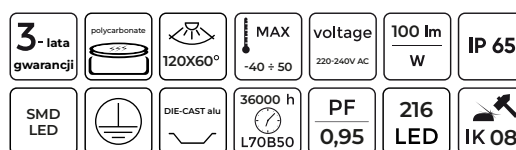
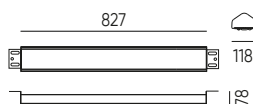

LED line LITE

SYMBOL	NAZWA	KĄT ŚWIECENIA	MOC	TEMPERATURA BARWOWA	STRUMIEŃ ŚWIETLNY
206762 New	High bay STREAKBAY 150W 15000lm 4000K	120x60°	150W	4000K	15000lm

High bay STREAKBAY 200W 20000lm 4000K

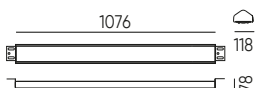

3-lata gwarancji	polycarbonate	120X60°	MAX -40 ÷ 50	voltage 220-240V AC	100 lm W	IP 65
SMD LED		DIE-CAST alu	36000 h L70B50	PF 0,95	216 LED	IK 08



LED line LITE

SYMBOL	NAZWA	KĄT ŚWIECENIA	MOC	TEMPERATURA BARWOWA	STRUMIEŃ ŚWIETLNY
206779 New	High bay STREAKBAY 200W 20000lm 4000K	120x60°	200W	4000K	20000lm

Akcesoria



LED line LITE

SYMBOL	NAZWA
206786 New	Linki stalowe

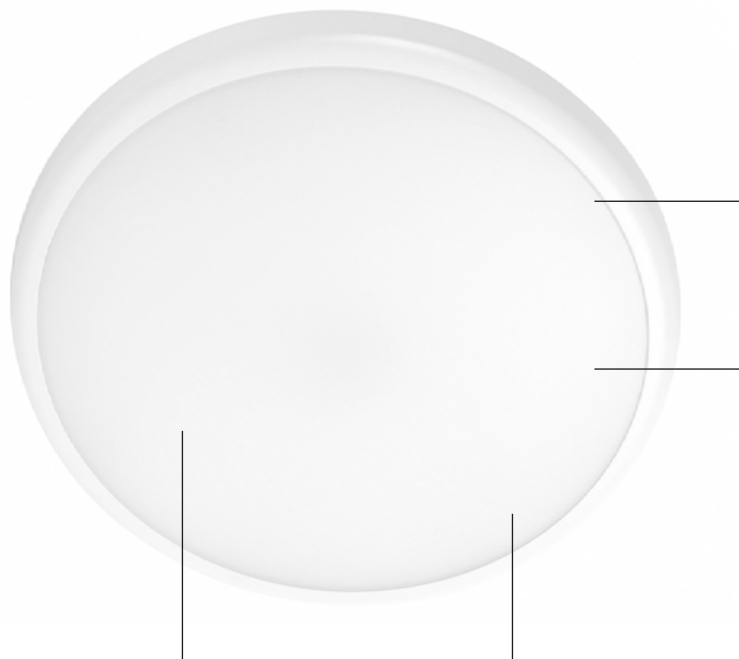

odporny na promieniowanie UV i żółknięcie

wodoodporność IP65

szybki montaż - naciśnij i kliknij

dostępna wersja z czujnikiem ruchu

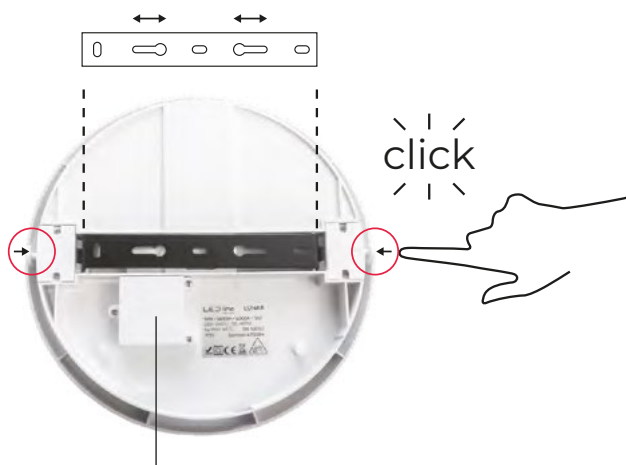

puszka przyłączeniowa

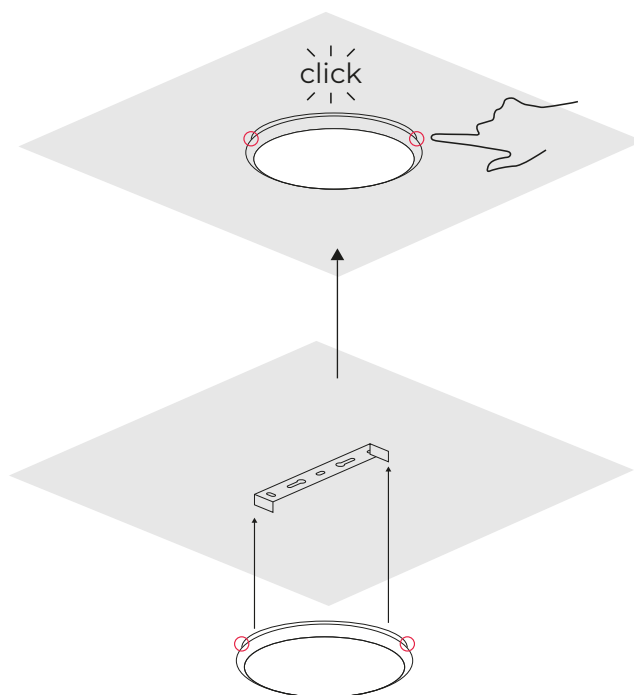

OPRAWA SUFITOWA **LUNAR**

**Plafon LUNAR 16W 1360lm
4000K**

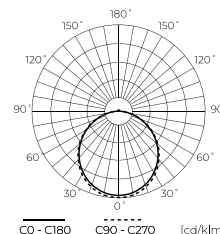
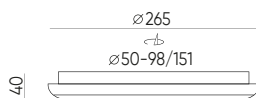
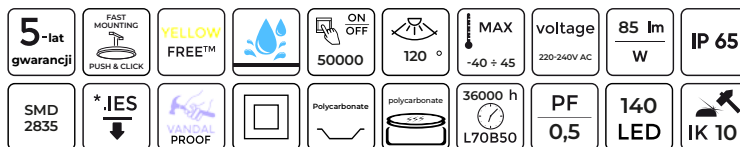

LED line PRIME

SYMBOL	NAZWA	KĄT ŚWIECENIA	MOC	TEMPERATURA BARWOWA	STRUMIEŃ ŚWIETLNY
470577	Plafon LUNAR 16W 1360lm 4000K	120°	16W	4000K	1360lm

**Plafon LUNAR 22W 1870lm
4000K**

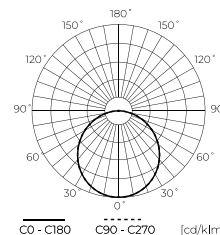
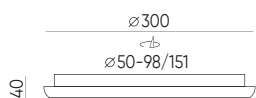
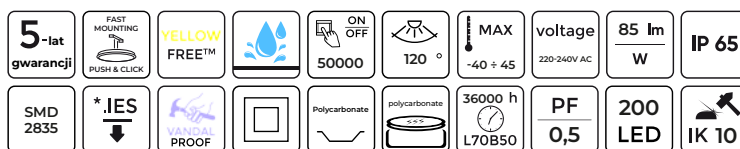

LED line PRIME

SYMBOL	NAZWA	KĄT ŚWIECENIA	MOC	TEMPERATURA BARWOWA	STRUMIEŃ ŚWIETLNY
470591	Plafon LUNAR 22W 1870lm 4000K	120°	22W	4000K	1870lm

**Plafon LUNAR 16W 1360lm
4000K z czujnikiem ruchu**

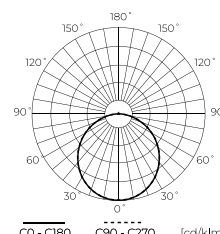
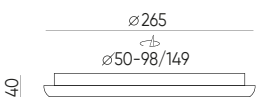
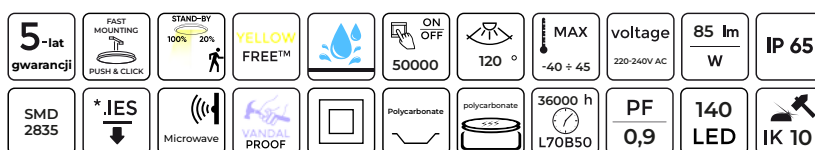

LED line PRIME

SYMBOL	NAZWA	KĄT ŚWIECENIA	MOC	TEMPERATURA BARWOWA	STRUMIEŃ ŚWIETLNY
470584	Plafon LUNAR 16W 1360lm 4000K z czujnikiem ruchu	120°	16W	4000K	1360lm

Plafon LUNAR 22W 1870lm 4000K z czujnikiem ruchu

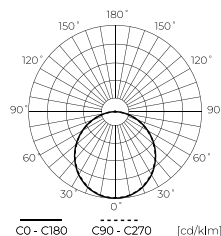
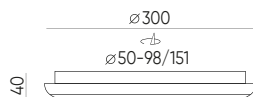
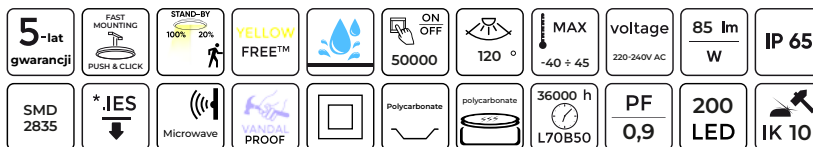

LED line PRIME

SYMBOL	NAZWA	KĄT ŚWIECENIA	MOC	TEMPERATURA BARWOWA	STRUMIEŃ ŚWIETLNY
470607	Plafon LUNAR 22W 1870lm 4000K z czujnikiem ruchu	120°	22W	4000K	1870lm

Plafon LUNAR 16W 1600lm 4000K IP65

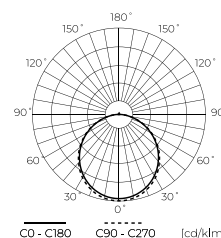
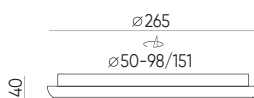
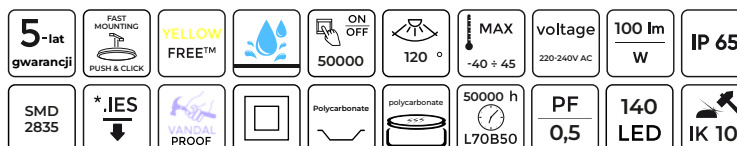

LED line PRIME

SYMBOL	NAZWA	KĄT ŚWIECENIA	MOC	TEMPERATURA BARWOWA	STRUMIEŃ ŚWIETLNY
470577-II	Plafon LUNAR 16W 1600lm 4000K IP65	120°	16W	4000K	1600lm

Plafon LUNAR 22W 2200lm 4000K IP65

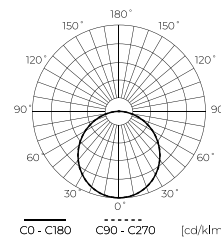
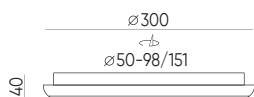
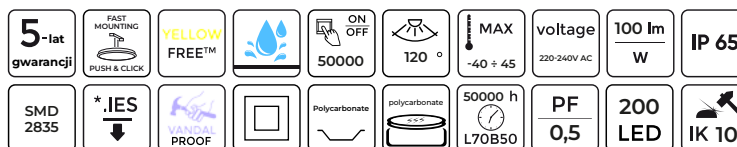

LED line PRIME

SYMBOL	NAZWA	KĄT ŚWIECENIA	MOC	TEMPERATURA BARWOWA	STRUMIEŃ ŚWIETLNY
470591-II	Plafon LUNAR 22W 2200lm 4000K IP65	120°	22W	4000K	2200lm

Plafon LUNAR 16W 1600lm 4000K IP65 z czujnikiem ruchu

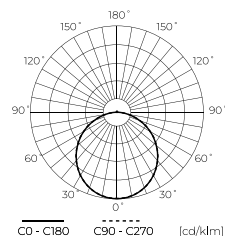
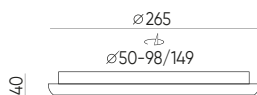
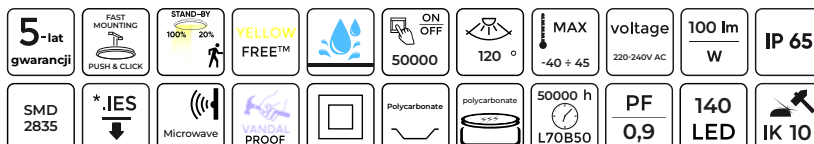

LED line PRIME

SYMBOL	NAZWA	KĄT ŚWIECENIA	MOC	TEMPERATURA BARWOWA	STRUMIEŃ ŚWIETLNY
470584-II	Plafon LUNAR 16W 1600lm 4000K IP65 z czujnikiem ruchu	120°	16W	4000K	1600lm

Plafon LUNAR 22W 2200lm 4000K IP65 z czujnikiem ruchu

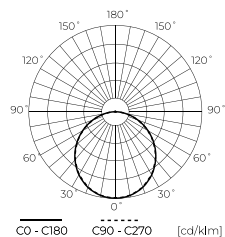
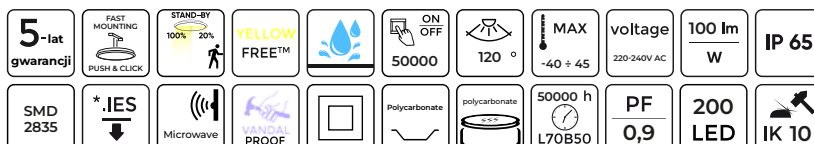

LED line PRIME

SYMBOL	NAZWA	KĄT ŚWIECENIA	MOC	TEMPERATURA BARWOWA	STRUMIEŃ ŚWIETLNY
470607-II	Plafon LUNAR 22W 2200lm 4000K IP65 z czujnikiem ruchu	120°	22W	4000K	2200lm

czujnik mikrofalowy
360°, 8m

na zewnątrz
i do pomieszczeń

wodoodporność
IP54

wersje
3000K, 4000K

linka zabezpieczająca

click

zatrzaski „click”

OPRAWA SUFITOWA
ACTON

Plafon ACTON IP54 okrągła



LED line PRIME

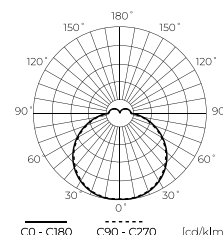
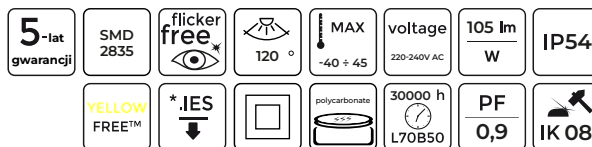

CO - C180 C90 - C270 [cd/klm]

201095

201095

SYMBOL	NAZWA	KĄT ŚWIECENIA	MOC	TEMPERATURA BARWOWA	STRUMIEŃ ŚWIETLNY
201095	Plafon ACTON 18W 1900lm 3000K IP54 okrągła	120°	18W	3000K	1900lm
201101	Plafon ACTON 18W 1900lm 3000K IP54 okrągła z czujnikiem ruchu	120°	18W	3000K	1900lm
201118	Plafon ACTON 18W 2000lm 4000K IP54 okrągła	120°	18W	4000K	2000lm
201125	Plafon ACTON 18W 2000lm 4000K IP54 okrągła z czujnikiem ruchu	120°	18W	4000K	2000lm
201132	Plafon ACTON 24W 2600lm 4000K IP54 okrągła	120°	24W	4000K	2600lm
201149	Plafon ACTON 24W 2600lm 4000K IP54 okrągła z czujnikiem ruchu	120°	24W	4000K	2600lm

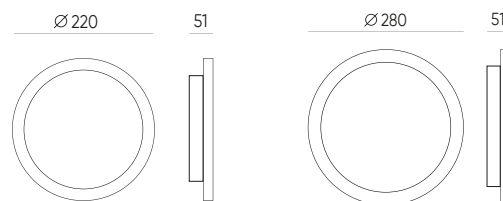

201095
201101
201118
201125

201132
201149

Plafon ACTON IP54 kwadratowa



LED line PRIME

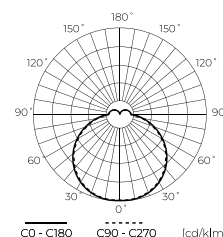
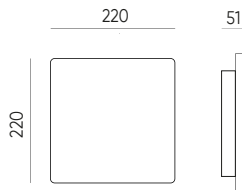
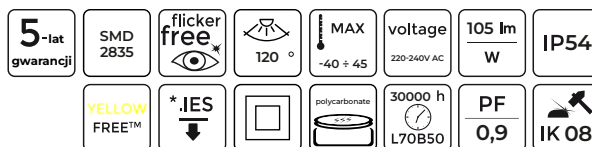

201156

201156

SYMBOL	NAZWA	KĄT ŚWIECENIA	MOC	TEMPERATURA BARWOWA	STRUMIEŃ ŚWIETLNY
201156	Plafon ACTON 18W 1900lm 3000K IP54 kwadratowa	120°	18W	3000K	1900lm
201163	Plafon ACTON 18W 1900lm 3000K IP54 kwadratowa z czujnikiem ruchu	120°	18W	3000K	1900lm
201170	Plafon ACTON 18W 2000lm 4000K IP54 kwadratowa	120°	18W	4000K	2000lm
201187	Plafon ACTON 18W 2000lm 4000K IP54 kwadratowa z czujnikiem ruchu	120°	18W	4000K	2000lm

dostępna w trzech typach
mocy 12W, 18W i 24W

czujnik mikrofalowy
360°, 8m



CRI>80

bez efektu
migotania

okrągły kształt
o średnicach Ø260mm,
Ø350mm i Ø380mm

OPRAWA SUFITOWA

PLAFON IP44

PLAFON IP44 12W 900lm 3000K

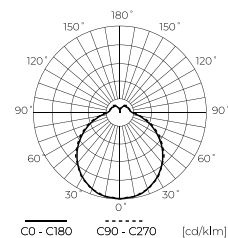
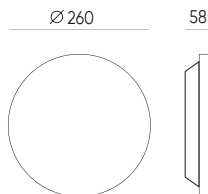
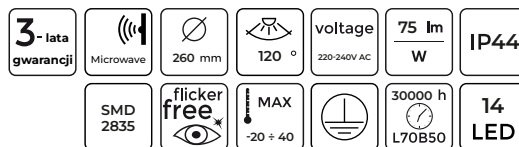

201354

201354

LED line LITE

SYMBOL	NAZWA	KĄT ŚWIECENIA	MOC	TEMPERATURA BARWOWA	STRUMIEŃ ŚWIETLNY
201354	PLAFON IP44 12W 900lm 3000K	120°	12W	3000K	900lm
201361	PLAFON IP44 12W 900lm 3000K z czujnikiem ruchu	120°	12W	3000K	900lm

PLAFON IP44 12W 960lm 4000K

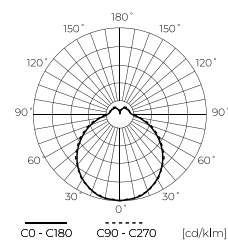
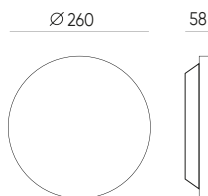
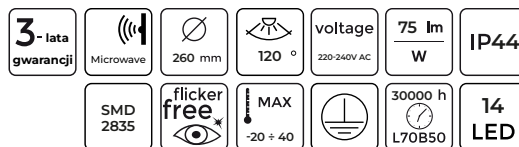

201378

201378

LED line LITE

SYMBOL	NAZWA	KĄT ŚWIECENIA	MOC	TEMPERATURA BARWOWA	STRUMIEŃ ŚWIETLNY
201378	PLAFON IP44 12W 960lm 4000K	120°	12W	4000K	960lm
201385	PLAFON IP44 12W 960lm 4000K z czujnikiem ruchu	120°	12W	4000K	960lm

PLAFON IP44 18W 1450lm 3000K

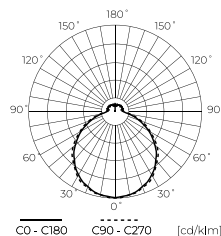
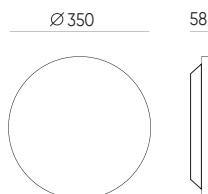
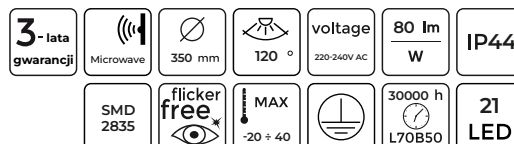

201392

201392

LED line LITE

SYMBOL	NAZWA	KĄT ŚWIECENIA	MOC	TEMPERATURA BARWOWA	STRUMIEŃ ŚWIETLNY
201392	PLAFON IP44 18W 1450lm 3000K	120°	18W	3000K	1450lm
201408	PLAFON IP44 18W 1450lm 3000K z czujnikiem ruchu	120°	18W	3000K	1450lm

PLAFON IP44 18W 1550lm 4000K

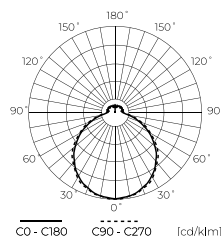
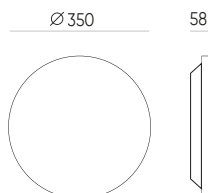
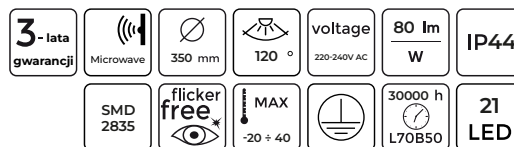

201415

201415

LED line LITE

SYMBOL	NAZWA	KĄT ŚWIECENIA	TEMPERATURA BARWOWA	TEMPERATURA BARWOWA	STRUMIEŃ ŚWIETLNY
201415	PLAFON IP44 18W 1550lm 4000K	120°	18W	4000K	1550lm
201422	PLAFON IP44 18W 1550lm 4000K z czujnikiem ruchu	120°	18W	4000K	1550lm

PLAFON IP44 24W 1950lm 4000K

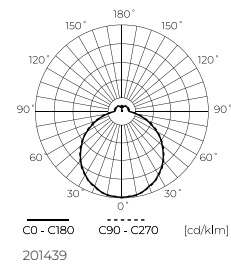
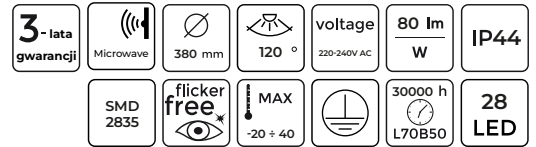
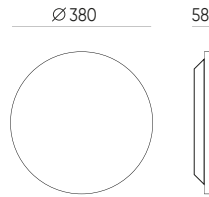

201439

LED line LITE

SYMBOL	NAZWA	KĄT ŚWIECENIA	MOC	TEMPERATURA BARWOWA	STRUMIEŃ ŚWIETLNY
201439	PLAFON IP44 24W 1950lm 4000K	120°	24W	4000K	1950lm
201446	PLAFON IP44 24W 1950lm 4000K z czujnikiem ruchu	120°	24W	4000K	1950lm

Plafon BULKHEAD 12W 840lm 4000K

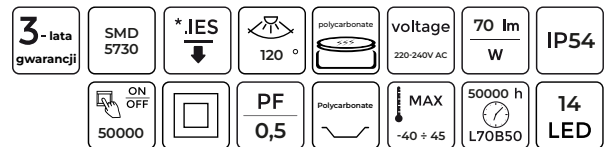
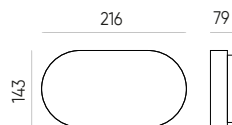

LED line LITE

SYMBOL	NAZWA	KĄT ŚWIECENIA	MOC	TEMPERATURA BARWOWA	STRUMIEŃ ŚWIETLNY
245497	Plafon BULKHEAD 12W 840lm 4000K	120°	12W	4000K	840lm







łączenie przelotowe

TRI-PROOF
RANGER



Tri-proof RANGER C lamp 40W 5600lm 4000K IP66

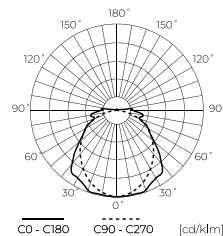
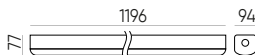
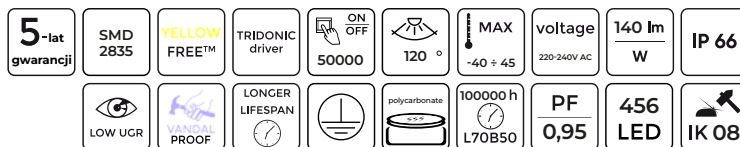

LED line PRIME

SYMBOL	NAZWA	KĄT ŚWIECENIA	MOC	TEMPERATURA BARWOWA	STRUMIEŃ ŚWIETLNY
471109	Tri-proof RANGER C lamp 40W 5600lm 4000K IP66	120°	40W	4000K	5600lm

Tri-proof RANGER C 40W 6800lm 4000K 1-10V

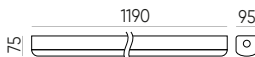

LED line PRIME

SYMBOL	NAZWA	KĄT ŚWIECENIA	MOC	TEMPERATURA BARWOWA	STRUMIEŃ ŚWIETLNY
201262	Tri-proof RANGER C 40W 6800lm 4000K 1-10V	120°	40W	4000K	6800lm



wydajność
150lm/W

L70B50
100.000h

wodoodporność
IP65

TRI-PROOF
LINKER

wersja czarna



klosz
z poliwęglanu IK08

wiele wariantów 21-80W,
4000-5000K

łączenie przelotowe



Tri-proof LINKER 21W 3150lm 4000K IP65

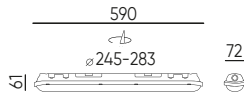
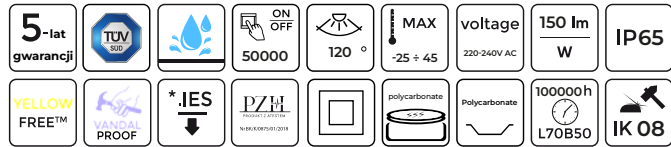

LED line PRIME

SYMBOL	NAZWA	KĄT ŚWIECENIA	MOC	TEMPERATURA BARWOWA	STRUMIEŃ ŚWIETLNY
479587	Tri-proof LINKER 21W 3150lm 4000K 150lm/W 220-240V IP65	120°	21W	4000K	3150lm

Tri-proof LINKER 30W 4500lm 4000K IP65

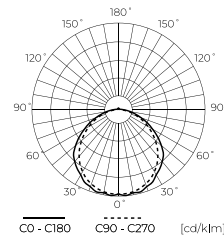
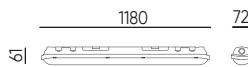
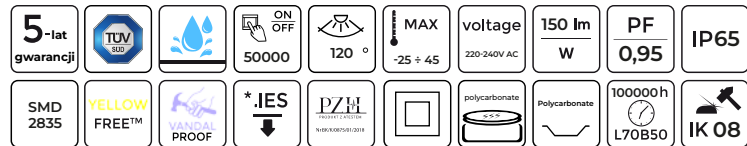

LED line PRIME

SYMBOL	NAZWA	KĄT ŚWIECENIA	MOC	TEMPERATURA BARWOWA	STRUMIEŃ ŚWIETLNY
203709	Tri-proof LINKER 30W 4500lm 4000K 150lm/W 220-240V IP65	120°	30W	4000K	4500lm

Tri-proof LINKER 40W 6000lm 4000K IP65

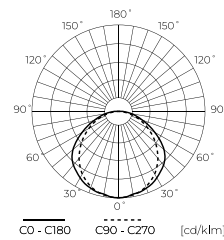
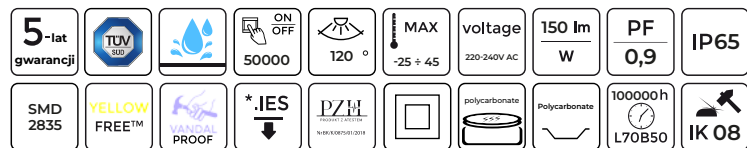

LED line PRIME

SYMBOL	NAZWA	KĄT ŚWIECENIA	MOC	TEMPERATURA BARWOWA	STRUMIEŃ ŚWIETLNY
479594	Tri-proof LINKER 40W 6000lm 4000K 150lm/W 220-240V IP65	120°	40W	4000K	6000lm

**Tri-proof LINKER 40W 6000lm
5000K IP65**

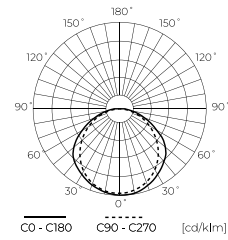

LED line PRIME

SYMBOL	NAZWA	KĄT ŚWIECENIA	MOC	TEMPERATURA BARWOWA	STRUMIEŃ ŚWIETLNY
201279	Tri-proof LINKER 40W 6000lm 5000K 150lm/W IP65	120°	40W	5000K	6000lm

**Tri-proof LINKER 40W 6000lm
4000K IP65**

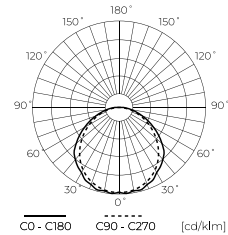
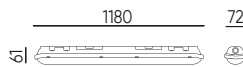
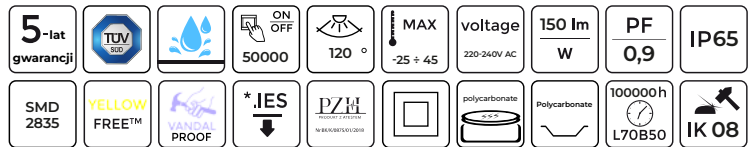

LED line PRIME

SYMBOL	NAZWA	KĄT ŚWIECENIA	MOC	TEMPERATURA BARWOWA	STRUMIEŃ ŚWIETLNY
203754	Tri-proof LINKER 40W 6000lm 4000K 150lm/W IP65	120°	40W	4000K	6000lm

**Tri-proof LINKER 80W 12000lm
4000K IP65**

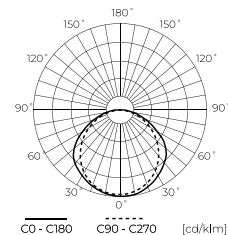
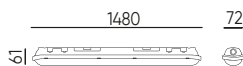

LED line PRIME

SYMBOL	NAZWA	KĄT ŚWIECENIA	MOC	TEMPERATURA BARWOWA	STRUMIEŃ ŚWIETLNY
201057	Tri-proof LINKER 80W 12000lm 4000K 150lm/W IP65	120°	80W	4000K	12000lm



TRI-PROOF
TRI-PROOF

TRI-PROOF 4000K IP65 z czujnikiem ruchu

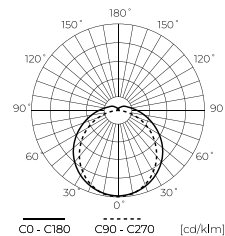
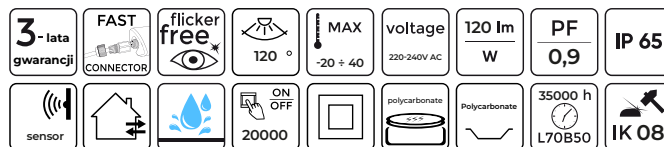

LED line LITE

SYMBOL	NAZWA	KĄT ŚWIECENIA	MOC	TEMPERATURA BARWOWA	STRUMIEŃ ŚWIETLNY
477606	TRI-PROOF 30W 4000K 3600lm 650mm	120°	30W	4000K	3600lm
477644	TRI-PROOF 30W 4000K 3600lm 650mm z czujnikiem ruchu	120°	30W	4000K	3600lm
477613	TRI-PROOF 40W 4000K 4800lm 1250mm	120°	40W	4000K	4800lm
477651	TRI-PROOF 40W 4000K 4800lm 1250mm z czujnikiem ruchu	120°	40W	4000K	4800lm
477620	TRI-PROOF 70W 4000K 8400lm 1550mm	120°	70W	4000K	8400lm
477637	TRI-PROOF 90W 4000K 10800lm 1550mm	120°	90W	4000K	10800lm

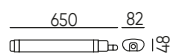

477606
477644

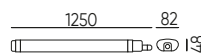

477613
477651

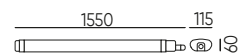

477620
477637

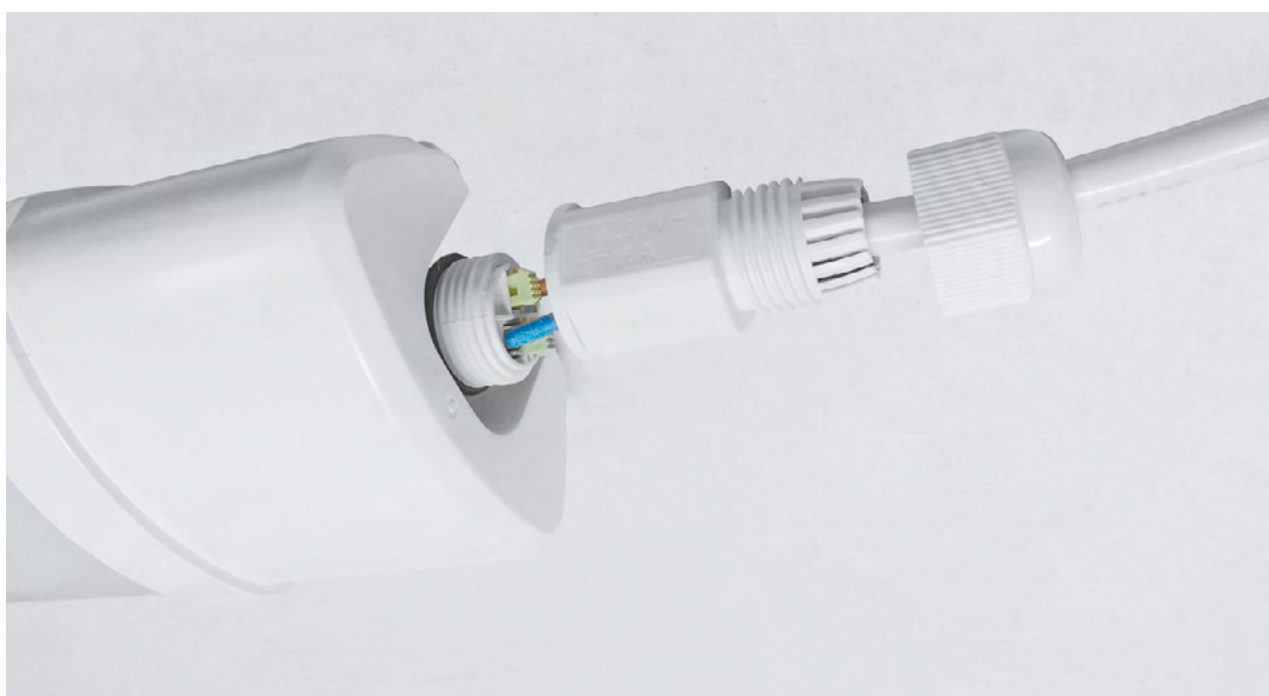



wydajność
150lm/W

minimalistyczny
design

wodoodporność
IP66

OPRAWA PARKOWA
NOLINA

Oprawa parkowa NOLINA

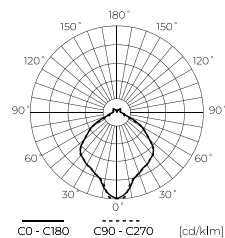
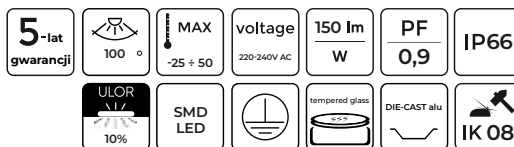
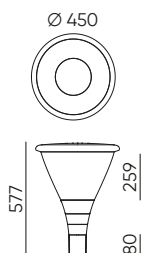

207127

LED line PRIME

SYMBOL	NAZWA	KĄT ŚWIECENIA	MOC	TEMPERATURA BARWOWA	STRUMIEŃ ŚWIETLNY
207127 New	Oprawa parkowa NOLINA 30W 4000K 4500lm	100°	30W	4000K	4500lm
207134 New	Oprawa parkowa NOLINA 60W 4000K 9000lm	100°	60W	4000K	9000lm

minimalistyczny
design

wydajność
120lm/W

wodoodporność
IP65

dostępna w dwóch
kolorach:

● czarny

● szary

OPRAWA PARKOWA
PARKLITE

Oprawa parkowa PARKLITE

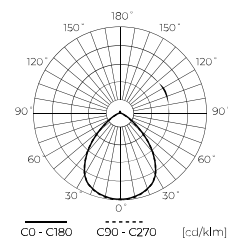
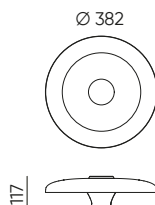
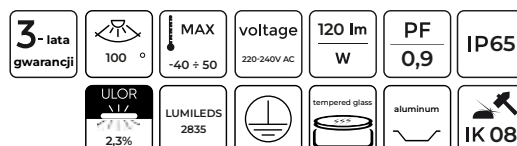

207462



LED line LITE

SYMBOL	NAZWA	KĄT ŚWIECENIA	MOC	TEMPERATURA BARWOWA	STRUMIEŃ ŚWIETLNY
207462 New	Oprawa parkowa PARKLITE 50-80-100W CCT 6000-12000lm 4000K czarna	100°	50-80-100W	4000K	6000-12000lm
209824 New	Oprawa parkowa PARKLITE 50-80-100W CCT 6000-12000lm 4000K szara	100°	50-80-100W	4000K	6000-12000lm
207479 New	Oprawa parkowa PARKLITE 80-100-120W CCT 9600-14400lm 3000-4000-6500K czarna	100°	80-100-120W	3000-4000-6500K	9600-14400lm
209831 New	Oprawa parkowa PARKLITE 80-100-120W CCT 9600-14400 lm 3000-4000-6500K szara	100°	80-100-120W	3000-4000-6500K	9600-14400lm
207486 New	Oprawa parkowa PARKLITE 50W CCT 6000lm 3000-4000-6500K czarna	100°	50W	3000-4000-6500K	6000lm
209848 New	Oprawa parkowa PARKLITE 50W CCT 6000lm 3000-4000-6500K czarna	100°	50W	3000-4000-6500K	6000lm

wydajność
120lm/W

L70B50
50.000h



obudowa z odlewu
aluminium i śruby
ze stali nierdzewnej

solidny
klosz

montaż
na szczycie słupa
(redukcja 60mm)

OPRAWA DROGOWA **ELIDA**

Oprawa drogowa ELIDA IP65



5-let gwarancji	SMD LED 2835	Asymmetrical T3	MAX -40 ÷ 50	voltage 100-277V	120 lm W	PF 0,95	IP 65
ULOR 0%		tempered glass	aluminum	64 LED	50000 h L70B50		IK 08

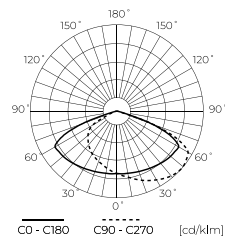

475473

475473

LED line PRIME

SYMBOL	NAZWA	KĄT ŚWIECENIA	MOC	TEMPERATURA BARWOWA	STRUMIEŃ ŚWIETLNY
475473	Oprawa drogowa ELIDA 40W 4800lm 4000K 120lm/W 100-277V AC T3	120°	40W	4000K	4800lm
478498	Oprawa drogowa ELIDA 70W 8400lm 4000K 120lm/W 100-277V AC T3	120°	70W	4000K	8400lm

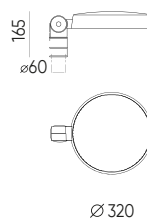

475473

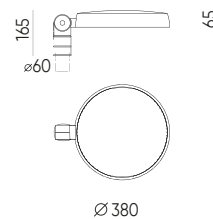

478498

L70B50 -
100.000h

zabezpieczenie
przepięciowe 10kV

ZHAGA
opcjonalnie

możliwość uchylenia
oprawy +/-15°

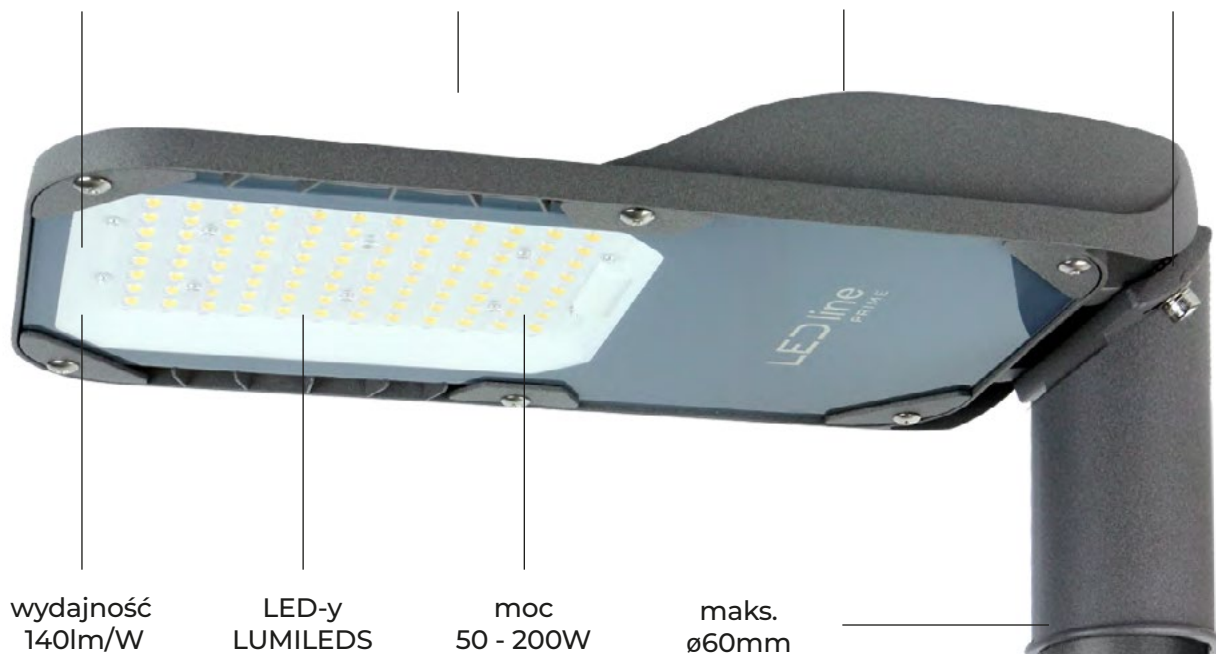

wydajność
140lm/W

LED-y
LUMILEDS

moc
50 - 200W

maks.
ø60mm

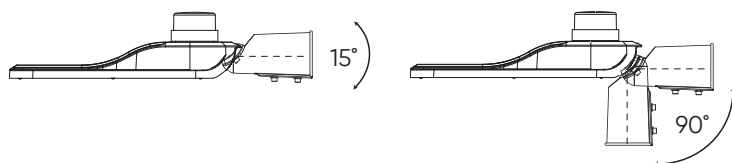

OPRAWA DROGOWA
CAMINO

Oprawa drogowa CAMINO IP66



5-lata gwarancji	150x110°	MAX -40 ÷ 50	voltage 220-240V AC	140 lm W	PF 0,9	IP 66
LUMILEDS 2835	ULOR 0%		tempered glass	aluminum	100000h L70B50	IK 08

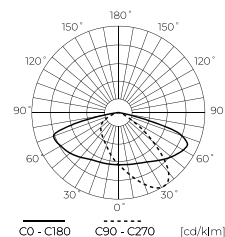

203105

203105

LED line PRIME

SYMBOL	NAZWA	KĄT ŚWIECENIA	MOC	TEMPERATURA BARWOWA	STRUMIEŃ ŚWIETLNY
203105	Oprawa drogowa CAMINO 50W 7000lm 4000K	150 x 110°	50W	4000K	7000lm
206564 New	Oprawa drogowa CAMINO 50W 6500lm 3000K	150 x 110°	50W	3000K	6500lm
203112	Oprawa drogowa CAMINO 100W 14000lm 4000K	150 x 110°	100W	4000K	14000lm
206571 New	Oprawa drogowa CAMINO 100W 13000lm 3000K	150 x 110°	100W	3000K	13000lm
203129	Oprawa drogowa CAMINO 150W 21000lm 4000K	150 x 110°	150W	4000K	21000lm
203136	Oprawa drogowa CAMINO 200W 28000lm 4000K	150 x 110°	200W	4000K	28000lm

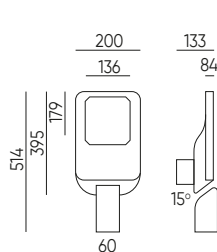

203105
206564

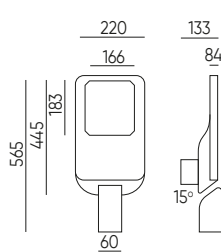

203112
206571

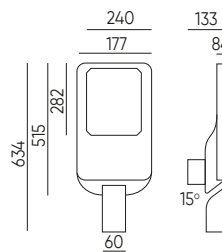

203129

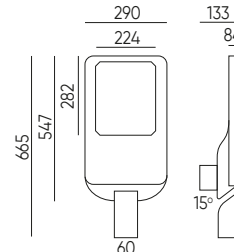

203136

Oprawa drogowa FLAMINGO szara

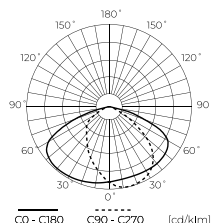
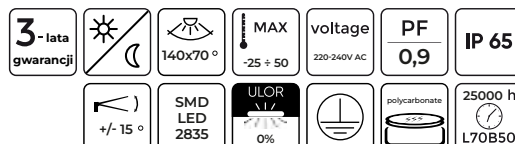

LED line LITE

203785

203785

SYMBOL	NAZWA	KĄT ŚWIECENIA	MOC	TEMPERATURA BARWOWA	STRUMIEŃ ŚWIETLNY
203785	Oprawa drogowa FLAMINGO 30W 3000lm 4000K szara	140 x 70°	30W	4000K	3000lm
206960 New	Oprawa drogowa FLAMINGO 30W 3000lm 4000K z czujnikiem zmierzchu szara	140 x 70°	30W	4000K	3000lm
203792	Oprawa drogowa FLAMINGO 50W 5000lm 4000K szara	140 x 70°	50W	4000K	5000lm
206977 New	Oprawa drogowa FLAMINGO 50W 5000lm 4000K z czujnikiem zmierzchu szara	140 x 70°	50W	4000K	5000lm
203808	Oprawa drogowa FLAMINGO 100W 10000lm 4000K szara	140 x 70°	100W	4000K	10000lm
206984 New	Oprawa drogowa FLAMINGO 100W 10000lm 4000K z czujnikiem zmierzchu szara	140 x 70°	100W	4000K	10000lm

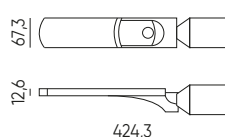

203785
203815
206960

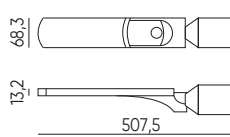

203792
203822
206977

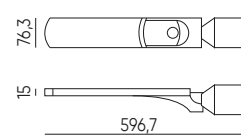

203839
203808
206984

Oprawa drogowa FLAMINGO czarna

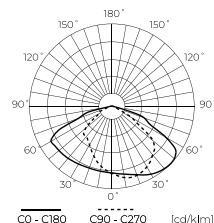
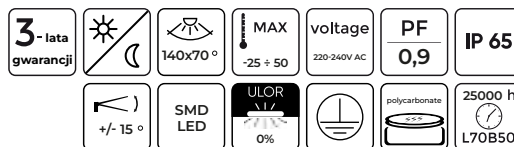

LED line LITE

203815

203815

SYMBOL	NAZWA	KĄT ŚWIECENIA	MOC	TEMPERATURA BARWOWA	STRUMIEŃ ŚWIETLNY
203815	Oprawa drogowa FLAMINGO 30W 3000lm 4000K czarna	140 x 70°	30W	4000K	3000lm
203822	Oprawa drogowa FLAMINGO 50W 5000lm 4000K czarna	140 x 70°	50W	4000K	5000lm
203839	Oprawa drogowa FLAMINGO 100W 10000lm 4000K czarna	140 x 70°	100W	4000K	10000lm

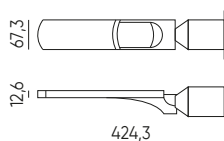

203815

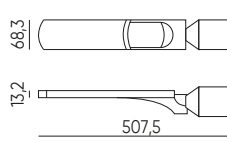

203822

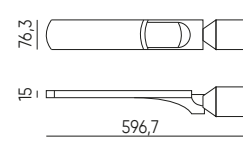

203839



OPRAWA DROGOWA
STREETLITE

Oprawa drogowa STREETLITE szara



3-lata gwarancji	SMD LED 2835	130x75°	MAX -40 ÷ 50°C	voltage 220-240V AC	100 lm W	IP 65
ULOR 0%				PF 0,9	36000 h L70B50	

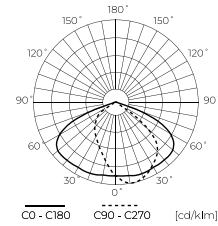

LED line LITE

SYMBOL	NAZWA	KĄT ŚWIECENIA	MOC	TEMPERATURA BARWOWA	STRUMIEŃ ŚWIETLNY
201064	Oprawa drogowa STREETLITE 50W 5000lm 4000K szara	130 x 75°	50W	4000K	5000lm
201071	Oprawa drogowa STREETLITE 100W 10000lm 4000K szara	130 x 75°	100W	4000K	10000lm
201088	Oprawa drogowa STREETLITE 150W 15000lm 4000K szara	130 x 75°	150W	4000K	15000lm

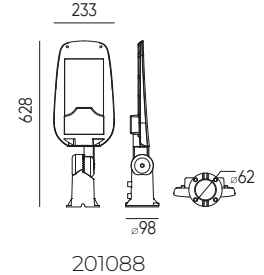
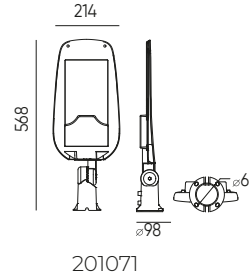
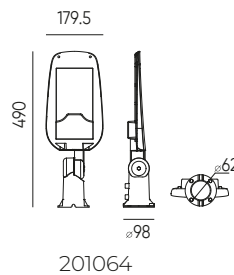

Oprawa drogowa STREETLITE czarna



3-lata gwarancji	SMD LED 2835	130x75°	MAX -40 ÷ 50°C	voltage 220-240V AC	100 lm W	IP 65
ULOR 0%				PF 0,9	36000 h L70B50	

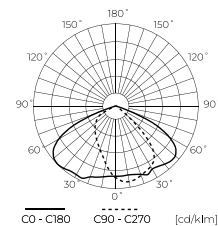

LED line LITE

SYMBOL	NAZWA	KĄT ŚWIECENIA	MOC	TEMPERATURA BARWOWA	STRUMIEŃ ŚWIETLNY
203716	Oprawa drogowa STREETLITE 50W 5000lm 4000K czarna	130 x 75°	50W	4000K	5000lm
203723	Oprawa drogowa STREETLITE 100W 10000lm 4000K czarna	130 x 75°	100W	4000K	10000lm

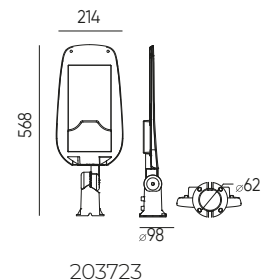
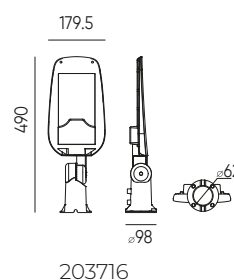

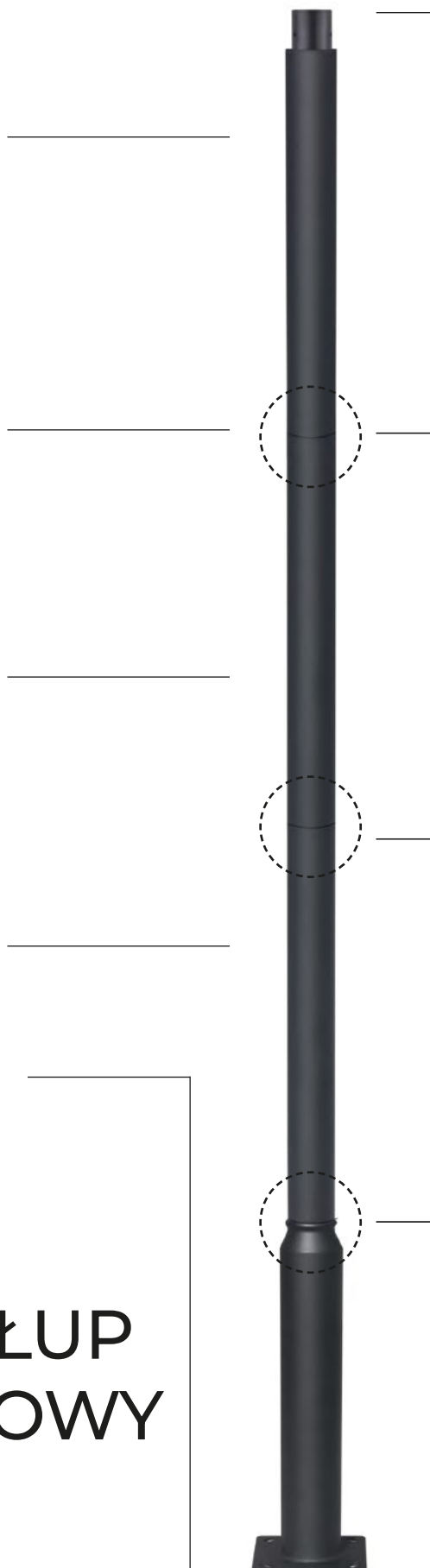

C

B

B

A

dolny słup

OPRAWA DROGOWA
**SKŁADANY SŁUP
OŚWIETLENIOWY**



SKŁADANY SŁUP OŚWIETLENIOWY

SYMBOL	NAZWA	TYP INSTALACJI	MATERIAŁ	GRUBOŚĆ
206618 New	SKŁADANY SŁUP OŚWIETLENIOWY	dzielony	stal ocynkowana Q235	1,5mm



INSTALACJA

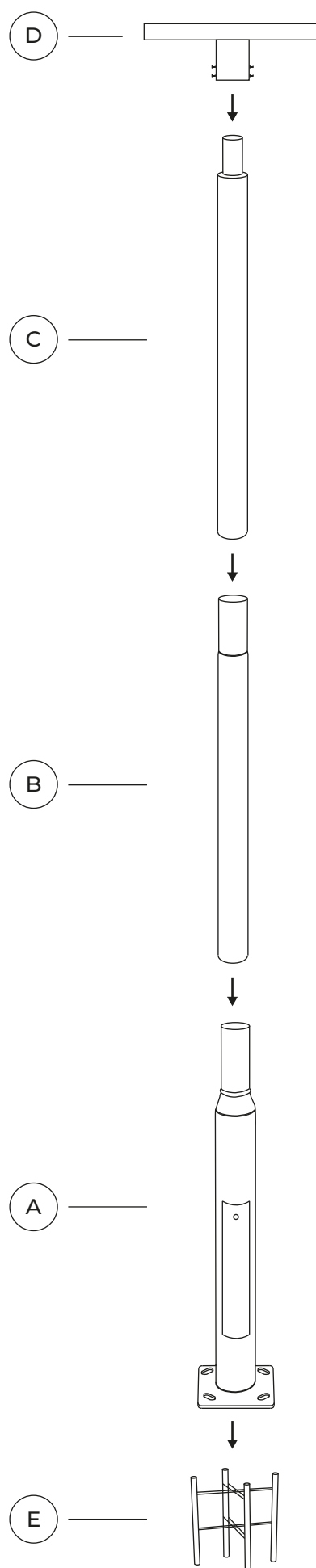
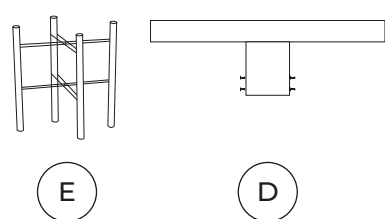
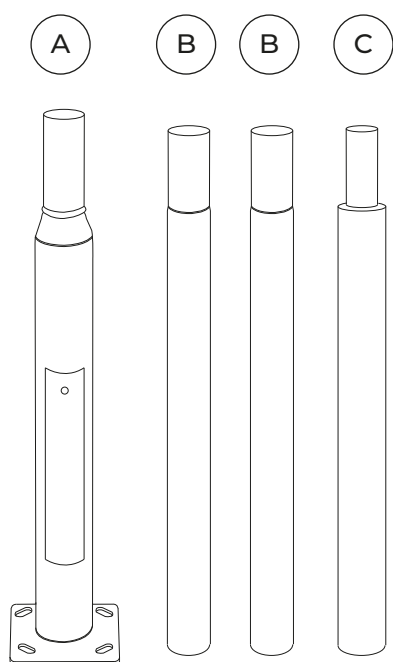



AKCESORIA

Wspornik naświetlacza

SYMBOL	NAZWA	GRUBOŚĆ
206632 New	Wspornik naświetlacza	1,5mm



Łatwy montaż za pomocą gwintowanych otworów (śruba w zestawie)

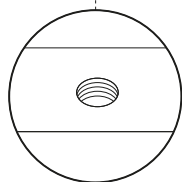

(D)

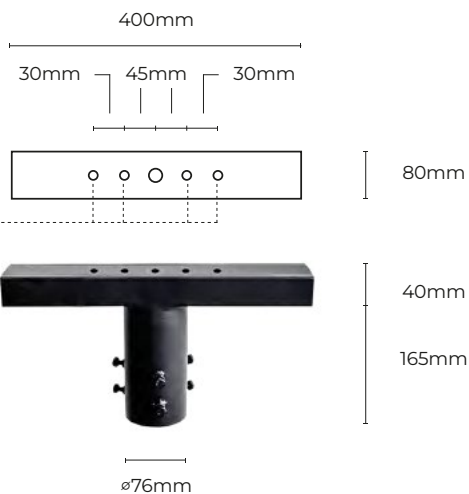

Przedłużenie słupa 1m

SYMBOL	NAZWA	GRUBOŚĆ
206625 New	Przedłużenie słupa 1m	1,5mm



(B)



Rama stalowa 180mm

SYMBOL	NAZWA	GRUBOŚĆ
206649 New	Rama stalowa 180 mm	1,5mm



(E)

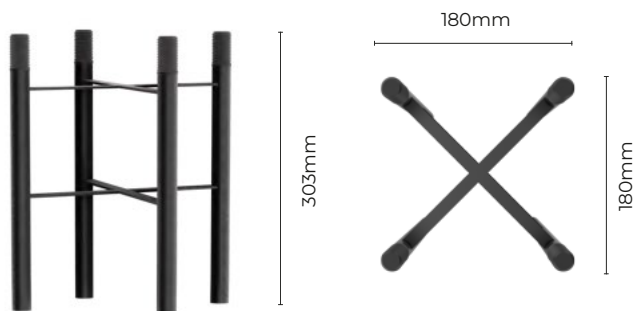

FLOODLIGHT PRIME

regulacja kąta co 15°

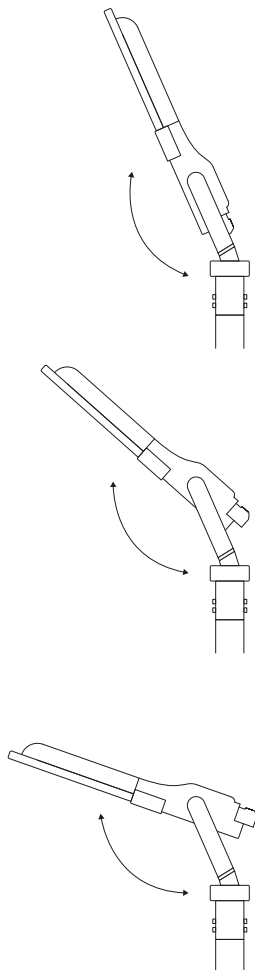

D wspornik
naświetlacza

C górny słup





KINKIET ZEWNĘTRZNY

CUBE CILINDER

**Kinkiet zewnętrzny CUBE
2x3W IP54**

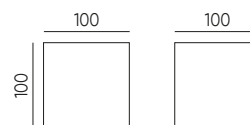
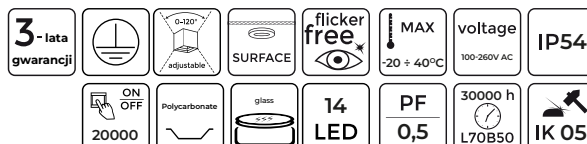

478146

LED line LITE

SYMBOL	NAZWA	KĄT ŚWIECENIA	MOC	TEMPERATURA BARWOWA	STRUMIEŃ ŚWIETLNY
478146	Kinkiet zewnętrzny CUBE 2x3W 450lm 3000K czarny	0 ÷ 120 °	2x3W	3000K	450lm
478153	Kinkiet zewnętrzny CUBE 2x3W 450lm 3000K biały	0 ÷ 120 °	2x3W	3000K	450lm
478160	Kinkiet zewnętrzny CUBE 2x3W 450lm 3000K szary	0 ÷ 120 °	2x3W	3000K	450lm
478177	Kinkiet zewnętrzny CUBE 2x3W 450lm 4000K czarny	0 ÷ 120 °	2x3W	4000K	450lm
478184	Kinkiet zewnętrzny CUBE 2x3W 450lm 4000K biały	0 ÷ 120 °	2x3W	4000K	450lm
478191	Kinkiet zewnętrzny CUBE 2x3W 450lm 4000K szary	0 ÷ 120 °	2x3W	4000K	450lm

**Kinkiet zewnętrzny CILINDER
2x3W IP54**

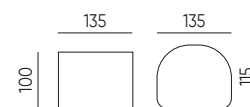
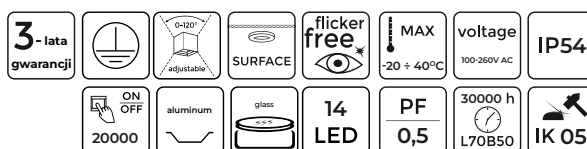

475510

LED line LITE

SYMBOL	NAZWA	KĄT ŚWIECENIA	MOC	TEMPERATURA BARWOWA	STRUMIEŃ ŚWIETLNY
475510	Kinkiet zewnętrzny CILINDER 2x3W 450lm 3000K czarny	0 ÷ 120 °	2x3W	3000K	450lm
475527	Kinkiet zewnętrzny CILINDER 2x3W 450lm 3000K biały	0 ÷ 120 °	2x3W	3000K	450lm
475534	Kinkiet zewnętrzny CILINDER 2x3W 450lm 3000K szary	0 ÷ 120 °	2x3W	3000K	450lm
475541	Kinkiet zewnętrzny CILINDER 2x3W 450lm 4000K czarny	0 ÷ 120 °	2x3W	4000K	450lm
475558	Kinkiet zewnętrzny CILINDER 2x3W 450lm 4000K biały	0 ÷ 120 °	2x3W	4000K	450lm
475565	Kinkiet zewnętrzny CILINDER 2x3W 450lm 4000K szary	0 ÷ 120 °	2x3W	4000K	450lm

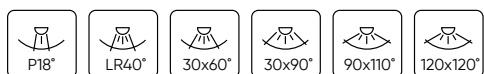

OPRAWA LINIOWA
FUSION



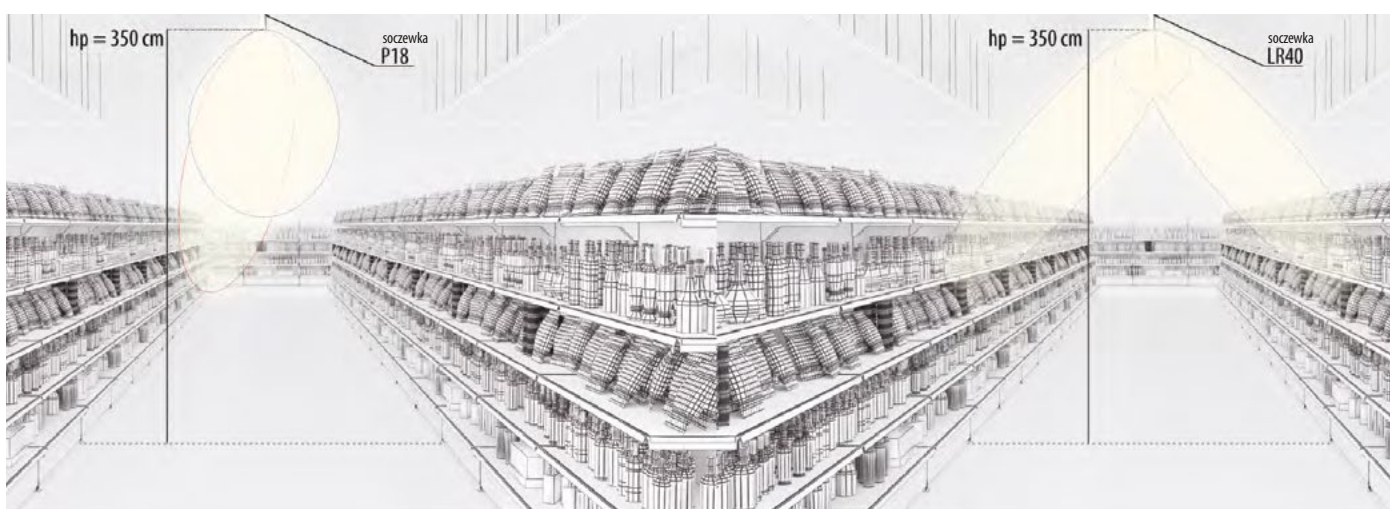
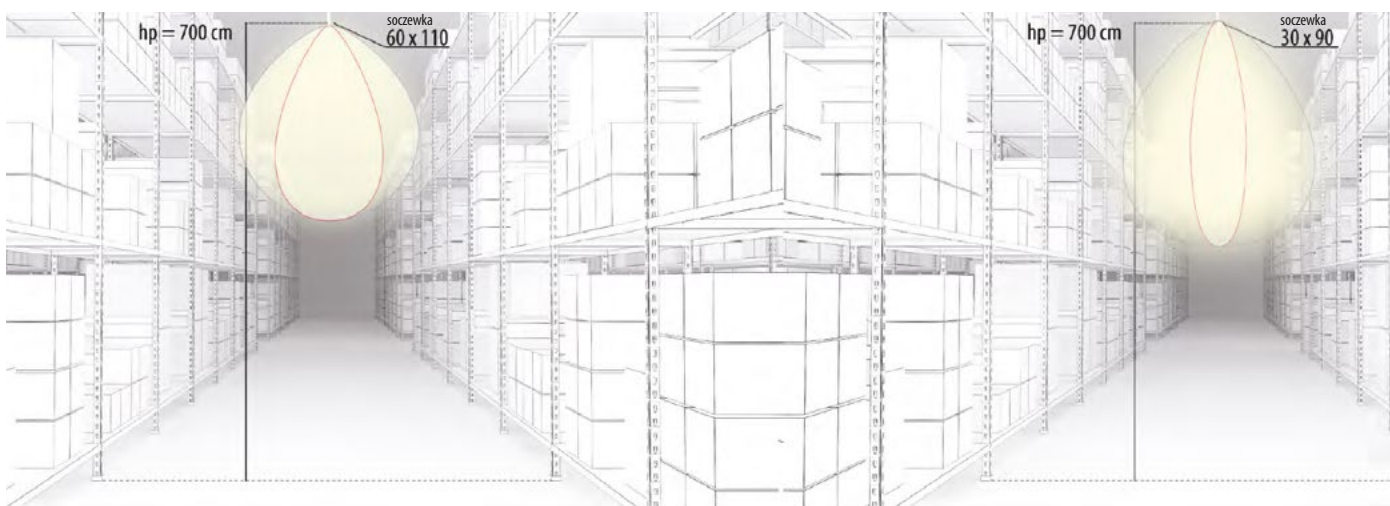



60-150cm
długości opraw

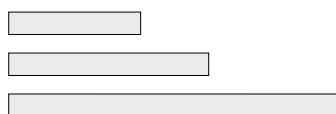

osłona przeciwośnieniowa
UGR<19



łącznik przegubowy
90-270°



maks. 60m





- biały
- szary
- czarny

beznarzędziowe
łączenie

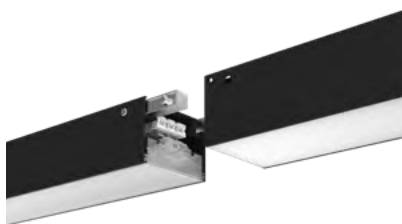

tworzenie różnych
kształtów

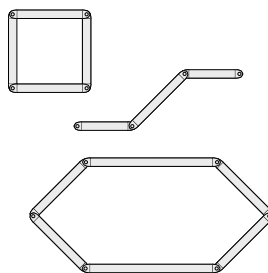

Oprawa liniowa FUSION 20W

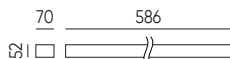

LED line PRIME

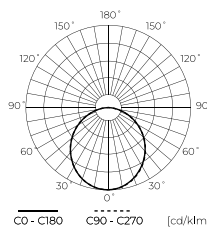
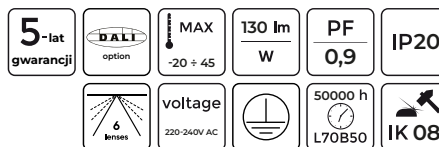

475466

475466



SYMBOL	NAZWA	KĄT ŚWIECENIA	MOC	TEMPERATURA BARWOWA	STRUMIEŃ ŚWIETLNY
475466	Oprawa liniowa FUSION 20W 2600lm 4000K PC Cover 120° czarna	120°	20W	4000K	2600lm
475480	Oprawa liniowa FUSION 20W 2600lm 4000K 30*90° czarna	30*90°	20W	4000K	2600lm
475497	Oprawa liniowa FUSION 20W 2600lm 4000K 60*110° czarna	60*110°	20W	4000K	2600lm
475503	Oprawa liniowa FUSION 20W 2600lm 4000K 90*110° czarna	90*110°	20W	4000K	2600lm
475602	Oprawa liniowa FUSION 20W 2600lm 4000K 120*120° czarna	120*120°	20W	4000K	2600lm
475619	Oprawa liniowa FUSION 20W 2600lm 4000K LR40 czarna	LR40	20W	4000K	2600lm
475626	Oprawa liniowa FUSION 20W 2600lm 4000K P18 czarna	P18	20W	4000K	2600lm

Oprawa liniowa FUSION 20W 0-10V

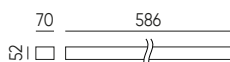

LED line PRIME

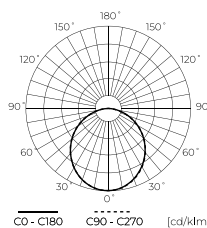
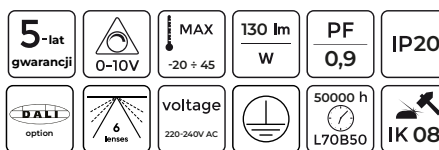

475633

475633



SYMBOL	NAZWA	KĄT ŚWIECENIA	MOC	TEMPERATURA BARWOWA	STRUMIEŃ ŚWIETLNY
475633	Oprawa liniowa FUSION 20W 2600lm 4000K 0-10V PC Cover 120° czarna	120°	20W	4000K	2600lm
475640	Oprawa liniowa FUSION 20W 2600lm 4000K 0-10V 30*90° czarna	30*90°	20W	4000K	2600lm
475657	Oprawa liniowa FUSION 20W 2600lm 4000K 0-10V 60*110° czarna	60*110°	20W	4000K	2600lm
475664	Oprawa liniowa FUSION 20W 2600lm 4000K 0-10V 90*110° czarna	90*110°	20W	4000K	2600lm
475701	Oprawa liniowa FUSION 20W 2600lm 4000K 0-10V 120*120° czarna	120*120°	20W	4000K	2600lm
475718	Oprawa liniowa FUSION 20W 2600lm 4000K 0-10V LR40 czarna	LR40	20W	4000K	2600lm
475725	Oprawa liniowa FUSION 20W 2600lm 4000K 0-10V P18 czarna	P18	20W	4000K	2600lm

Oprawa liniowa FUSION 40W

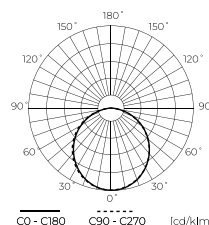
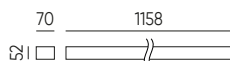
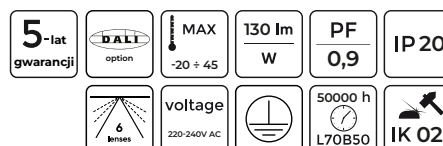

C0 - C180 C90 - C270 [cd/klm]
475732



475732



LED line PRIME

SYMBOL	NAZWA	KĄT ŚWIECENIA	MOC	TEMPERATURA BARWOWA	STRUMIEŃ ŚWIETLNY
475732	Oprawa liniowa FUSION 40W 5200lm 4000K PC Cover 120° czarna	120°	40W	4000K	5200lm
475749	Oprawa liniowa FUSION 40W 5200lm 4000K 30°*90° czarna	30°*90°	40W	4000K	5200lm
475756	Oprawa liniowa FUSION 40W 5200lm 4000K 60°*110° czarna	60°*110°	40W	4000K	5200lm
475763	Oprawa liniowa FUSION 40W 5200lm 4000K 90°*110° czarna	90°*110°	40W	4000K	5200lm
475800	Oprawa liniowa FUSION 40W 5200lm 4000K 120°*120° czarna	120°*120°	40W	4000K	5200lm
475817	Oprawa liniowa FUSION 40W 5200lm 4000K LR40 czarna	LR40	40W	4000K	5200lm
475824	Oprawa liniowa FUSION 40W 5200lm 4000K P18 czarna	P18	40W	4000K	5200lm

Oprawa liniowa FUSION 40W 0-10V

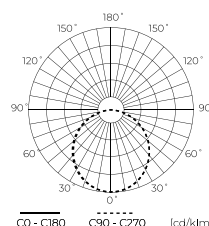
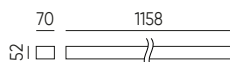
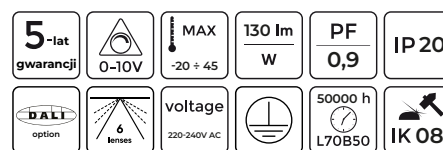

C0 - C180 C90 - C270 [cd/klm]
475831



475831



LED line PRIME

SYMBOL	NAZWA	KĄT ŚWIECENIA	MOC	TEMPERATURA BARWOWA	STRUMIEŃ ŚWIETLNY
475831	Oprawa liniowa FUSION 40W 5200lm 4000K 0-10V PC Cover 120° czarna	120°	40W	4000K	5200lm
475848	Oprawa liniowa FUSION 40W 5200lm 4000K 0-10V 30°*90° czarna	30°*90°	40W	4000K	5200lm
475855	Oprawa liniowa FUSION 40W 5200lm 4000K 0-10V 60°*110° czarna	60°*110°	40W	4000K	5200lm
475862	Oprawa liniowa FUSION 40W 5200lm 4000K 0-10V 90°*110° czarna	90°*110°	40W	4000K	5200lm
475909	Oprawa liniowa FUSION 40W 5200lm 4000K 0-10V 120°*120° czarna	120°*120°	40W	4000K	5200lm
475916	Oprawa liniowa FUSION 40W 5200lm 4000K 0-10V LR40 czarna	LR40	40W	4000K	5200lm
475923	Oprawa liniowa FUSION 40W 5200lm 4000K 0-10V P18 czarna	P18	40W	4000K	5200lm

Oprawa liniowa FUSION 60W

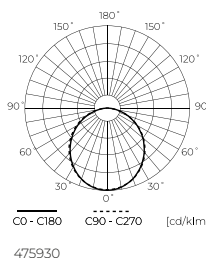
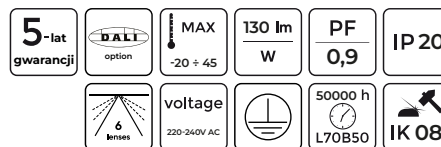
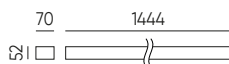

LED line PRIME

SYMBOL	NAZWA	KĄT ŚWIECENIA	MOC	TEMPERATURA BARWOWA	STRUMIEŃ ŚWIETLNY
475930	Oprawa liniowa FUSION 60W 7800lm 4000K PC Cover 120° czarna	120°	60W	4000K	7800lm
475947	Oprawa liniowa FUSION 60W 7800lm 4000K 30*90° czarna	30*90°	60W	4000K	7800lm
475954	Oprawa liniowa FUSION 60W 7800lm 4000K 60*110° czarna	60*110°	60W	4000K	7800lm
475961	Oprawa liniowa FUSION 60W 7800lm 4000K 90*110° czarna	90*110°	60W	4000K	7800lm
476012	Oprawa liniowa FUSION 60W 7800lm 4000K 120*120° czarna	120*120°	60W	4000K	7800lm
476029	Oprawa liniowa FUSION 60W 7800lm 4000K LR40 czarna	LR40	60W	4000K	7800lm
478962	Oprawa liniowa FUSION 60W 7800lm 4000K P18 czarna	P18	60W	4000K	7800lm

Oprawa liniowa FUSION 60W 0-10V

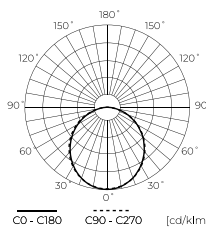
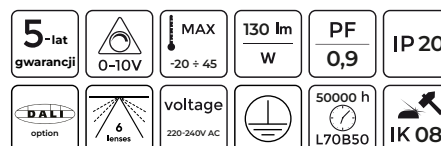
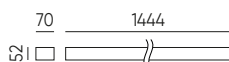

LED line PRIME

SYMBOL	NAZWA	KĄT ŚWIECENIA	MOC	TEMPERATURA BARWOWA	STRUMIEŃ ŚWIETLNY
478979	Oprawa liniowa FUSION 60W 7800lm 4000K 0-10V PC Cover 120° czarna	120°	60W	4000K	7800lm
478986	Oprawa liniowa FUSION 60W 7800lm 4000K 0-10V 30*90° czarna	30*90°	60W	4000K	7800lm
478993	Oprawa liniowa FUSION 60W 7800lm 4000K 0-10V 60*110° czarna	60*110°	60W	4000K	7800lm
479006	Oprawa liniowa FUSION 60W 7800lm 4000K 0-10V 90*110° czarna	90*110°	60W	4000K	7800lm
479662	Oprawa liniowa FUSION 60W 7800lm 4000K 0-10V 120*120° czarna	120*120°	60W	4000K	7800lm
479679	Oprawa liniowa FUSION 60W 7800lm 4000K 0-10V LR40 czarna	LR40	60W	4000K	7800lm
479686	Oprawa liniowa FUSION 60W 7800lm 4000K 0-10V P18 czarna	P18	60W	4000K	7800lm

Oprawa liniowa FUSION 20W

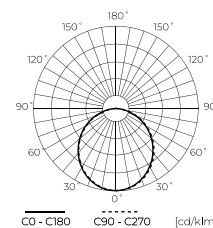
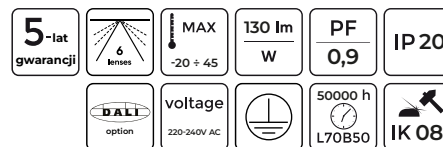
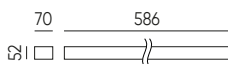

203259

203259

LED line PRIME

SYMBOL	NAZWA	KĄT ŚWIECENIA	MOC	TEMPERATURA BARWOWA	STRUMIEŃ ŚWIETLNY
203259	Oprawa liniowa FUSION 20W 2600lm 4000K PC Cover 120° biała	120°	20W	4000K	2600lm
203983	Oprawa liniowa FUSION 20W 2600lm 4000K 30*90° biała	30*90°	20W	4000K	2600lm
203990	Oprawa liniowa FUSION 20W 2600lm 4000K 60*110° biała	60*110°	20W	4000K	2600lm
204003	Oprawa liniowa FUSION 20W 2600lm 4000K 90*110° biała	90*110°	20W	4000K	2600lm
204010	Oprawa liniowa FUSION 20W 2600lm 4000K 120*120° biała	120*120°	20W	4000K	2600lm
204027	Oprawa liniowa FUSION 20W 2600lm 4000K LR40 biała	LR40	20W	4000K	2600lm
204034	Oprawa liniowa FUSION 20W 2600lm 4000K P18 biała	P18	20W	4000K	2600lm

Oprawa liniowa FUSION 20W 0-10V

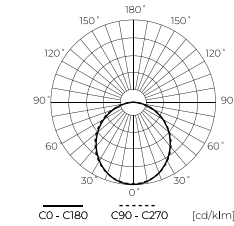
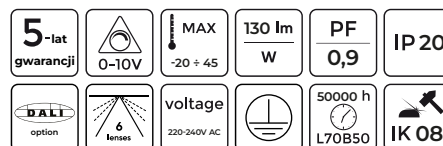
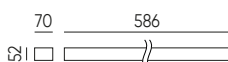

204041

204041

LED line PRIME

SYMBOL	NAZWA	KĄT ŚWIECENIA	MOC	TEMPERATURA BARWOWA	STRUMIEŃ ŚWIETLNY
204041	Oprawa liniowa FUSION 20W 2600lm 4000K 0-10V PC Cover 120° biała	120°	20W	4000K	2600lm
204508	Oprawa liniowa FUSION 20W 2600lm 4000K 0-10V 30*90° biała	30*90°	20W	4000K	2600lm
204058	Oprawa liniowa FUSION 20W 2600lm 4000K 0-10V 60*110° biała	60*110°	20W	4000K	2600lm
204065	Oprawa liniowa FUSION 20W 2600lm 4000K 0-10V 90*110° biała	90*110°	20W	4000K	2600lm
204072	Oprawa liniowa FUSION 20W 2600lm 4000K 0-10V 120*120° biała	120*120°	20W	4000K	2600lm
204089	Oprawa liniowa FUSION 20W 2600lm 4000K 0-10V LR40 biała	LR40	20W	4000K	2600lm
204096	Oprawa liniowa FUSION 20W 2600lm 4000K 0-10V P18 biała	P18	20W	4000K	2600lm

Oprawa liniowa FUSION 40W

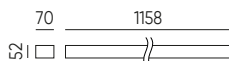

LED line PRIME

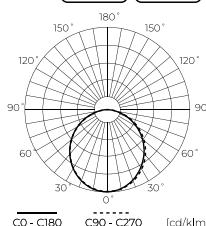
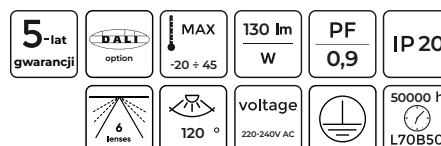

203266

203266

SYMBOL	NAZWA	KĄT ŚWIECENIA	MOC	TEMPERATURA BARWOWA	STRUMIEŃ ŚWIETLNY
203266	Oprawa liniowa FUSION 40W 5200lm 4000K PC Cover 120° biała	120°	40W	4000K	5200lm
204102	Oprawa liniowa FUSION 40W 5200lm 4000K 30*90° biała	30*90°	40W	4000K	5200lm
204119	Oprawa liniowa FUSION 40W 5200lm 4000K 60*110° biała	60*110°	40W	4000K	5200lm
204126	Oprawa liniowa FUSION 40W 5200lm 4000K 90*110° biała	90*110°	40W	4000K	5200lm
204133	Oprawa liniowa FUSION 40W 5200lm 4000K 120*120° biała	120*120°	40W	4000K	5200lm
204140	Oprawa liniowa FUSION 40W 5200lm 4000K LR40 biała	LR40	40W	4000K	5200lm
204157	Oprawa liniowa FUSION 40W 5200lm 4000K P18 biała	P18	40W	4000K	5200lm

Oprawa liniowa FUSION 40W 0-10V

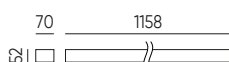

LED line PRIME

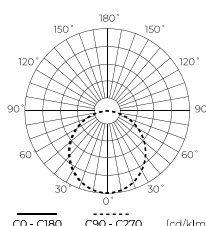
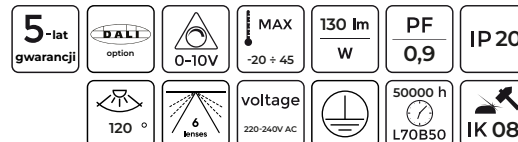

205574

205574

SYMBOL	NAZWA	KĄT ŚWIECENIA	MOC	TEMPERATURA BARWOWA	STRUMIEŃ ŚWIETLNY
205574	Oprawa liniowa FUSION 40W 5200lm 4000K 0-10V PC Cover 120° biała	120°	40W	4000K	5200lm
204164	Oprawa liniowa FUSION 40W 5200lm 4000K 0-10V 30*90° biała	30*90°	40W	4000K	5200lm
204171	Oprawa liniowa FUSION 40W 5200lm 4000K 0-10V 60*110° biała	60*110°	40W	4000K	5200lm
204188	Oprawa liniowa FUSION 40W 5200lm 4000K 0-10V 90*110° biała	90*110°	40W	4000K	5200lm
204195	Oprawa liniowa FUSION 40W 5200lm 4000K 0-10V 120*120° biała	120*120°	40W	4000K	5200lm
204201	Oprawa liniowa FUSION 40W 5200lm 4000K 0-10V LR40 biała	LR40	40W	4000K	5200lm
204218	Oprawa liniowa FUSION 40W 5200lm 4000K 0-10V P18 biała	P18	40W	4000K	5200lm

Oprawa liniowa FUSION 60W

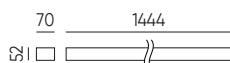

LED line PRIME

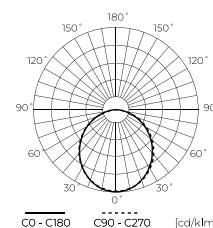
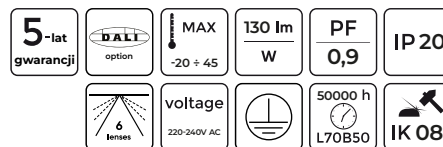

203273



203273

SYMBOL	NAZWA	KĄT ŚWIECENIA	MOC	TEMPERATURA BARWOWA	STRUMIEŃ ŚWIETLNY
203273	Oprawa liniowa FUSION 60W 7800lm 4000K PC Cover 120° biała	120°	60W	4000K	7800lm
204225	Oprawa liniowa FUSION 60W 7800lm 4000K 30*90° biała	30*90°	60W	4000K	7800lm
204232	Oprawa liniowa FUSION 60W 7800lm 4000K 60*110° biała	60*110°	60W	4000K	7800lm
204249	Oprawa liniowa FUSION 60W 7800lm 4000K 90*110° biała	90*110°	60W	4000K	7800lm
204256	Oprawa liniowa FUSION 60W 7800lm 4000K 120*120° biała	120*120°	60W	4000K	7800lm
204263	Oprawa liniowa FUSION 60W 7800lm 4000K LR40 biała	LR40	60W	4000K	7800lm
204270	Oprawa liniowa FUSION 60W 7800lm 4000K P18 biała	P18	60W	4000K	7800lm

Oprawa liniowa FUSION 60W 0-10V

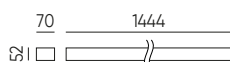

LED line PRIME

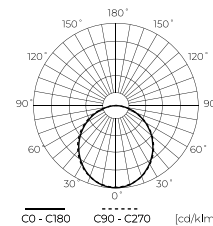
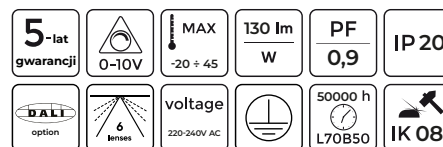

205581



205581

SYMBOL	NAZWA	KĄT ŚWIECENIA	MOC	TEMPERATURA BARWOWA	STRUMIEŃ ŚWIETLNY
205581	Oprawa liniowa FUSION 60W 7800lm 4000K 0-10V PC Cover 120° biała	120°	60W	4000K	7800lm
204287	Oprawa liniowa FUSION 60W 7800lm 4000K 0-10V 30*90° biała	30*90°	60W	4000K	7800lm
204294	Oprawa liniowa FUSION 60W 7800lm 4000K 0-10V 60*110° biała	60*110°	60W	4000K	7800lm
204300	Oprawa liniowa FUSION 60W 7800lm 4000K 0-10V 90*110° biała	90*110°	60W	4000K	7800lm
204317	Oprawa liniowa FUSION 60W 7800lm 4000K 0-10V 120*120° biała	120*120°	60W	4000K	7800lm
204324	Oprawa liniowa FUSION 60W 7800lm 4000K 0-10V LR40 biała	LR40	60W	4000K	7800lm
204331	Oprawa liniowa FUSION 60W 7800lm 4000K 0-10V P18 biała	P18	60W	4000K	7800lm

FUSION osłona przeciwolśnieniowa

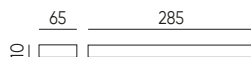

203587

LED line PRIME

SYMBOL	NAZWA	KOMPATYBILNE PRODUKTY
203587	FUSION osłona przeciwolśnieniowa UGR<19 czarna	FUSION 20W/40W/60W
203570	FUSION Osłona przeciwolśnieniowa UGR<19 biała	FUSION 20W/40W/60W

FUSION łącznik przegubowy



479709

LED line PRIME

SYMBOL	NAZWA	KOMPATYBILNE PRODUKTY	KĄT
479709	FUSION łącznik przegubowy czarny	FUSION 20W/40W/60W	-90° ÷ +90°
203426	FUSION łącznik przegubowy biały	FUSION 20W/40W/60W	-90° ÷ +90°



FUSION L łącznik



204553

LED line PRIME

SYMBOL	NAZWA	KOMPATYBILNE PRODUKTY	KĄT
204553	FUSION L łącznik czarny	FUSION 20W/40W/60W	90°
204560	FUSION L łącznik biały	FUSION 20W/40W/60W	90°

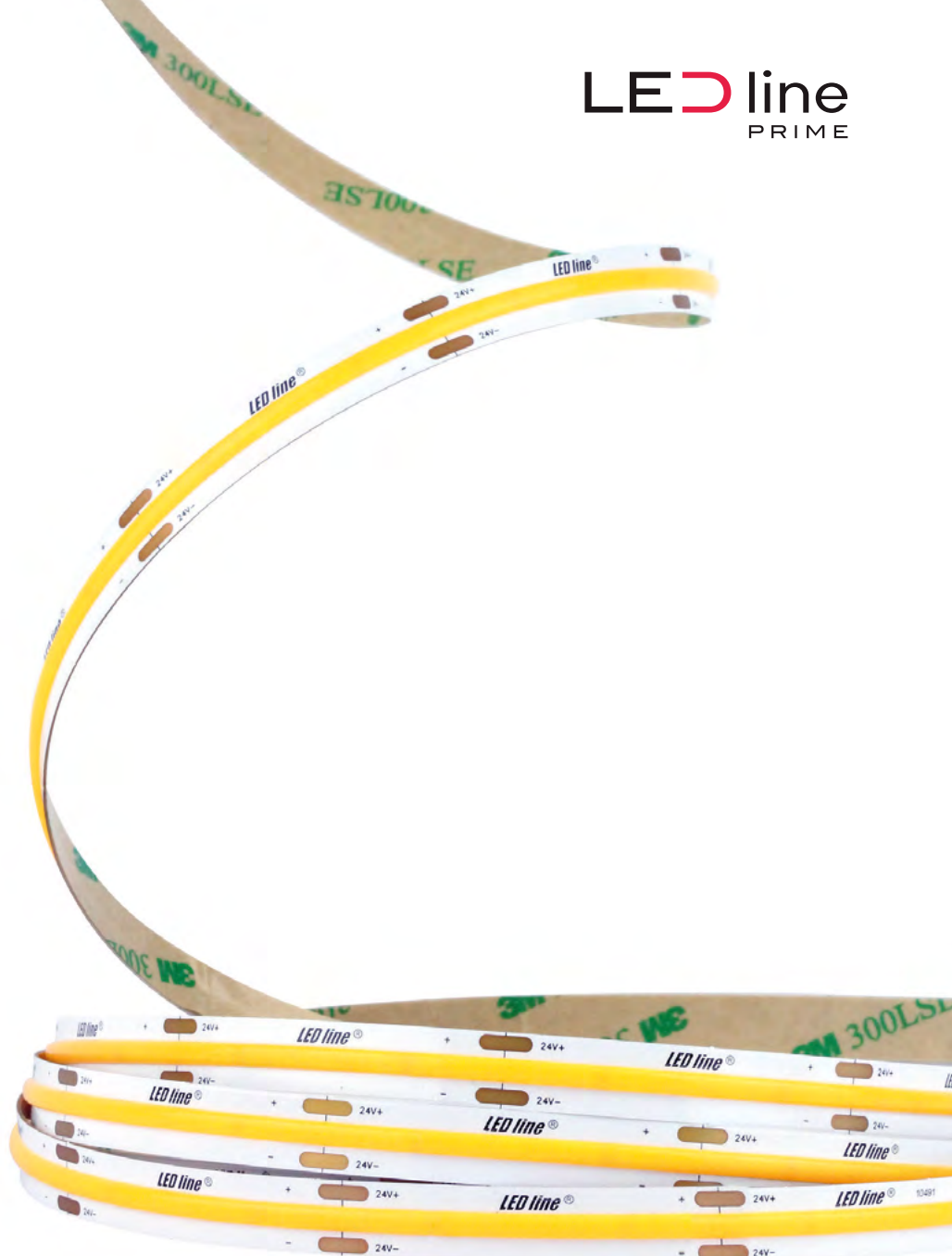

TAŚMA LED
COB

Taśma LED COB 24V biała IP20

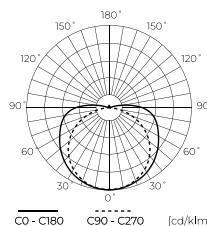
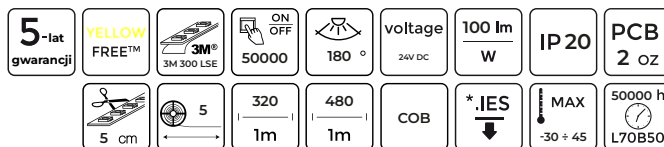

LED line PRIME

SYMBOL	NAZWA	MOC	TEMPERATURA BARWOWA	STRUMIEŃ ŚWIETLNY	ROLKA	NAPIĘCIE	TYP DIODY
476821	Taśma LED 320 COB 24V 2700K 8W	8 [W/m]	2700K	800 [lm/m]	5M	24V DC	COB
476838	Taśma LED 320 COB 24V 4000K 8W	8 [W/m]	4000K	800 [lm/m]	5M	24V DC	COB
476845	Taśma LED 320 COB 24V 6500K 8W	8 [W/m]	6500K	800 [lm/m]	5M	24V DC	COB
479754	Taśma LED 320 COB 24V 2700K 8W 30m	8 [W/m]	2700K	800 [lm/m]	30M	24V DC	COB
479761	Taśma LED 320 COB 24V 4000K 8W 30m	8 [W/m]	4000K	800 [lm/m]	30M	24V DC	COB
479778	Taśma LED 320 COB 24V 6500K 8W 30m	8 [W/m]	6500K	800 [lm/m]	30M	24V DC	COB
479785	Taśma LED 480 COB 24V 2700K 11W	11 [W/m]	2700K	1100 [lm/m]	5M	24V DC	COB
479792	Taśma LED 480 COB 24V 4000K 11W	11 [W/m]	4000K	1100 [lm/m]	5M	24V DC	COB
479808	Taśma LED 480 COB 24V 6500K 11W	11 [W/m]	6500K	1100 [lm/m]	5M	24V DC	COB
200005	Taśma LED 480 COB 24V 2700K 11W 30m	11 [W/m]	2700K	1100 [lm/m]	30M	24V DC	COB
200012	Taśma LED 480 COB 24V 4000K 11W 30m	11 [W/m]	4000K	1100 [lm/m]	30M	24V DC	COB
200029	Taśma LED 480 COB 24V 6500K 11W 30m	11 [W/m]	6500K	1100 [lm/m]	30M	24V DC	COB
479846	Taśma LED 528 COB 24V 2700K 14W	14 [W/m]	2700K	1400 [lm/m]	5M	24V DC	COB
479853	Taśma LED 528 COB 24V 4000K 14W	14 [W/m]	4000K	1400 [lm/m]	5M	24V DC	COB
479860	Taśma LED 528 COB 24V 6500K 14W	14 [W/m]	6500K	1400 [lm/m]	5M	24V DC	COB
200036	Taśma LED 528 COB 24V 2700K 14W 30m	14 [W/m]	2700K	1400 [lm/m]	30M	24V DC	COB
200043	Taśma LED 528 COB 24V 4000K 14W 30m	14 [W/m]	4000K	1400 [lm/m]	30M	24V DC	COB
200050	Taśma LED 528 COB 24V 6500K 14W 30m	14 [W/m]	6500K	1400 [lm/m]	30M	24V DC	COB
478245	Taśma LED 480 COB 24V 2700K 18W	18 [W/m]	2700K	1800 [lm/m]	5M	24V DC	COB
478269	Taśma LED 480 COB 24V 4000K 18W	18 [W/m]	4000K	1800 [lm/m]	5M	24V DC	COB
478313	Taśma LED 480 COB 24V 6500K 18W	18 [W/m]	6500K	1800 [lm/m]	5M	24V DC	COB
200098	Taśma LED 480 COB 24V 2700K 18W 30m	18 [W/m]	2700K	1800 [lm/m]	30M	24V DC	COB
200104	Taśma LED 480 COB 24V 4000K 18W 30m	18 [W/m]	4000K	1800 [lm/m]	30M	24V DC	COB
200111	Taśma LED 480 COB 24V 6500K 18W 30m	18 [W/m]	6500K	1800 [lm/m]	30M	24V DC	COB

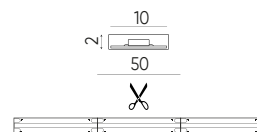
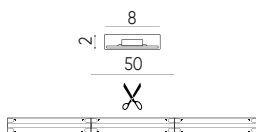

476821	479761	479808	479846	200043	478313
476838	479778	200005	479853	200050	200098
476845	479785	200012	479860	478245	200104
479754	479792	200029	200036	478269	200111

Taśma LED 576 COB 24V RGB IP20

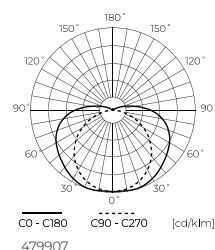
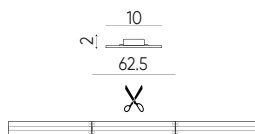
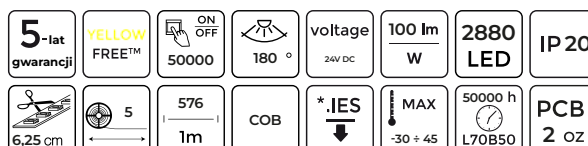

LED line PRIME

SYMBOL	NAZWA	MOC	KOLOR / DŁUGOŚĆ FALI	ROLKA	NAPIĘCIE	TYP DIODY
479907	Taśma LED 576 COB 24V RGB 10W	10 [W/m]	RGB / 620nm, 520nm, 465nm	5M	24V DC	COB
479921	Taśma LED 576 COB 24V RGB 10W 30m	10 [W/m]	RGB / 620nm, 520nm, 465nm	30M	24V DC	COB

Taśma LED 840 COB 24V RGB CCT IP20

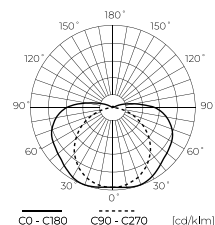
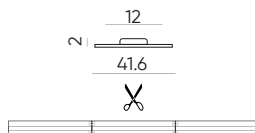
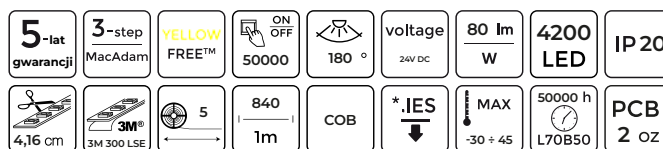

LED line PRIME

SYMBOL	NAZWA	MOC	TEMPERATURA BARWOWA	STRUMIEŃ ŚWIETLNY	ROLKA	NAPIĘCIE	TYP DIODY
200173	Taśma LED 840 COB 24V RGB CCT 18W	18 [W/m]	2700-6500K	720 [lm/m]	5M	24V DC	COB

Taśma LED COB 24V biała IP66



5-lat gwarancji	YELLOW FREE™	5	3-step MacAdam	ON OFF 50000	180°	voltage 24V DC	100 lm W	50000 h L70B50	IP 66
5 cm	4,6 cm	3M 3M 300 LSE	320 1m	480 1m	528 1m	COB	*.IES	MAX 30 ÷ 45	PCB 2 OZ



479723



LED line PRIME

SYMBOL	NAZWA	MOC	TEMPERATURA BARWOWA	STRUMIEŃ ŚWIETLNY	ROLKA	NAPIĘCIE	TYP DIODY
479723	Taśma LED 320 COB 24V 2700K 8W IP66	8 [W/m]	2700K	800 [lm/m]	5M	24V DC	COB
479730	Taśma LED 320 COB 24V 4000K 8W IP66	8 [W/m]	4000K	800 [lm/m]	5M	24V DC	COB
479747	Taśma LED 320 COB 24V 6500K 8W IP66	8 [W/m]	6500K	800 [lm/m]	5M	24V DC	COB
479815	Taśma LED 480 COB 24V 2700K 11W IP66	11 [W/m]	2700K	1100 [lm/m]	5M	24V DC	COB
479822	Taśma LED 480 COB 24V 4000K 11W IP66	11 [W/m]	4000K	1100 [lm/m]	5M	24V DC	COB
479839	Taśma LED 480 COB 24V 6500K 11W IP66	11 [W/m]	6000K	1100 [lm/m]	5M	24V DC	COB
479877	Taśma LED 528 COB 24V 2700K 14W IP66	14 [W/m]	2700K	1400 [lm/m]	5M	24V DC	COB
479884	Taśma LED 528 COB 24V 4000K 14W IP66	14 [W/m]	4000K	1400 [lm/m]	5M	24V DC	COB
479891	Taśma LED 528 COB 24V 6500K 14W IP66	14 [W/m]	6000K	1400 [lm/m]	5M	24V DC	COB



479723 479815
479730 479822
479747 479839

479877
479884
479891

Taśma LED COB 24V RGB IP66



5-lat gwarancji	YELLOW FREE™	PWM	ON OFF 50000	180°	voltage 24V DC	50000 h L70B50	IP 66
5	6,25 cm	3M 3M 300 LSE	576 1m	COB	*.IES	MAX 30 ÷ 45	PCB 2 OZ

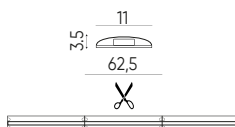

LED line PRIME

SYMBOL	NAZWA	MOC	KOLOR / DŁUGOŚĆ FALI	ROLKA	NAPIĘCIE	TYP DIODY
479914	Taśma LED 576 COB 24V RGB 10W IP66	10 [W/m]	RGB / 620nm, 520nm, 465nm	5M	24V DC	COB



TAŚMA LED
EXPERT

Taśma LED SMD2835 24V biały high-lumen IP20

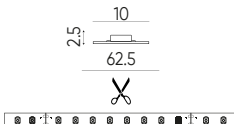
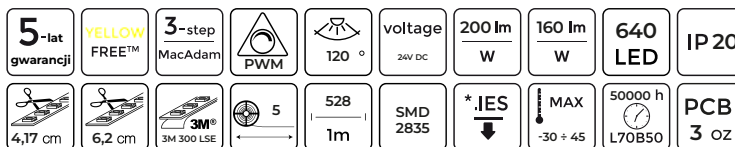

LED line PRIME

479945

SYMBOL	NAZWA	MOC	TEMPERATURA BARWOWA	STRUMIEŃ ŚWIETLNY	ROLKA	NAPIĘCIE	TYP DIODY
479945	Taśma LED 128 SMD2835 24V 2700K IP20 8,5W 160lm/W	8,5 [W/m]	2700K	1360 [lm/m]	5M	24V DC	SMD2835
479952	Taśma LED 128 SMD2835 24V 4000K IP20 8,5W 160lm/W	8,5 [W/m]	4000K	1360 [lm/m]	5M	24V DC	SMD2835
479969	Taśma LED 192 SMD2835 24V 2700K IP20 17,5W 160lm/W	17,5 [W/m]	2700K	2800 [lm/m]	5M	24V DC	SMD2835
479976	Taśma LED 192 SMD2835 24V 4000K IP20 17,5W 160lm/W	17,5 [W/m]	4000K	2800 [lm/m]	5M	24V DC	SMD2835
479983	Taśma LED 144 SMD2835 24V 2700K IP20 6,5W 200lm/W	6,5 [W/m]	2700K	1300 [lm/m]	5M	24V DC	SMD2835
479990	Taśma LED 144 SMD2835 24V 4000K IP20 6,5W 200lm/W	6,5 [W/m]	4000K	1300 [lm/m]	5M	24V DC	SMD2835

Taśma LED 300 SMD3528 MULTIWHITE CCT IP20 9,6W

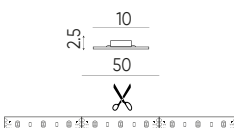
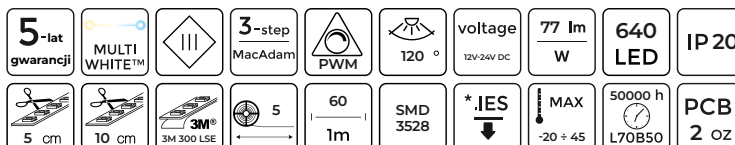

LED line PRIME

243714

SYMBOL	NAZWA	MOC	TEMPERATURA BARWOWA	STRUMIEŃ ŚWIETLNY	ROLKA	NAPIĘCIE	TYP DIODY
243714	Taśma LED 300 SMD2835 12V MULTIWHITE IP20 9,6W	9,6 [W/m]	3000K ÷ 6500K	800 [lm/m]	5M	12V DC	SMD2835
241819	Taśma LED 300 SMD2835 24V MULTIWHITE IP20 9,6W	9,6 [W/m]	3000K ÷ 6500K	800 [lm/m]	5M	24V DC	SMD2835

Taśma LED 60 SMD2835 24V 4000K IP20 14W CRI98

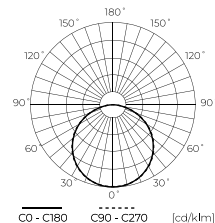
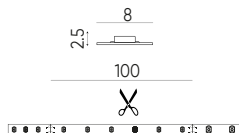
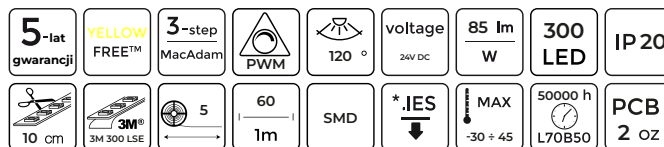

LED line PRIME

SYMBOL	NAZWA	MOC	TEMPERATURA BARWOWA	STRUMIEŃ ŚWIETLNY	ROLKA	NAPIĘCIE	TYP DIODY
479938	Taśma LED 60 SMD 24V 4000K 14W CRI98	14 [W/m]	4000K	1200 [lm/m]	5M	24V DC	SMD2835

Taśma LED 300 SMD5050 12V RGB 14.4 DIGITAL P943

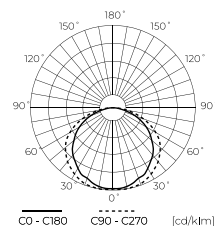
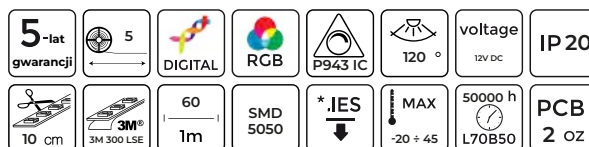

LED line PRIME

SYMBOL	NAZWA	MOC	KOLOR / DŁUGOŚĆ FALI	ROLKA	NAPIĘCIE	TYP DIODY
248238	Taśma LED 300 SMD 12V RGB 14,4W DIGITAL P943	14,4 [W/m]	RGB / 620nm, 520nm, 465nm	5M	12V DC	SMD5050

Taśma LED 600 SMD2216 12V 4000K IP20 5MM SLIM PCB 9,6W

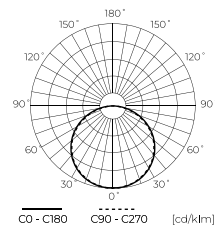
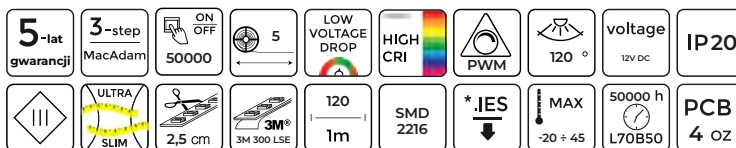

LED line PRIME

SYMBOL	NAZWA	MOC	TEMPERATURA BARWOWA	STRUMIEŃ ŚWIETLNY	ROLKA	NAPIĘCIE	TYP DIODY
249167	Taśma LED 600 SMD 12V 4000K 9,6W 5mm WPCB	9,6 [W/m]	4000K	740 [lm/m]	5M	12V DC	SMD2216



TAŚMA LED
CLASSIC

Taśma LED 300 SMD3528 12V 4,8W biały IP20

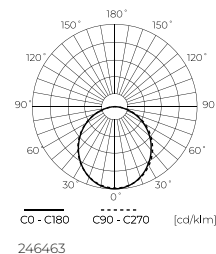
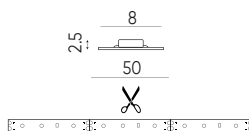
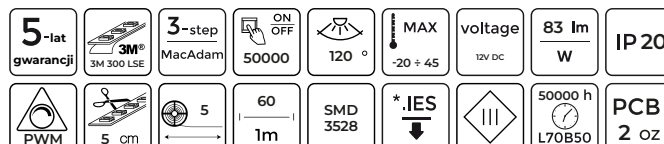

246463

LED line LITE

SYMBOL	NAZWA	MOC	TEMPERATURA BARWOWA	STRUMIEŃ ŚWIETLNY	ROLKA	NAPIĘCIE	TYP DIODY
246463	Taśma LED 300 SMD 12V 2400K 4,8W	4,8 [W/m]	2400K	400 [lm/m]	5M	12V DC	SMD3528
240164	Taśma LED 300 SMD 12V 3000K 4,8W	4,8 [W/m]	3000K	400 [lm/m]	5M	12V DC	SMD3528
249419	Taśma LED 300 SMD 12V 3000K 4,8W 30m	4,8 [W/m]	3000K	400 [lm/m]	30M	12V DC	SMD3528
477200	Taśma LED 300 SMD 12V 3000K 4,8W 50m	4,8 [W/m]	3000K	400 [lm/m]	50M	12V DC	SMD 3528
245602	Taśma LED 300 SMD 12V 4000K 4,8W	4,8 [W/m]	4000K	400 [lm/m]	5M	12V DC	SMD3528
249426	Taśma LED 300 SMD 12V 4000K 4,8W 30m	4,8 [W/m]	4000K	400 [lm/m]	30M	12V DC	SMD3528
477194	Taśma LED 300 SMD 12V 4000K 4,8W 50m	4,8 [W/m]	4000K	400 [lm/m]	50M	12V DC	SMD 3528
240188	Taśma LED 300 SMD 12V 6500K 4,8W	4,8 [W/m]	6500K	400 [lm/m]	5M	12V DC	SMD3528
249433	Taśma LED 300 SMD 12V 6500K 4,8W 30m	4,8 [W/m]	6500K	400 [lm/m]	30M	12V DC	SMD3528
477217	Taśma LED 300 SMD 12V 6500K 4,8W 50m	4,8 [W/m]	6500K	400 [lm/m]	50M	12V DC	SMD 3528
240195	Taśma LED 300 SMD 12V 11000K 4,8W	4,8 [W/m]	11000K	400 [lm/m]	5M	12V DC	SMD3528
249440	Taśma LED 300 SMD 12V 11000K 4,8W 30m	4,8 [W/m]	11000K	400 [lm/m]	30M	12V DC	SMD3528

Taśma LED 300 SMD3528 24V 4,8W biały IP20

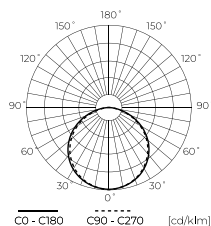
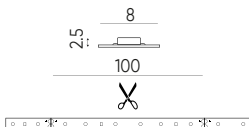
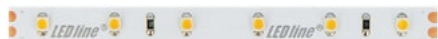
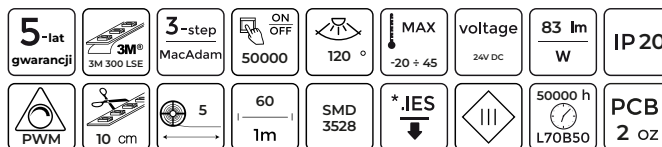

240645

240645



LED line LITE

SYMBOL	NAZWA	MOC	TEMPERATURA BARWOWA	STRUMIEŃ ŚWIETLNY	ROLKA	NAPIĘCIE	TYP DIODY
240645	Taśma LED 300 SMD 24V 3000K 4,8W	4,8 [W/m]	3000K	400 [lm/m]	5M	24V DC	SMD3528
241758	Taśma LED 300 SMD 24V 3000K 4,8W 30m	4,8 [W/m]	3000K	400 [lm/m]	30M	24V DC	SMD3528
240652	Taśma LED 300 SMD 24V 4000K 4,8W	4,8 [W/m]	4000K	400 [lm/m]	5M	24V DC	SMD3528
241765	Taśma LED 300 SMD 24V 4000K 4,8W 30m	4,8 [W/m]	4000K	400 [lm/m]	30M	24V DC	SMD3528
240676	Taśma LED 300 SMD 24V 6500K 4,8W	4,8 [W/m]	6500K	400 [lm/m]	5M	24V DC	SMD3528
241789	Taśma LED 300 SMD 24V 6500K 4,8W 30m	4,8 [W/m]	6500K	400 [lm/m]	30M	24V DC	SMD3528
240690	Taśma LED 300 SMD 24V 11000K 4,8W	4,8 [W/m]	11000K	400 [lm/m]	5M	24V DC	SMD3528
241796	Taśma LED 300 SMD 24V 11000K 4,8W 30m	4,8 [W/m]	11000K	400 [lm/m]	30M	24V DC	SMD3528

Taśma LED 300 SMD3528 12V 4,8W Kolor IP20

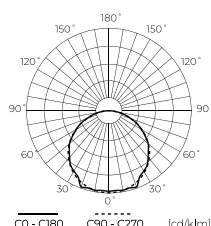
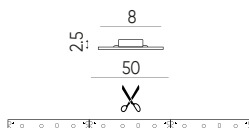
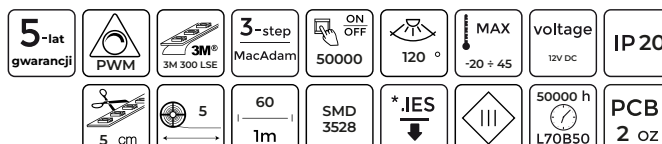

240201

240201

LED line LITE

SYMBOL	NAZWA	MOC	KOLOR / DŁUGOŚĆ FALI	ROLKA	NAPIĘCIE	TYP DIODY
240201	Taśma LED 300 SMD 12V czerwona 4,8W	4,8 [W/m]	Czerwony / 620nm	5M	12V DC	SMD3528
240225	Taśma LED 300 SMD 12V zielona 4,8W	4,8 [W/m]	Zielony / 520nm	5M	12V DC	SMD3528
240218	Taśma LED 300 SMD 12V niebieska 4,8W	4,8 [W/m]	Niebieski / 465nm	5M	12V DC	SMD3528
240232	Taśma LED 300 SMD 12V żółta 4,8W	4,8 [W/m]	Żółty / 590nm	5M	12V DC	SMD3528

Taśma LED 600 SMD2835 12V 9,6W biały IP20

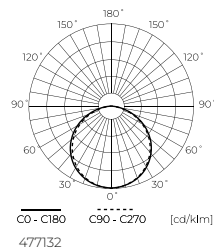
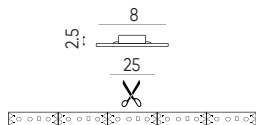
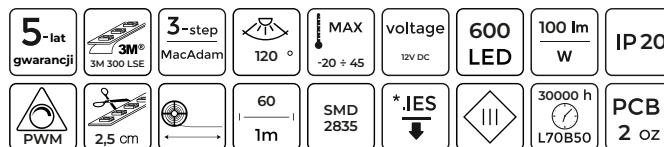

477132



LED line LITE

SYMBOL	NAZWA	MOC	TEMPERATURA BARWOWA	STRUMIEŃ ŚWIETLNY	ROLKA	NAPIĘCIE	TYP DIODY
477132	Taśma LED 600 SMD 12V 2700K 9,6W	9,6 [W/m]	2700K	960 [lm/m]	5M	12V DC	SMD 2835
477262	Taśma LED 600 SMD 12V 2700K 9,6W 30m	9,6 [W/m]	2700K	960 [lm/m]	30M	12V DC	SMD 2835
477149	Taśma LED 600 SMD 12V 4000K 9,6W	9,6 [W/m]	4000K	960 [lm/m]	5M	12V DC	SMD 2835
477279	Taśma LED 600 SMD 12V 4000K 9,6W 30m	9,6 [W/m]	4000K	960 [lm/m]	30M	12V DC	SMD 2835
477156	Taśma LED 600 SMD 12V 6500K 9,6W	9,6 [W/m]	6500K	960 [lm/m]	5M	12V DC	SMD 2835
477118	Taśma LED 600 SMD 12V 4000K 9,6W	9,6 [W/m]	11000K	960 [lm/m]	5M	12V DC	SMD 2835

Taśma LED 150/300 SMD5050 RGB IP20

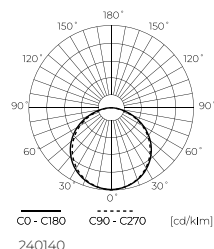
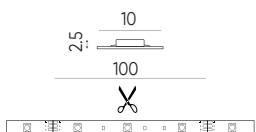
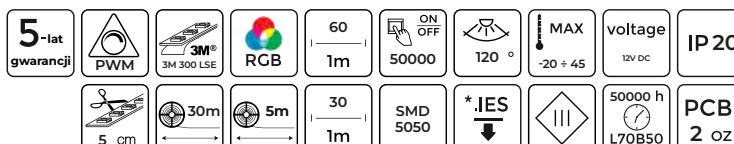

240140

LED line LITE

SYMBOL	NAZWA	MOC	KOLOR / DŁUGOŚĆ FALI	ROLKA	NAPIĘCIE	TYP DIODY
240140	Taśma LED 150 SMD 12V RGB 7,2W	7,2 [W/m]	RGB/ 620nm, 520nm, 465nm	5M	12V DC	SMD5050
240522	Taśma LED 300 SMD 12V RGB 14,4W	14,4 [W/m]	RGB/620nm, 520nm, 465nm	5M	12V DC	SMD5050
477255	Taśma LED 300 SMD 12V RGB 14,4W 30m	14,4 [W/m]	RGB/620nm, 520nm, 465nm	30M	12V DC	SMD5050
240539	Taśma LED 300 SMD 24V RGB 14,4W	14,4 [W/m]	RGB/620nm, 520nm, 465nm	5M	24V DC	SMD5050
477675	Taśma LED 300 SMD 24V RGB 14,4W 30m	14,4 [W/m]	RGB/620nm, 520nm, 465nm	30M	24V DC	SMD5050

Taśma LED 300 SMD5050 RGBW IP20

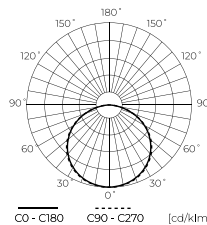
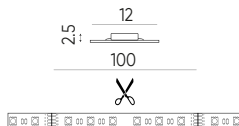
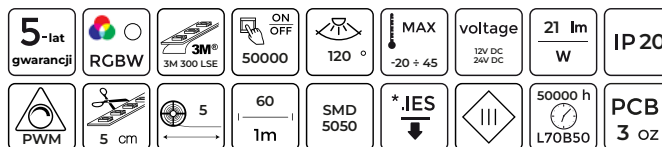

247071

247071



LED line LITE

SYMBOL	NAZWA	MOC	TEMPERATURA BARWOWA	STRUMIEŃ ŚWIETLNY	ROLKA	NAPIĘCIE	TYP DIODY
247071	Taśma LED 300 SMD 12V 2700K RGBW 19,2W	19,2 [W/m]	2700K	400 [lm/m]	5M	12V DC	SMD5050
477231	Taśma LED 300 SMD 12V 2700K RGBW 19,2W 30m	19,2 [W/m]	2700K	400 [lm/m]	30M	12V DC	SMD 5050
477309	Taśma LED 300 SMD 12V 4000K RGBW 19,2W	19,2 [W/m]	4000K	400 [lm/m]	5M	12V DC	SMD 5050
245657	Taśma LED 300 SMD 12V 6500K RGBW 19,2W	19,2 [W/m]	6500K	400 [lm/m]	5M	12V DC	SMD5050
477248	Taśma LED 300 SMD 12V 6500K RGBW 19,2W 30m	19,2 [W/m]	6500K	400 [lm/m]	30M	12V DC	SMD 5050
241673	Taśma LED 300 SMD 24V 2700K RGBW 19,2W	19,2 [W/m]	2700K	400 [lm/m]	5M	24V DC	SMD5050
477316	Taśma LED 300 SMD 24V 4000K RGBW 19,2W	19,2 [W/m]	4000K	400 [lm/m]	5M	24V DC	SMD 5050
241680	Taśma LED 300 SMD 24V 6500K RGBW 19,2W	19,2 [W/m]	6500K	400 [lm/m]	5M	24V DC	SMD5050



TAŚMA LED
WATERPROOF

Taśma LED 300 SMD2835 12V 4,8W biała IP65

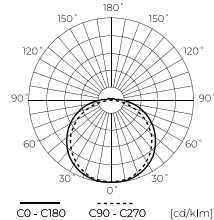
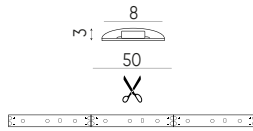
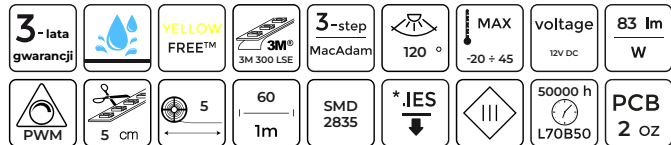

240249

240249

LED line LITE

SYMBOL	NAZWA	MOC	TEMPERATURA BARWOWA	STRUMIEŃ ŚWIETLNY	ROLKA	NAPIĘCIE	TYP DIODY
240249	Taśma LED 300 SMD 12V 3000K 4,8W IP65	4,8 [W/m]	3000K	400 [lm/m]	5M	12V DC	SMD3528
245619	Taśma LED 300 SMD 12V 4000K 4,8W IP65	4,8 [W/m]	4000K	400 [lm/m]	5M	12V DC	SMD3528
240256	Taśma LED 300 SMD 12V 6500K 4,8W IP65	4,8 [W/m]	6500K	400 [lm/m]	5M	12V DC	SMD3528
240263	Taśma LED 300 SMD 12V 11000K 4,8W IP65	4,8 [W/m]	11000K	400 [lm/m]	5M	12V DC	SMD3528

Taśma LED 300 SMD3528 24V 4,8W biała IP65

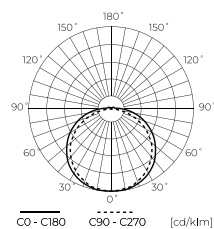
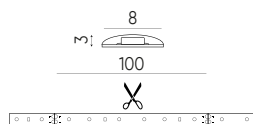

240713

240713

LED line LITE

SYMBOL	NAZWA	MOC	TEMPERATURA BARWOWA	STRUMIEŃ ŚWIETLNY	ROLKA	NAPIĘCIE	TYP DIODY
240713	Taśma LED 300 SMD 24V 3000K 4,8W IP65	4,8 [W/m]	3000K	400 [lm/m]	5M	24V DC	SMD3528
240720	Taśma LED 300 SMD 24V 4000K 4,8W IP65	4,8 [W/m]	4000K	400 [lm/m]	5M	24V DC	SMD3528
240744	Taśma LED 300 SMD 24V 6500K 4,8W IP65	4,8 [W/m]	6500K	400 [lm/m]	5M	24V DC	SMD3528
241147	Taśma LED 300 SMD 24V 11000K 4,8W IP65	4,8 [W/m]	11000K	400 [lm/m]	5M	24V DC	SMD3528

Taśma LED 300 SMD3528 12V 4,8W biała IP67

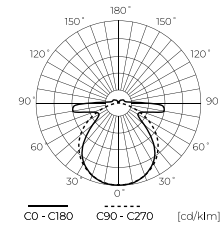
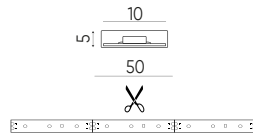
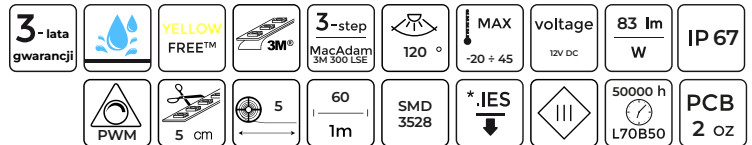

241468

241468

LED line LITE

SYMBOL	NAZWA	MOC	TEMPERATURA BARWOWA	STRUMIEŃ ŚWIETLNY	ROLKA	NAPIĘCIE	TYP DIODY
241468	Taśma LED 300 SMD 12V 3000K 4,8W IP67	4,8 [W/m]	3000K	400 [lm/m]	5M	12V DC	SMD3528
245626	Taśma LED 300 SMD 12V 4000K 4,8W IP67	4,8 [W/m]	4000K	400 [lm/m]	5M	12V DC	SMD3528

Taśma LED 300 SMD3528 12V 4,8W kolor IP65

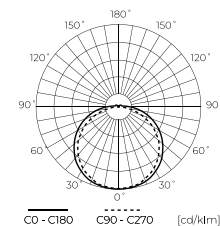
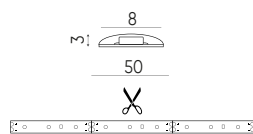
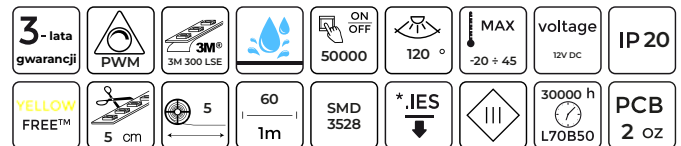

240270

240270

LED line LITE

SYMBOL	NAZWA	MOC	KOLOR / DŁUGOŚĆ FALI	STRUMIEŃ ŚWIETLNY	ROLKA	NAPIĘCIE	TYP DIODY
240270	Taśma LED 300 SMD 12V czerwona 4,8W IP65	4,8 [W/m]	Czerwony / 620nm	400 [lm/m]	5M	12V DC	SMD3528
240294	Taśma LED 300 SMD 12V zielona 4,8W IP65	4,8 [W/m]	Zielony / 520nm	400 [lm/m]	5M	12V DC	SMD3528
240287	Taśma LED 300 SMD 12V niebieska 4,8W IP65	4,8 [W/m]	Niebieski / 465nm	400 [lm/m]	5M	12V DC	SMD3528

Taśma LED 600 SMD2835 12V 9,6W biała IP65

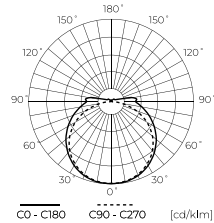
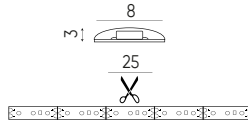
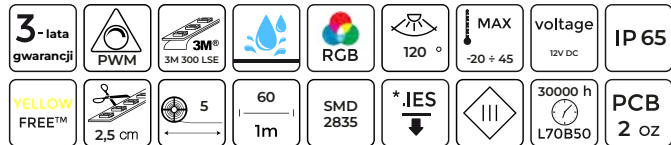

471345

471345



LED line LITE

SYMBOL	NAZWA	MOC	TEMPERATURA BARWOWA	STRUMIEŃ ŚWIETLNY	ROLKA	NAPIĘCIE	TYP DIODY
471345	Taśma LED 600 SMD 12V 2700K 9,6W IP65	9,6 [W/m]	2700K	960 [lm/m]	5M	12V DC	SMD 2835
477040	Taśma LED 600 SMD 12V 4000K 9,6W IP65	9,6 [W/m]	4000K	960 [lm/m]	5M	12V DC	SMD 2835
477057	Taśma LED 600 SMD 12V 6500K 9,6W IP65	9,6 [W/m]	6500K	960 [lm/m]	5M	12V DC	SMD 2835

Taśma LED 300 SMD5050 12V RGB IP67

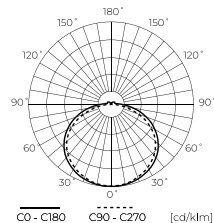
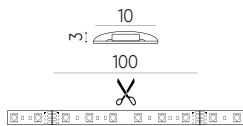
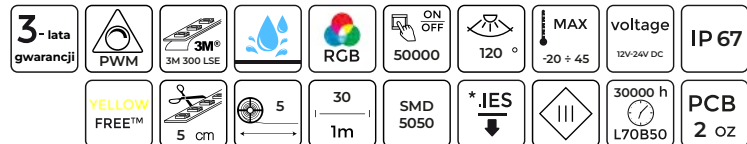

240157

240157

LED line LITE

SYMBOL	NAZWA	MOC	KOLOR / DŁUGOŚĆ FALI	ROLKA	NAPIĘCIE	TYP DIODY
240157	Taśma LED 150 SMD 12V RGB 7,2W IP65	7,2 [W/m]	RGB/620nm, 520nm, 465nm	5M	12V DC	SMD5050
240614	Taśma LED 300 SMD 12V RGB 14,4W IP65	14,4 [W/m]	RGB/620nm, 520nm, 465nm	5M	12V DC	SMD5060
241741	Taśma LED 300 SMD 24V RGB 14,4W IP65	14,4 [W/m]	RGB/620nm, 520nm, 465nm	5M	24V DC	SMD5050

Taśma LED 300 SMD5050 RGB IP67

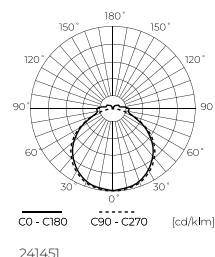
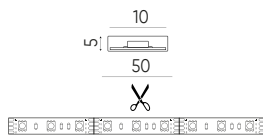
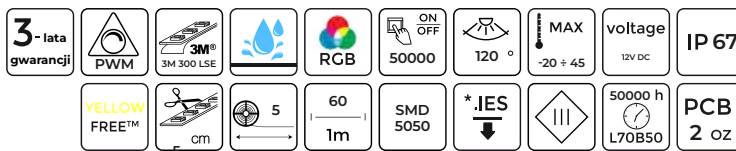

241451

LED line LITE

SYMBOL	NAZWA	MOC	KOLOR / DŁUGOŚĆ FALI	ROLKA	NAPIĘCIE	TYP DIODY
241451	Taśma LED 300 SMD 12V RGB 14,4W IP67	14,4 [W/m]	RGB/ 620nm, 520nm, 465nm	5M	12V DC	SMD5050

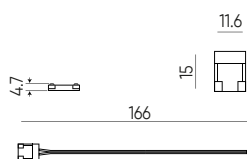

TAŚMA LED
AKCESORIA

**Złączka taśm COB CLICK CONNECTOR
 pojedyncza z przewodem 10 mm 2 PIN**

SYMBOL	NAZWA	TYP	TYP ZŁĄCZA	SZEROKOŚĆ TAŚMY LED	TYP DIODY
478351	Złączka do taśm COB CLICK CONNECTOR pojedyncza 10 mm 2 PIN z przewodem	2PIN	pojedyncze + przewód	10 mm	COB

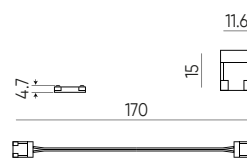
**Złączka taśm COB CLICK CONNECTOR
 podwójna 10 mm 2 PIN z kablem**

SYMBOL	NAZWA	TYP	TYP ZŁĄCZA	SZEROKOŚĆ TAŚMY LED	TYP DIODY
478368	Złączka do taśm COB CLICK CONNECTOR podwójna 10 mm 2 PIN z przewodem	2PIN	podwójne + przewód	10 mm	COB

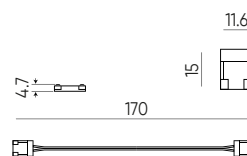
**Złączka taśm COB CLICK CONNECTOR
 pojedyncza z przewodem 8 mm 2 PIN**

SYMBOL	NAZWA	TYP	TYP ZŁĄCZA	SZEROKOŚĆ TAŚMY LED	TYP DIODY
202481	Złączka do taśm COB CLICK CONNECTOR pojedyncza 8 mm 2 PIN z przewodem	2PIN	pojedyncze + przewód	8 mm	COB

Złączka taśm COB LED łącznik kątowy 2 PIN Typ L

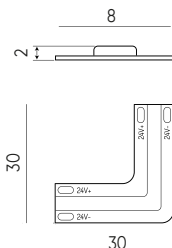

200456

LED line PRIME

SYMBOL	NAZWA	TYP	TYP ŁĄCZNIKA	SZEROKOŚĆ ZŁĄCZKI	TEMPERATURA BARWOWA	TYP DIODY
200456	Złączka taśm COB LED łącznik kątowy 2700K 8mm 2 PIN Typ L 8W	2PIN	L	8 mm	2700K	COB
200463	Złączka taśm COB LED łącznik kątowy 4000K 8mm 2 PIN Typ L 8W	2PIN	L	8 mm	4000K	COB
200470	Złączka taśm COB LED łącznik kątowy 6500K 8mm 2 PIN Typ L 8W	2PIN	L	8 mm	6500K	COB
200487	Złączka taśm COB LED łącznik kątowy 2700K 8mm 2 PIN Typ L 11W	2PIN	L	8 mm	2700K	COB
200494	Złączka taśm COB LED łącznik kątowy 4000K 8mm 2 PIN Typ L 11W	2PIN	L	8 mm	4000K	COB
200500	Złączka taśm COB LED łącznik kątowy 6500K 8mm 2 PIN Typ L 11W	2PIN	L	8 mm	6500K	COB
200517	Złączka taśm COB LED łącznik kątowy 2700K 10mm 2 PIN Typ L 14W	2PIN	L	10 mm	2700K	COB
200524	Złączka taśm COB LED łącznik kątowy 4000K 10mm 2 PIN Typ L 14W	2PIN	L	10 mm	4000K	COB
200531	Złączka taśm COB LED łącznik kątowy 6500K 10mm 2 PIN Typ L 14W	2PIN	L	10 mm	6500K	COB

Złączka taśm COB CLICK łącznik kątowy 2 PIN Typ L

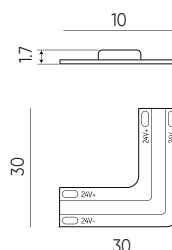
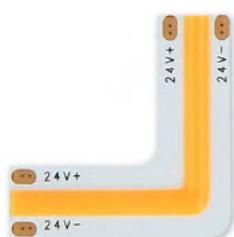

478412

LED line PRIME

SYMBOL	NAZWA	TYP	TYP ŁĄCZNIKA	SZEROKOŚĆ ZŁĄCZKI	TEMPERATURA BARWOWA	TYP DIODY
478412	Złączka taśm COB CLICK łącznik kątowy 2700K 10 mm 2 PIN Typ L 18W	2PIN	L	10 mm	2700K	COB
478429	Złączka taśm COB CLICK łącznik kątowy 4000K 10 mm 2 PIN Typ L 18W	2PIN	L	10 mm	4000K	COB
478436	Złączka taśm COB CLICK łącznik kątowy 6000K 10 mm 2 PIN Typ L 18W	2PIN	L	10 mm	6500K	COB

Złączka taśm COB CLICK CONNECTOR podwójna 2 PIN

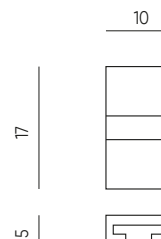

200609

LED line PRIME

SYMBOL	NAZWA	TYP	SZEROKOŚĆ ZŁĄCZKI	TYP DIODY
200609	Złączka taśm COB CLICK CONNECTOR podwójna 8mm 2 PIN	2PIN	8mm	COB
200616	Złączka taśm COB CLICK CONNECTOR podwójna 10mm 2 PIN	2PIN	10mm	COB

Złączka taśm COB CLICK CONNECTOR podwójna 2 PIN Typ L

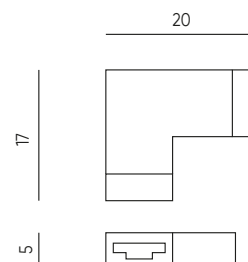

200548

LED line PRIME

SYMBOL	NAZWA	TYP	SZEROKOŚĆ ZŁĄCZKI	TYP DIODY
200548	Złączka taśm COB CLICK CONNECTOR podwójna 8mm 2 PIN Typ L	2PIN	8mm	COB
200555	Złączka taśm COB CLICK CONNECTOR podwójna 10mm 2 PIN Typ L	2PIN	10mm	COB

COB RGB Złączka taśm CLICK CONNECTOR podwójna 10mm 4 PIN

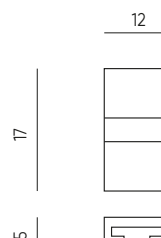

200623

LED line PRIME

SYMBOL	NAZWA	TYP	SZEROKOŚĆ	TYP DIODY
200623	COB RGB Złączka taśm CLICK CONNECTOR podwójna 10mm 4 PIN	4PIN	10mm	COB

Taśma COB CLICK Łącznik kątowy Typ T

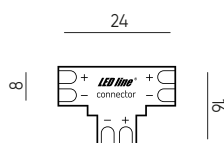

246555

LED line PRIME

SYMBOL	NAZWA	TYP	TYP ŁĄCZNIKA	TAŚMA LED WIDTH	TYP DIODY
246555	Taśma COB CLICK Łącznik kątowy 8 mm 2 PIN Typ T	2PIN	T	8mm	biały/kolorowy
246524	Taśma COB CLICK Łącznik kątowy 10 mm 4 PIN Typ T RGB	4PIN	T	10mm	RGB

Taśma COB CLICK Łącznik kątowy Typ L

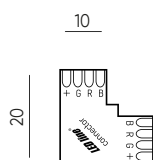

246562

LED line PRIME

SYMBOL	NAZWA	TYP	TYP ŁĄCZNIKA	TAŚMA LED WIDTH	TYP DIODY
246562	Taśma COB CLICK Łącznik kątowy 8 mm 2 PIN Typ L	2PIN	L	8mm	biały/kolorowy
246517	Taśma COB CLICK Łącznik kątowy 10 mm 4 PIN Typ L RGB	4PIN	L	10mm	RGB

Taśma COB CLICK Łącznik kątowy Typ +

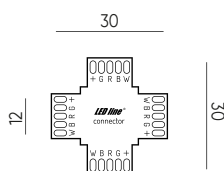

246548

LED line PRIME

SYMBOL	NAZWA	TYP	TYP ŁĄCZNIKA	TAŚMA LED WIDTH	TYP DIODY
246548	Taśma COB CLICK Łącznik kątowy 8 mm 2 PIN Typ +	2PIN	+	8mm	biały/kolorowy
246531	Taśma COB CLICK Łącznik kątowy 10 mm 4 PIN Typ + RGB	4PIN	+	10mm	RGB
247859	Taśma COB CLICK Łącznik kątowy 12 mm 5 PIN Typ + RGBW	5PIN	+	12mm	RGBW

Zacisk montażowy taśmy

IP20

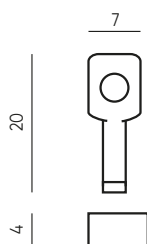

200586

LED line PRIME

SYMBOL	NAZWA	SZEROKOŚĆ TAŚMY LED	TYP DIODY
200586	Zacisk montażowy taśmy clip 8mm	8mm	COB
200593	Zacisk montażowy taśmy clip 10mm	10mm	COB

Uchwyt montażowy taśmy

IP20

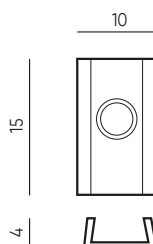

200562

LED line PRIME

SYMBOL	NAZWA	SZEROKOŚĆ TAŚMY LED	TYP DIODY
200562	Uchwyt montażowy taśmy 8mm	8mm	SMD, COB
200579	Uchwyt montażowy taśmy 10mm	10mm	SMD, COB





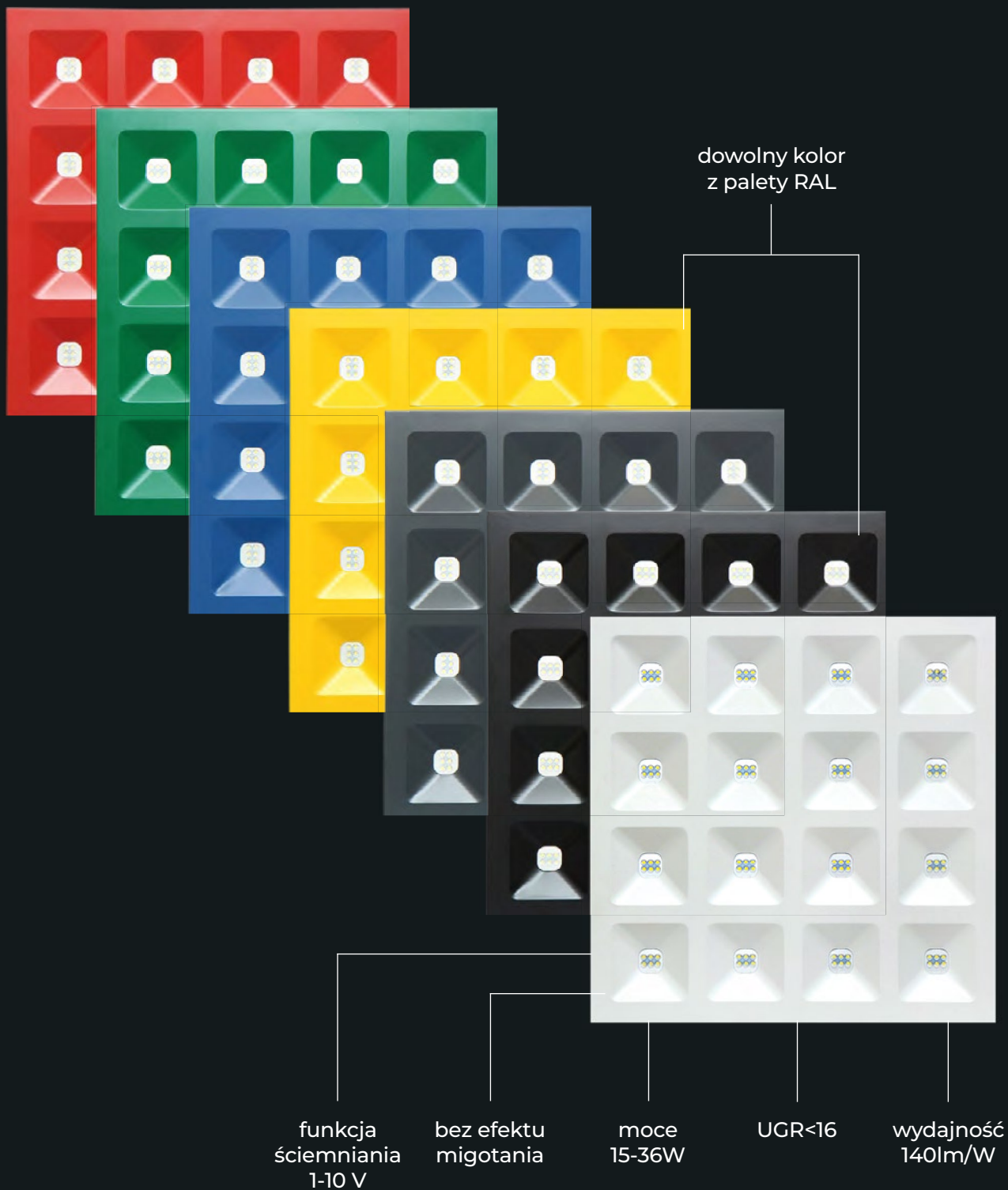

PANEL LED DIORA

Panel DIORA 4000K

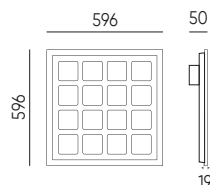
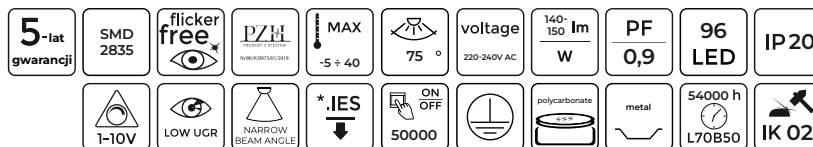

244193

LED line PRIME

SYMBOL	NAZWA	KĄT ŚWIECENIA	MOC	TEMPERATURA BARWOWA	STRUMIEŃ ŚWIETLNY
244193	Panel DIORA 15-36W 2250-5040lm 4000K	75°	15-36W	4000K	2250-5040lm
471260	Panel DIORA 36W 5040lm 4000K 1-10V	75°	36W	4000K	5040lm

wydajność
120lm/W

**montaż natynkowy -
najszybszy
na rynku**

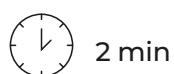

PANEL LED
PANEL 2in1

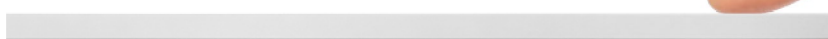

**najcieńszy korpus
na rynku**

595x595mm

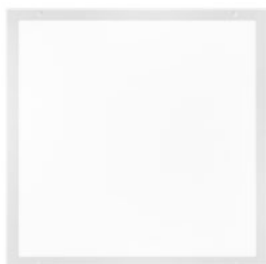

1195x295mm

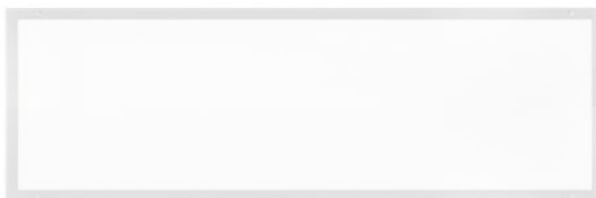

montaż podtynkowy

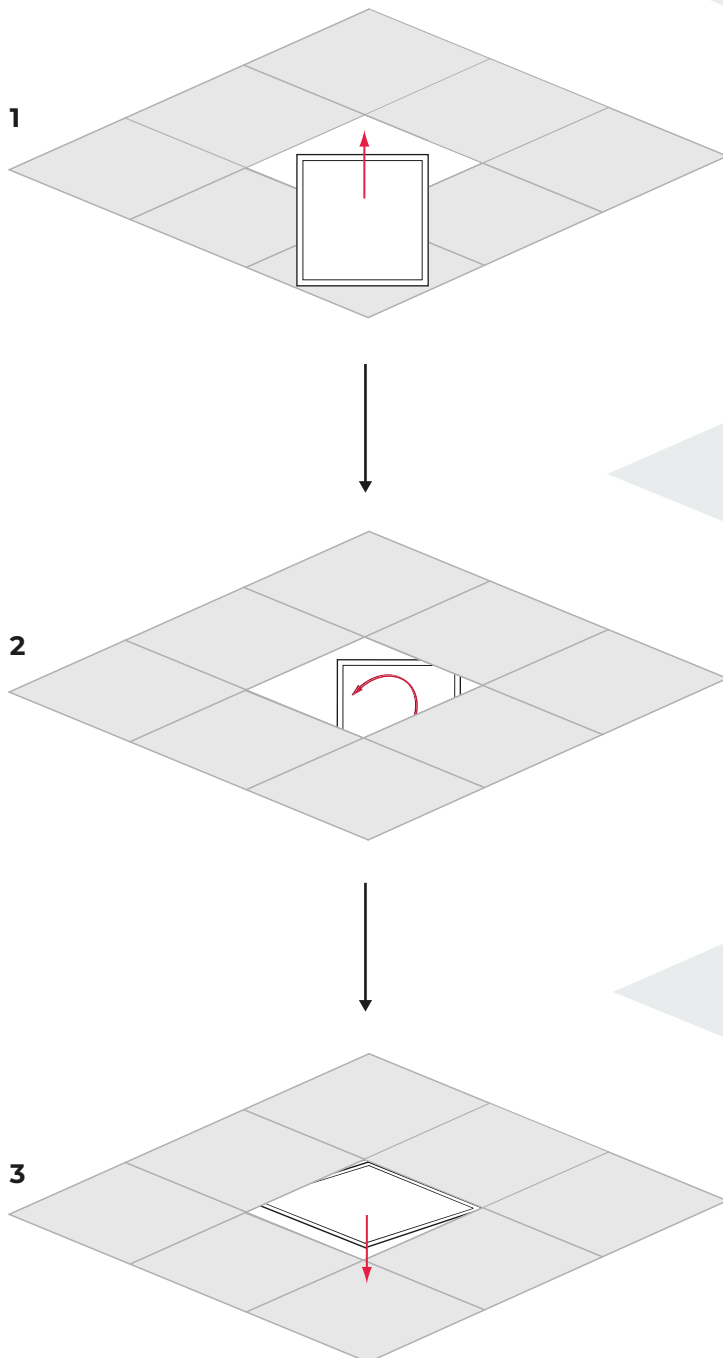

montaż natynkowy

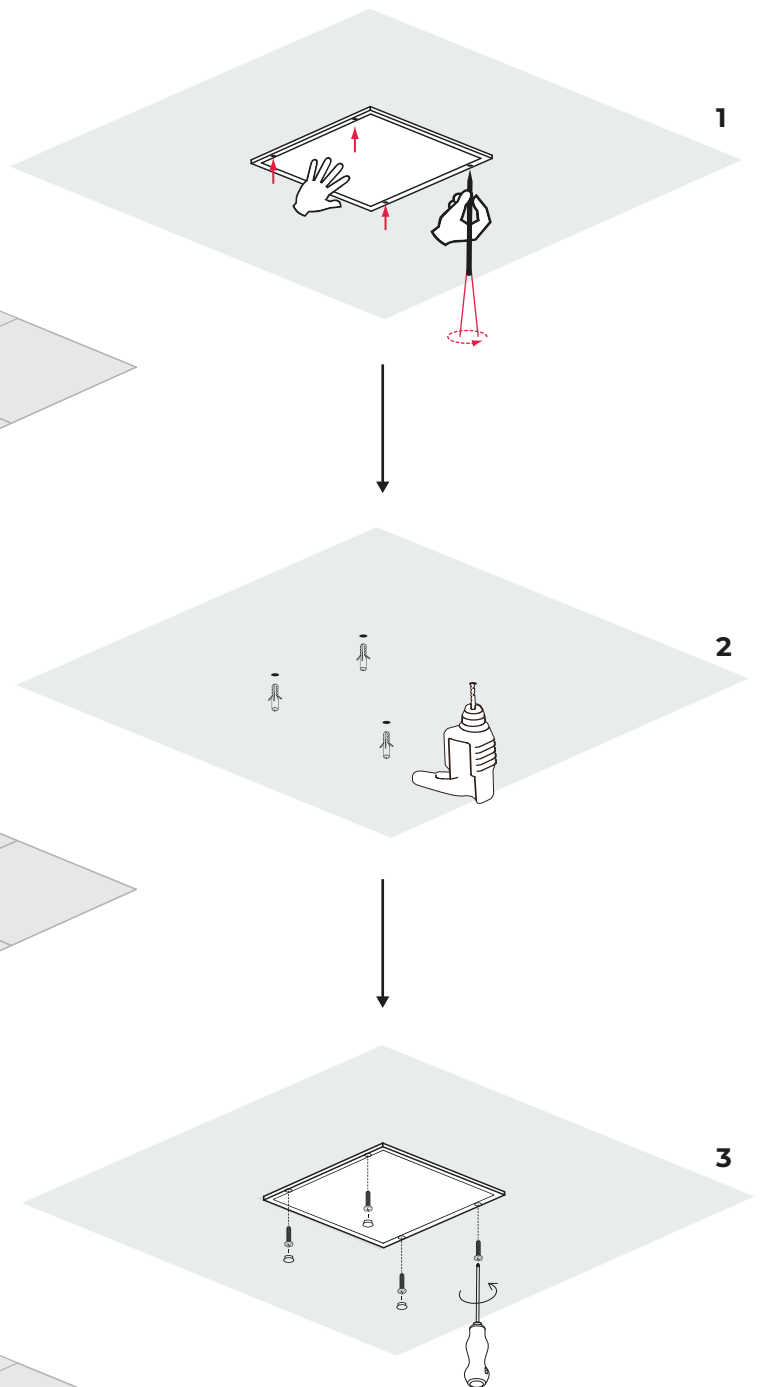

Panel 2in1 30W 3600lm 4000K

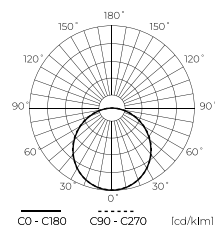
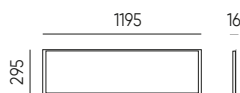
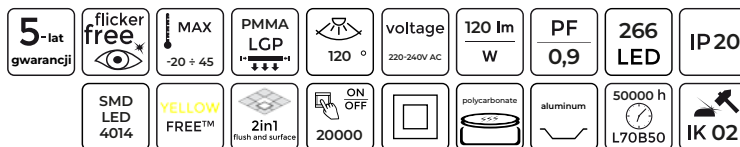

LED line PRIME

SYMBOL	NAZWA	KĄT ŚWIECENIA	MOC	TEMPERATURA BARWOWA	STRUMIEŃ ŚWIETLNY
475459	Panel 2in1 30W 3600lm 4000K 1195x295	120°	30W	4000K	3600lm

Panel 2in1 30W 3600lm 4000K

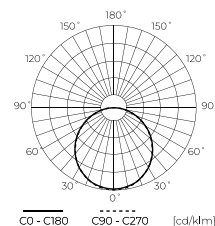
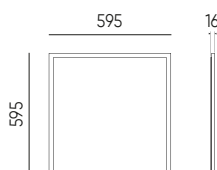
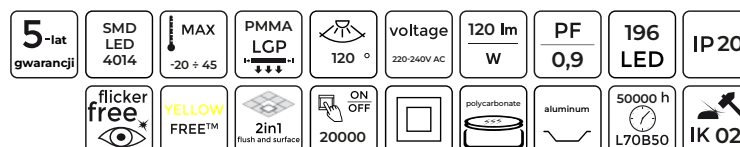

LED line PRIME

SYMBOL	NAZWA	KĄT ŚWIECENIA	MOC	TEMPERATURA BARWOWA	STRUMIEŃ ŚWIETLNY
478481	Panel 2in1 30W 3600lm 4000K 595x595	120°	30W	4000K	3600lm



**Panel Slim 40W 4400lm
4000K UGR<19**

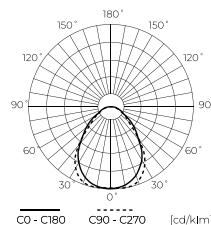
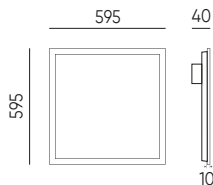
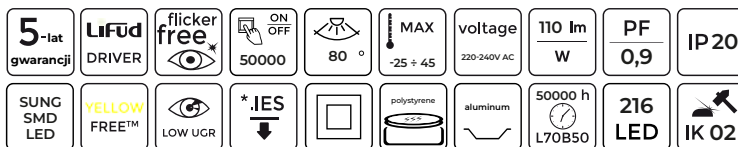

LED line PRIME

SYMBOL	NAZWA	KĄT ŚWIECENIA	MOC	TEMPERATURA BARWOWA	STRUMIEŃ ŚWIETLNY
202474	Panel Slim 40W 4400lm 4000K UGR<19 595x595	80°	40W	4000K	4400lm

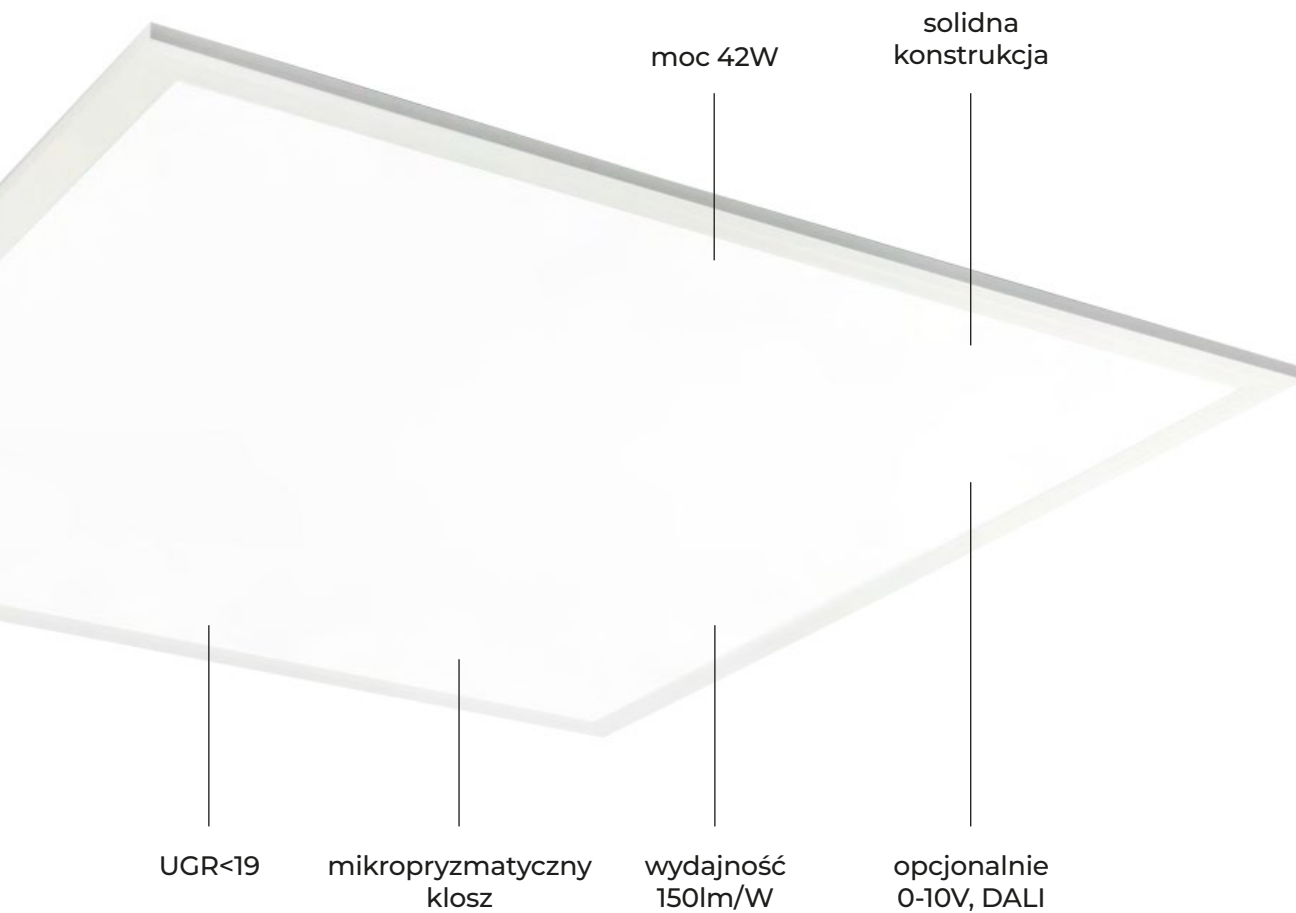

PANEL LED
BACKLIT



Panel Backlit 4000K

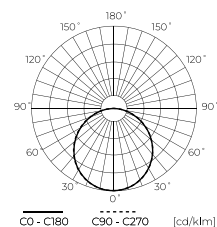
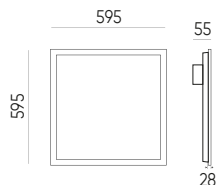
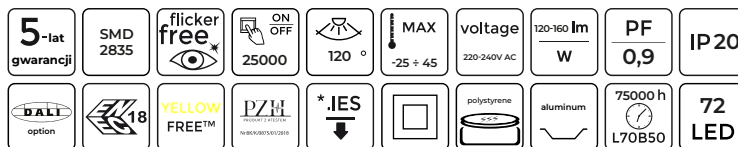

LED line PRIME

205970

205970

SYMBOL	NAZWA	KĄT ŚWIECENIA	MOC	TEMPERATURA BARWOWA	STRUMIEŃ ŚWIETLNY
205970	Panel Backlit 25W 4000lm 4000K 595x595	120°	25W	4000K	4000lm
205987	Panel Backlit 25W 4000lm 4000K 595x595 0-10V	120°	25W	4000K	4000lm
201255	Panel Backlit 28W 4000lm 4000K 595x595	120°	28W	4000K	4000lm
205819	Panel Backlit 34W 4760lm 4000K 595x595	120°	34W	4000K	4760lm
205826	Panel Backlit 34W 4760lm 4000K 595x595 0-10V	120°	34W	4000K	4760lm
200180	Panel Backlit 40W 4800lm 4000K 595x595	120°	40W	4000K	4800lm
201248	Panel Backlit 40W 4800lm 4000K 595x595 0-10V	120°	40W	4000K	4800lm

Panel Backlit 4000K UGR<19

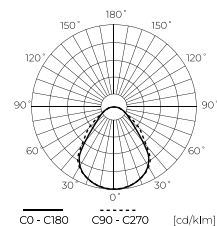
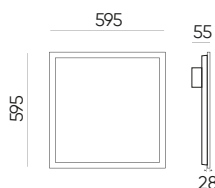
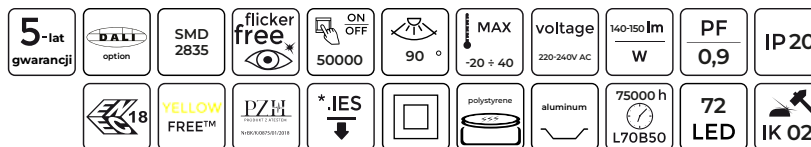

LED line PRIME

205833

205833

SYMBOL	NAZWA	KĄT ŚWIECENIA	MOC	TEMPERATURA BARWOWA	STRUMIEŃ ŚWIETLNY
205833	Panel Backlit 34W 4760lm 4000K UGR<19 595x595	90°	34W	4000K	4760lm
205864	Panel Backlit 34W 4760lm 4000K UGR<19 595x595 0-10V	90°	34W	4000K	4760lm
203457	Panel Backlit 42W 6300lm 4000K UGR<19 595x595	90°	42W	4000K	6300lm

Panel Backlit 40W 4800lm 4000K

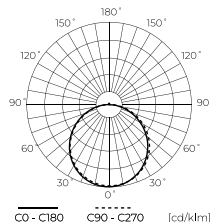
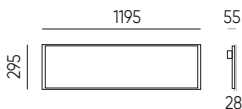
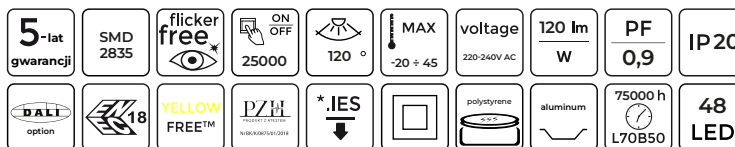

LED line PRIME

SYMBOL	NAZWA	KĄT ŚWIECENIA	MOC	TEMPERATURA BARWOWA	STRUMIEŃ ŚWIETLNY
201330	Panel Backlit 40W 4800lm 4000K 1195x295	120°	40W	4000K	4800lm

Panel Backlit 34W 4760lm 4000K UGR<19

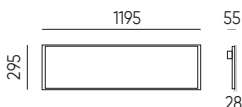
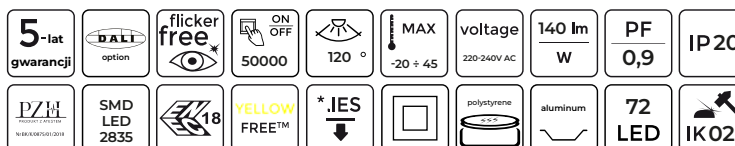

LED line PRIME

SYMBOL	NAZWA	KĄT ŚWIECENIA	MOC	TEMPERATURA BARWOWA	STRUMIEŃ ŚWIETLNY
206519	Panel Backlit 34W 4760lm 4000K UGR<19 1195x295	120°	34W	4000K	4760lm
206526	Panel Backlit 34W 4760lm 4000K UGR<19 1195x295 0-10V	120°	34W	4000K	4760lm

Panel Backlit 34W 4760lm UGR<19

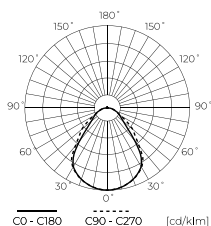
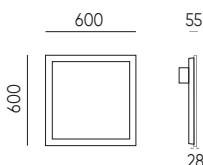
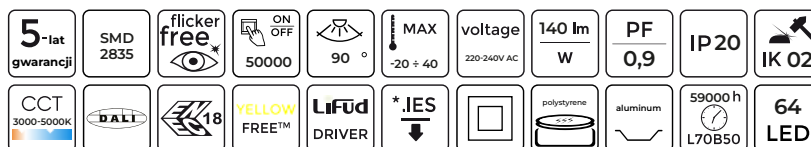

LED line PRIME

SYMBOL	NAZWA	KĄT ŚWIECENIA	MOC	TEMPERATURA BARWOWA	STRUMIEŃ ŚWIETLNY
204522	Panel Backlit 34W 4760lm 4000K UGR<19 620x620	90°	34W	4000K	4760lm
204539	Panel Backlit 34W CCT 4760lm UGR<19 620x620	90°	34W	3000-4000-5000K	4760lm

Panel Backlit 40W 4000lm 4000K

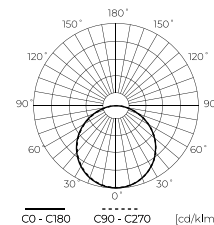
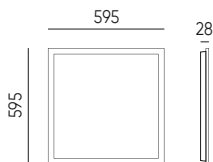

3-lata gwarancji	ON OFF 25000	120°	MAX -25 ÷ 45	voltage 220-240V AC	120 lm W	PF 0,9	IP20	IK 02
SMD LED 2835	flicker free	PZH	*.IES		polystyrene	aluminum	30000 h L70B50	48 LED

LED line LITE

SYMBOL	NAZWA	KĄT ŚWIECENIA	MOC	TEMPERATURA BARWOWA	STRUMIEŃ ŚWIETLNY
202887	Panel Backlit 40W 4000K 4000lm 595x595	120°	40W	4000K	4000lm



PANEL LED
AKCESORIA

**Ramka montażowa
60x60 biała H65mm**

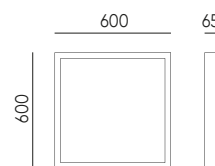

LED line PRIME

SYMBOL	NAZWA	KOMPATYBILNE PRODUKTY	ROZMIAR	KOLOR
203440	Ramka montażowa wys. 65mm 60x60	BACKLIT, SLIM, DIORA	600x600	biały

**Sprężynowe
uchwyty do paneli
Backlit**

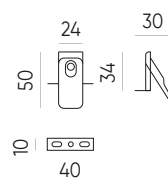

LED line PRIME

SYMBOL	NAZWA	ILOŚĆ
201347	Sprężynowe uchwyty do paneli Backlit	4 szt.

**Sprężyny do paneli
SLIM**

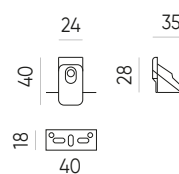

LED line PRIME

SYMBOL	NAZWA	ILOŚĆ
245725	Sprężyny do SLIM Panel, 2in1 Panels, Frame Panel i DIORA	4 szt.

Haczyki do paneli

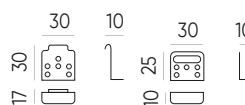

LED line PRIME

SYMBOL	NAZWA	ILOŚĆ
245718	Haczyki do paneli	6 szt.

Stalowe linki

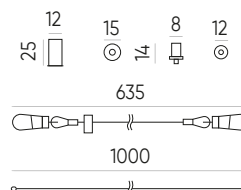

LED line PRIME

SYMBOL	NAZWA	ILOŚĆ
245701	Stalowe linki	100 szt.

wydajność
100lm/W

zasilacz LIFUD
w standardzie

dostępne
warianty
7W, 15W

Dioda COB
bridgelux



alumiowa
obudowa

ukryty
montaż

4 opcje średnicy
montażu

niski UGR<19,
brak odblasków

DOWNLIGHT
QUANTUM

**Downlight QUANTUM 7W
700lm 4000K IP20**

5-lat gwarancji	LiFud DRIVER		88 mm	ON OFF	60°	MAX -5 + 40	voltage AC 220-240	100 lm W	IP20
DIMMABLE	LOW UGR	NARROW BEAM ANGLE	COB	aluminum	polycarbonate	50000 h L70B50	PF 0,8	1 LED	IK 03

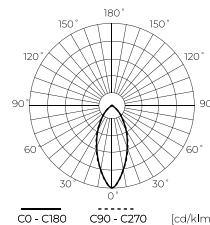
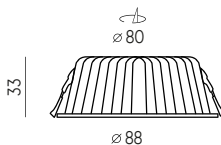

477392

477392

LED line PRIME

SYMBOL	NAZWA	KĄT ŚWIECENIA	MOC	TEMPERATURA BARWOWA	STRUMIEŃ ŚWIETLNY
477392	Downlight QUANTUM 7W 700lm 4000K	60°	7W	4000K	700lm
477477	Downlight QUANTUM 7W 700lm 4000K 1-10V	60°	7W	4000K	700lm

**Downlight QUANTUM 15W
1500lm 4000K IP20**

5-lat gwarancji	LiFud DRIVER		115 mm	ON OFF	60°	MAX -5 + 40	voltage AC 220-240	100 lm W	IP20
DIMMABLE	LOW UGR	NARROW BEAM ANGLE	COB	aluminum	polycarbonate	50000 h L70B50	PF 0,9	1 LED	IK 03

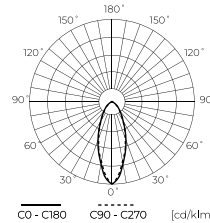
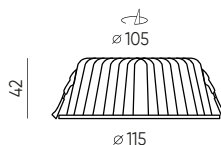

477408

477408

LED line PRIME

SYMBOL	NAZWA	KĄT ŚWIECENIA	MOC	TEMPERATURA BARWOWA	STRUMIEŃ ŚWIETLNY
477408	Downlight QUANTUM 15W 1500lm 4000K	60°	15W	4000K	1500lm
477484	Downlight QUANTUM 15W 1500lm 4000K 1-10V	60°	15W	4000K	1500lm



DOWNLIGHT
CALMOS

Downlight CALMOS 18W
2100lm 4000K IP44

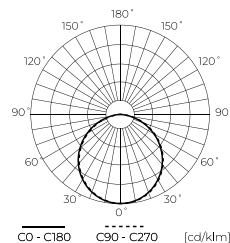
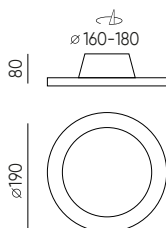
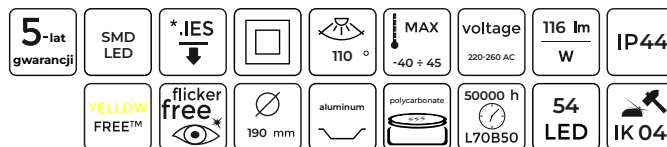

LED line PRIME

SYMBOL	NAZWA	KĄT ŚWIECENIA	MOC	TEMPERATURA BARWOWA	STRUMIEŃ ŚWIETLNY
202122	Downlight CALMOS 18W 2100lm 4000K IP44	110°	18W	4000K	2100lm

Downlight CALMOS 24W
2800lm 4000K IP44

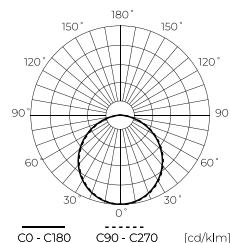
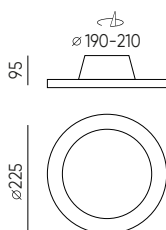
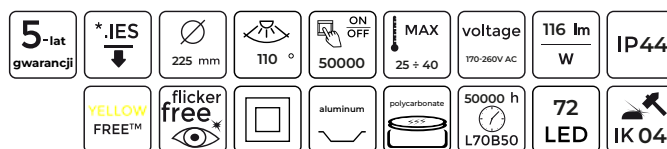

LED line PRIME

SYMBOL	NAZWA	KĄT ŚWIECENIA	MOC	TEMPERATURA BARWOWA	STRUMIEŃ ŚWIETLNY
202139	Downlight CALMOS 24W 2800lm 4000K IP44	110°	24W	4000K	2800lm



wydajność
100lm/W

moc
6 - 24W

bez efektu
migotania

wersja CCT
3000-4000-5000K

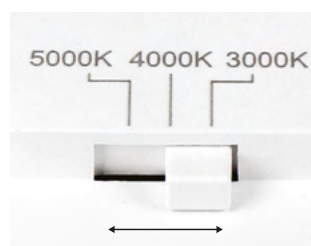

DOWNLIGHT
EASY FIX PRO



łatwa instalacja
regulowany wspornik

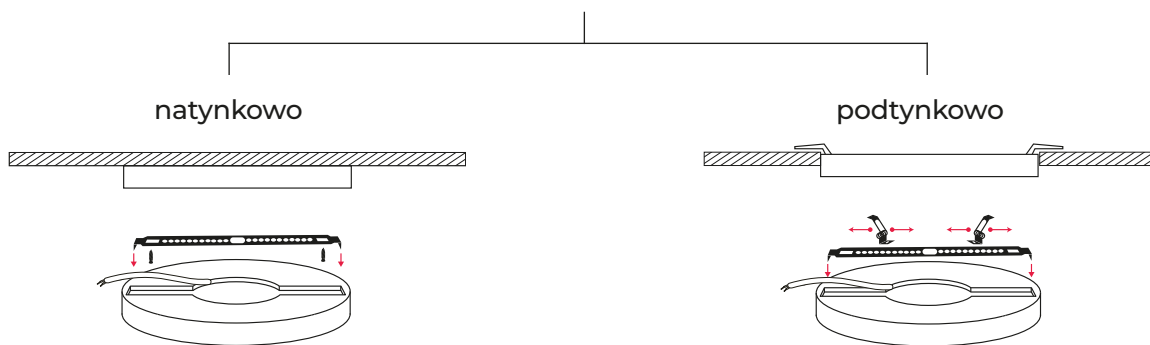

Downlight EASY FIX PRO 6W CCT

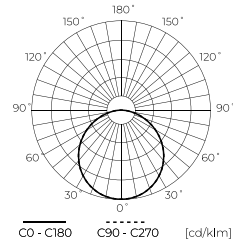
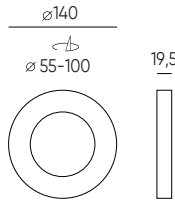
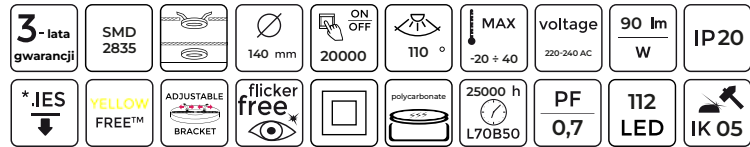

LED line LITE

SYMBOL	NAZWA	KĄT ŚWIECENIA	MOC	TEMPERATURA BARWOWA	STRUMIEŃ ŚWIETLNY
202825	Downlight EASY FIX PRO 6W 540lm CCT okrągły	110°	6W	3000-4000-5000K	540lm

Downlight EASY FIX PRO 12W CCT

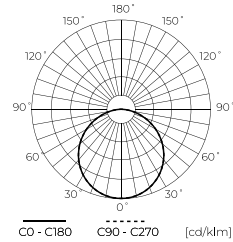
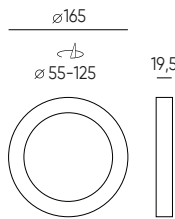
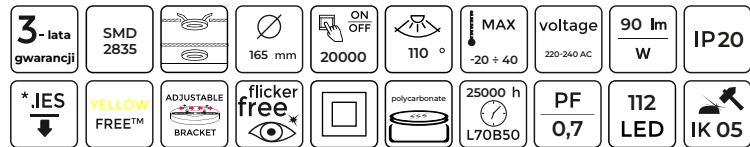

LED line LITE

SYMBOL	NAZWA	KĄT ŚWIECENIA	MOC	TEMPERATURA BARWOWA	STRUMIEŃ ŚWIETLNY
202832	Downlight EASY FIX PRO 12W 1080lm CCT okrągły	110°	12W	3000-4000-5000K	1080lm

Downlight EASY FIX PRO 18W CCT

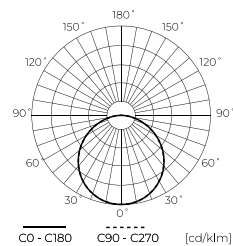
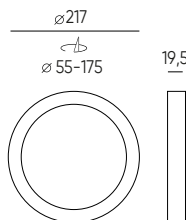
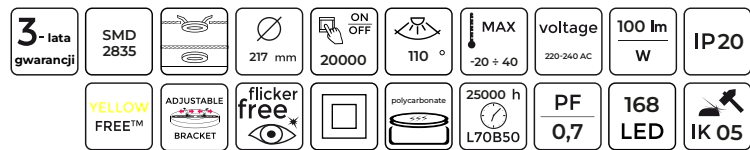

LED line LITE

SYMBOL	NAZWA	KĄT ŚWIECENIA	MOC	TEMPERATURA BARWOWA	STRUMIEŃ ŚWIETLNY
202849	Downlight EASY FIX PRO 18W 1800lm CCT okrągły	110°	18W	3000-4000-5000K	1800lm

Downlight EASY FIX PRO 24W CCT

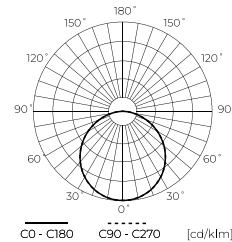
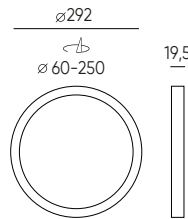
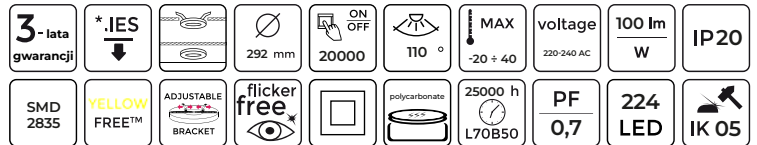

LED line LITE

SYMBOL	NAZWA	KĄT ŚWIECENIA	MOC	TEMPERATURA BARWOWA	STRUMIEŃ ŚWIETLNY
202856	Downlight EASY FIX PRO 24W 2400lm CCT okrągły	110°	24W	3000-4000-5000K	2400lm

Downlight EASY FIX PRO 18W CCT

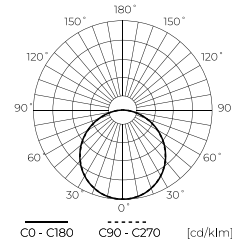
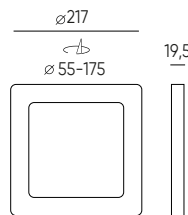
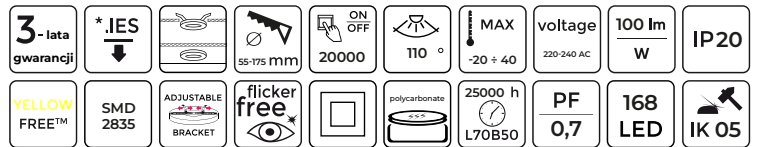

LED line LITE

SYMBOL	NAZWA	KĄT ŚWIECENIA	MOC	TEMPERATURA BARWOWA	STRUMIEŃ ŚWIETLNY
202863	Downlight EASY FIX PRO 18W 1800lm CCT kwadratowy	110°	18W	3000-4000-5000K	1800lm

Downlight EASY FIX PRO 24W CCT

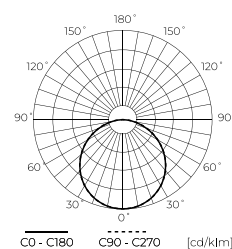
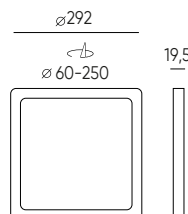
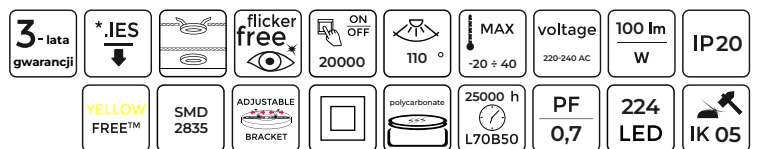

LED line LITE

SYMBOL	NAZWA	KĄT ŚWIECENIA	MOC	TEMPERATURA BARWOWA	STRUMIEŃ ŚWIETLNY
202870	Downlight EASY FIX PRO 24W 2400lm CCT kwadratowy	110°	24W	3000-4000-5000K	2400lm



DOWNLIGHT
EASY FIX

Downlight EASY FIX 6W

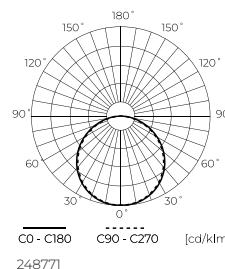
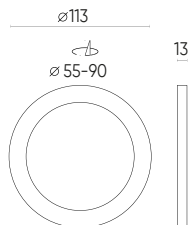
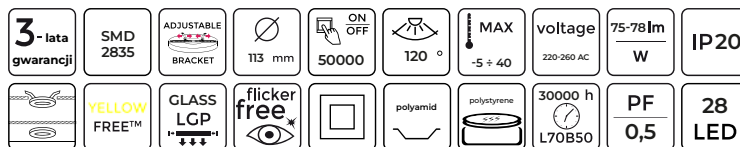

LED line LITE

SYMBOL	NAZWA	KĄT ŚWIECENIA	MOC	TEMPERATURA BARWOWA	STRUMIEŃ ŚWIETLNY
248771	Downlight EASY FIX 6W 450lm 2700K okrągły	120°	6W	2700K	450lm
248788	Downlight EASY FIX 6W 470lm 4000K okrągły	120°	6W	4000K	470lm

Downlight EASY FIX 18W

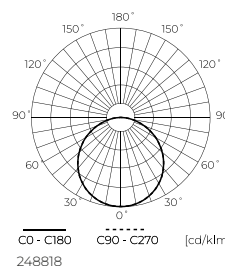
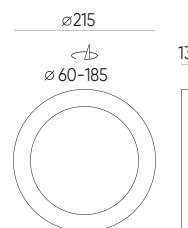
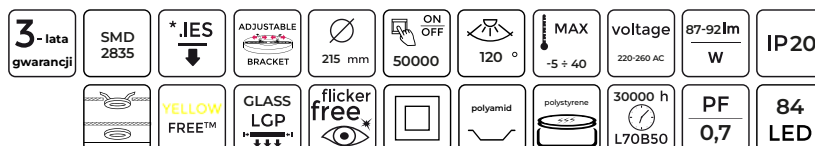

LED line LITE

SYMBOL	NAZWA	KĄT ŚWIECENIA	MOC	TEMPERATURA BARWOWA	STRUMIEŃ ŚWIETLNY
248818	Downlight EASY FIX 18W 1570lm 2700K okrągły	120°	18W	2700K	1570lm
248825	Downlight EASY FIX 18W 1650lm 4000K okrągły	120°	18W	4000K	1650lm

Downlight EASY FIX 24W

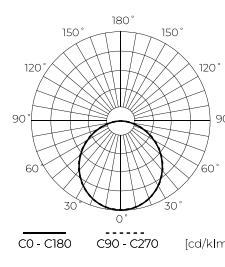
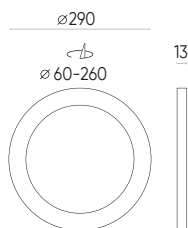
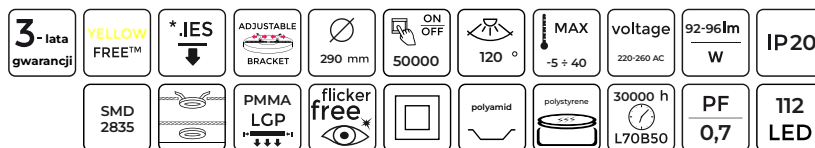

LED line LITE

SYMBOL	NAZWA	KĄT ŚWIECENIA	MOC	TEMPERATURA BARWOWA	STRUMIEŃ ŚWIETLNY
248832	Downlight EASY FIX 24W 2200lm 2700K okrągły	120°	24W	2700K	2200lm
248849	Downlight EASY FIX 24W 2300lm 4000K okrągły	120°	24W	4000K	2300lm

Downlight EASY FIX 6W

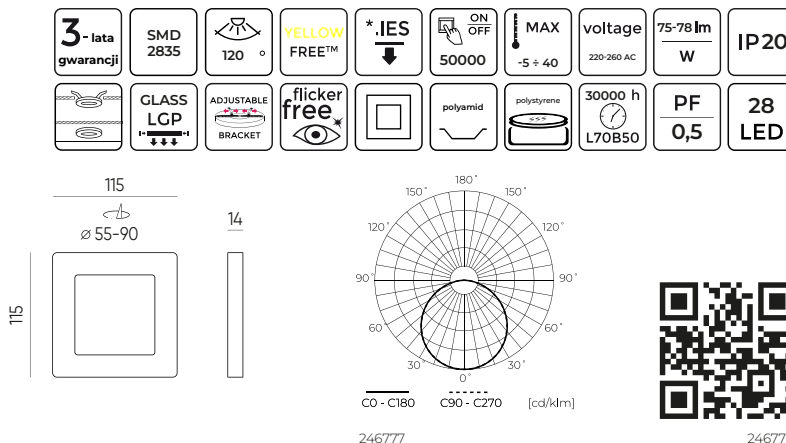

LED line LITE

SYMBOL	NAZWA	KĄT ŚWIECENIA	MOC	TEMPERATURA BARWOWA	STRUMIEŃ ŚWIETLNY
246777	Downlight EASY FIX 6W 450lm 2700K kwadratowy	120°	6W	2700K	450lm
246784	Downlight EASY FIX 6W 470lm 4000K kwadratowy	120°	6W	4000K	470lm

Downlight EASY FIX 12W

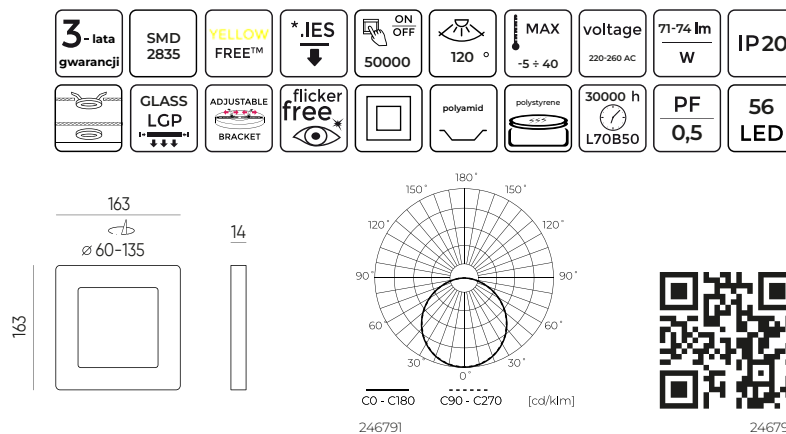

LED line LITE

SYMBOL	NAZWA	KĄT ŚWIECENIA	MOC	TEMPERATURA BARWOWA	STRUMIEŃ ŚWIETLNY
246791	Downlight EASY FIX 12W 850lm 2700K kwadratowy	120°	12W	2700K	850lm
246890	Downlight EASY FIX 12W 890lm 4000K kwadratowy	120°	12W	4000K	890lm

Downlight EASY FIX 18W

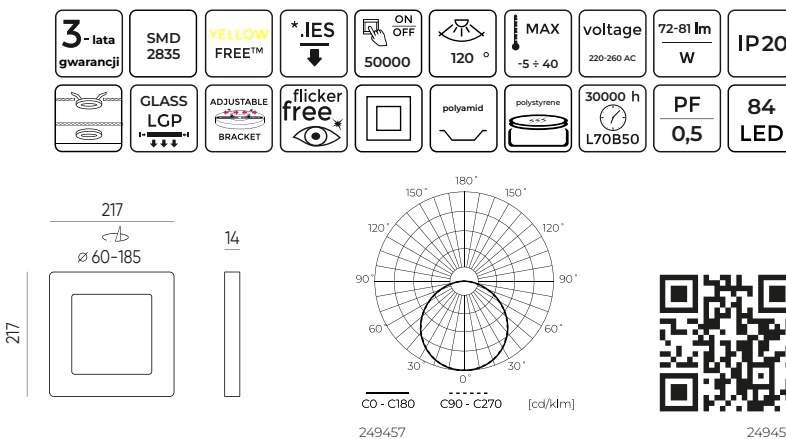

LED line LITE

SYMBOL	NAZWA	KĄT ŚWIECENIA	MOC	TEMPERATURA BARWOWA	STRUMIEŃ ŚWIETLNY
249457	Downlight EASY FIX 18W 1300lm 2700K kwadratowy	120°	18W	2700K	1300lm
249464	Downlight EASY FIX 18W 1450lm 4000K kwadratowy	120°	18W	4000K	1450lm

Downlight EASY FIX 24W

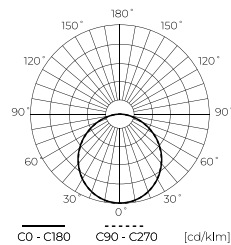
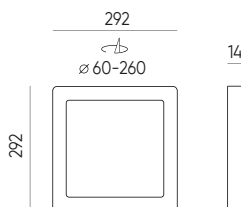
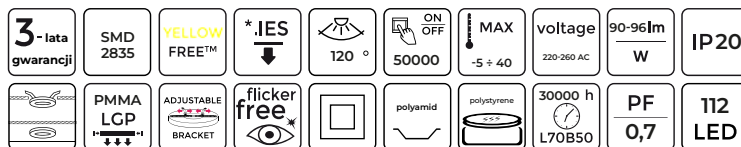

249471

249471

LED line LITE

SYMBOL	NAZWA	KĄT ŚWIECENIA	MOC	TEMPERATURA BARWOWA	STRUMIEŃ ŚWIETLNY
249471	Downlight EASY FIX 24W 2150lm 2700K kwadratowy	120°	24W	2700K	2150lm
249488	Downlight EASY FIX 24W 2300lm 4000K kwadratowy	120°	24W	4000K	2300lm



wersje
3000K,
4000K

odporny na
żółknięcie

bez efektu
migotania



wersja
z czujnikiem
ruchu

klosz
z poliwęglanu

moc
5W-24W



dwie wersje
montażu w jednej
oprawie:

natynkowo

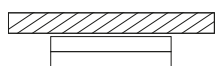

podtynkowo



wersja CCT
3000K
4000K
6000K



32 modele
okrągłe
i kwadratowe

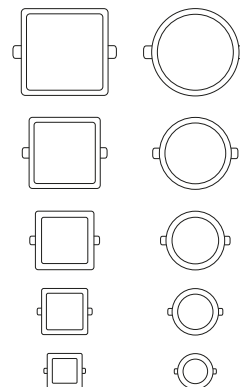

DOWNLIGHT MOLLY

Downlight MOLLY 5W

3-lata gwarancji	*.IES ↓	110°	ON OFF 20000	MAX -20 + 40	30000 h L70B50	voltage 220-240 AC	90-100 lm W	IP20
SMD 2835	YELLOW FREE™	flicker free™	95 mm	Polycarbonate	PF 0,5	16 LED		

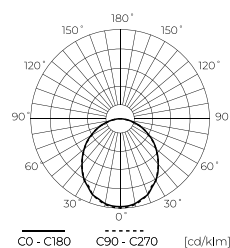
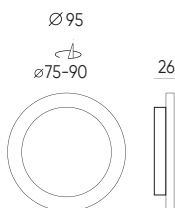

LED line LITE

SYMBOL	NAZWA	KĄT ŚWIECENIA	MOC	TEMPERATURA BARWOWA	STRUMIEŃ ŚWIETLNY
200739	Downlight MOLLY 5W 450lm 3000K okrągły	110°	5W	3000K	450lm
200746	Downlight MOLLY 5W 500lm 4000K okrągły	110°	5W	4000K	500lm

Downlight MOLLY 9W

3-lata gwarancji	*.IES ↓	110°	ON OFF 20000	MAX -20 + 40	30000 h L70B50	voltage 170-260V AC	90-100 lm W	IP20
SMD 2835	YELLOW FREE™	flicker free™	120 mm	Polycarbonate	PF 0,5	30 LED		

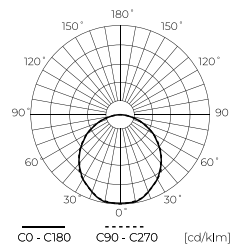
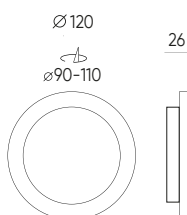

LED line LITE

SYMBOL	NAZWA	KĄT ŚWIECENIA	MOC	TEMPERATURA BARWOWA	STRUMIEŃ ŚWIETLNY
200753	Downlight MOLLY 9W 830lm 3000K okrągły	110°	9W	3000K	830lm
200760	Downlight MOLLY 9W 900lm 4000K okrągły	110°	9W	4000K	900lm

Downlight MOLLY 12W

3-lata gwarancji	*.IES ↓	110°	ON OFF 20000	MAX -20 + 40	30000 h L70B50	voltage 170-260V AC	95-105 lm W	IP20
SMD 2835	YELLOW FREE™	flicker free™	120 mm	Polycarbonate	PF 0,5	45 LED		

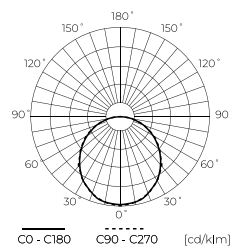
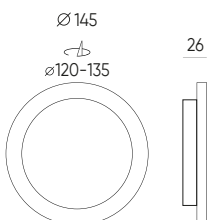

LED line LITE

SYMBOL	NAZWA	KĄT ŚWIECENIA	MOC	TEMPERATURA BARWOWA	STRUMIEŃ ŚWIETLNY
200777	Downlight MOLLY 12W 1150lm 3000K okrągły	110°	12W	3000K	1150lm
200784	Downlight MOLLY 12W 1250lm 4000K okrągły	110°	12W	4000K	1250lm

Downlight MOLLY 18W

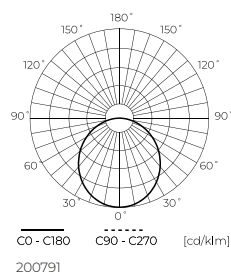
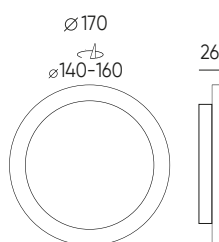
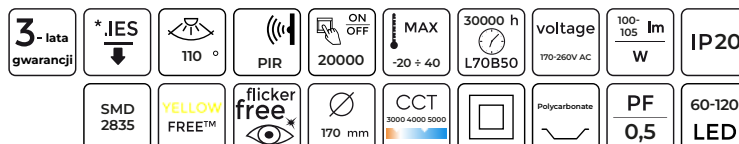

200791

LED line LITE

SYMBOL	NAZWA	KĄT ŚWIECENIA	MOC	TEMPERATURA BARWOWA	STRUMIEŃ ŚWIETLNY
200791	Downlight MOLLY 18W 1750lm 3000K okrągły	110°	18W	3000K	1750lm
200807	Downlight MOLLY 18W 1900lm 4000K okrągły	110°	18W	4000K	1900lm
200999	Downlight MOLLY 18W 1900lm CCT 3000-4000-6000K okrągły	110°	18W	3000-4000-6000K	1900lm
201019	Downlight MOLLY 18W 1900lm 4000K okrągły z czujnikiem ruchu	110°	18W	4000K	1900lm

Downlight MOLLY 24W

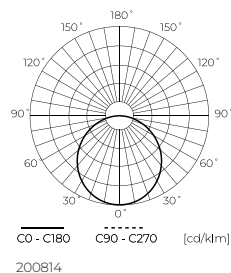
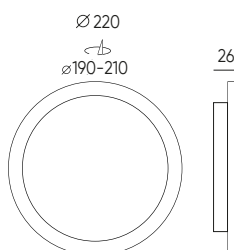
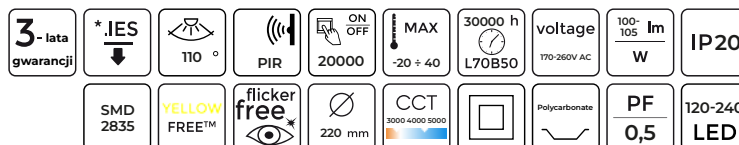

200814

LED line LITE

SYMBOL	NAZWA	KĄT ŚWIECENIA	MOC	TEMPERATURA BARWOWA	STRUMIEŃ ŚWIETLNY
200814	Downlight MOLLY 24W 2350lm 3000K okrągły	110°	24W	3000K	2350lm
200821	Downlight MOLLY 24W 2550lm 4000K okrągły	110°	24W	4000K	2550lm
201002	Downlight MOLLY 24W 2550lm CCT 3000-4000-6000K okrągły	110°	24W	3000-4000-6000K	2550lm
201026	Downlight MOLLY 24W 2550lm 4000K okrągły z czujnikiem ruchu	110°	24W	4000K	2550lm

Downlight MOLLY 5W

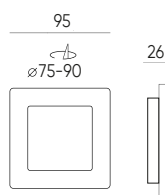

3-lata gwarancji	*.IES ↓	ON OFF 20000	MAX -20 ÷ 40	30000 h L70B50	voltage 220-240V AC	90-100lm W	IP20
SMD 2835	YELLOW FREE™	flicker free			Polycarbonate	PF 0,5	30 LED

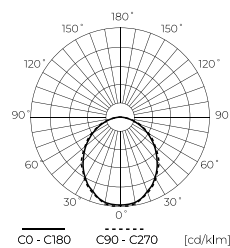

201033

201033

LED line LITE

SYMBOL	NAZWA	KĄT ŚWIECENIA	MOC	TEMPERATURA BARWOWA	STRUMIEŃ ŚWIETLNY
201033	Downlight MOLLY 5W 450lm 3000K kwadratowy	110°	5W	3000K	450lm
201040	Downlight MOLLY 5W 500lm 4000K kwadratowy	110°	5W	4000K	500lm

Downlight MOLLY 9W

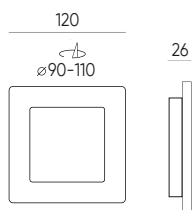

3-lata gwarancji	SMD 2835	ON OFF 20000	MAX -20 ÷ 40	30000 h L70B50	voltage 170-260V AC	90-100lm W	IP20
YELLOW FREE™	flicker free				Polycarbonate	PF 0,5	30 LED

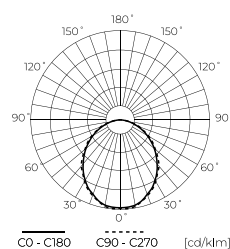

200838

200838

LED line LITE

SYMBOL	NAZWA	KĄT ŚWIECENIA	MOC	TEMPERATURA BARWOWA	STRUMIEŃ ŚWIETLNY
200838	Downlight MOLLY 9W 830lm 3000K kwadratowy	110°	9W	3000K	830lm
200845	Downlight MOLLY 9W 900lm 4000K kwadratowy	110°	9W	4000K	900lm

Downlight MOLLY 12W

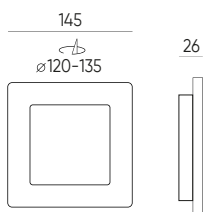

3-lata gwarancji	*.IES ↓	ON OFF 20000	MAX -20 ÷ 40	30000 h L70B50	voltage 170-260V AC	95-105lm W	IP20
SMD 2835	YELLOW FREE™	flicker free			Polycarbonate	PF 0,5	56 LED

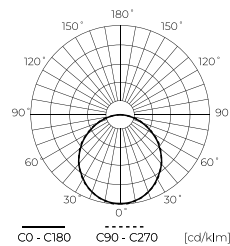

200852

200852

LED line LITE

SYMBOL	NAZWA	KĄT ŚWIECENIA	MOC	TEMPERATURA BARWOWA	STRUMIEŃ ŚWIETLNY
200852	Downlight MOLLY 12W 1150lm 3000K kwadratowy	110°	12W	3000K	1150lm
200869	Downlight MOLLY 12W 1250lm 4000K kwadratowy	110°	12W	4000K	1250lm

Downlight MOLLY 18W

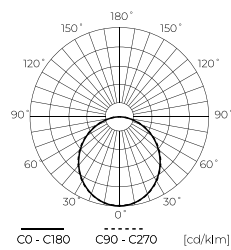
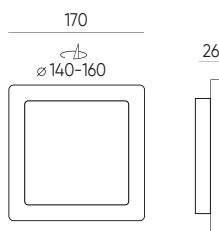
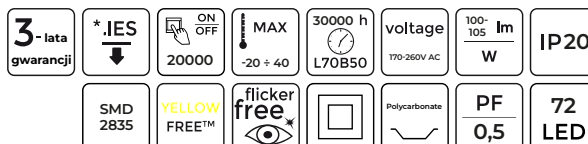

200876

200876

LED line LITE

SYMBOL	NAZWA	KĄT ŚWIECENIA	MOC	TEMPERATURA BARWOWA	STRUMIEŃ ŚWIETLNY
200876	Downlight MOLLY 18W 1750lm 3000K kwadratowy	110°	18W	3000K	1750lm
200883	Downlight MOLLY 18W 1900lm 4000K kwadratowy	110°	18W	4000K	1900lm

Downlight MOLLY 24W

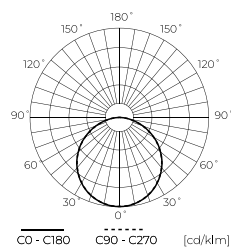
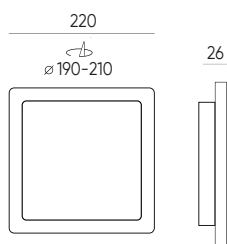
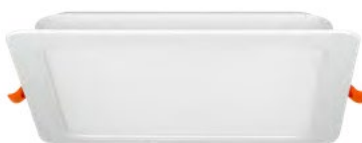
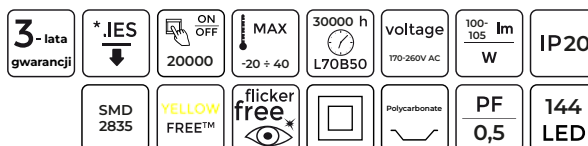

200890

200890

LED line LITE

SYMBOL	NAZWA	KĄT ŚWIECENIA	MOC	TEMPERATURA BARWOWA	STRUMIEŃ ŚWIETLNY
200890	Downlight MOLLY 24W 2550lm 3000K kwadratowy	110°	24W	3000K	2350lm
200906	Downlight MOLLY 24W 2550lm 4000K kwadratowy	110°	24W	4000K	2550lm

Ramka do montażu natynkowego Downlight MOLLY okrągła



LED line LITE

200913

SYMBOL	NAZWA
200913	Ramka do montażu natynkowego Downlight MOLLY 9W okrągła
200920	Ramka do montażu natynkowego Downlight MOLLY 12W okrągła
200937	Ramka do montażu natynkowego Downlight MOLLY 18W okrągła
200944	Ramka do montażu natynkowego Downlight MOLLY 24W okrągła

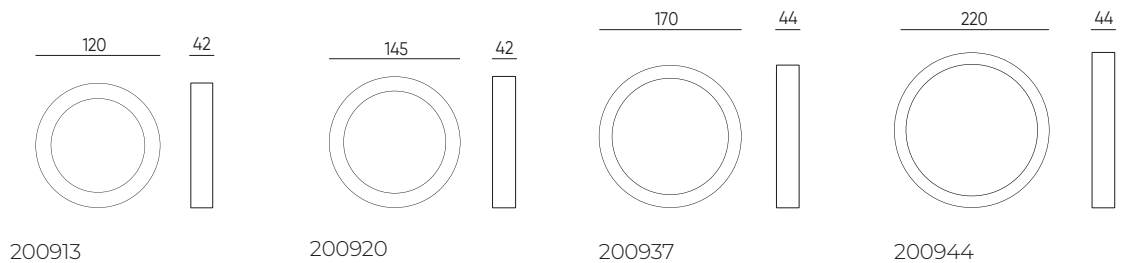

Ramka do montażu natynkowego Downlight MOLLY kwadratowy



LED line LITE

200951

SYMBOL	NAZWA
200951	Ramka do montażu natynkowego Downlight MOLLY 9W kwadratowa
200968	Ramka do montażu natynkowego Downlight MOLLY 12W kwadratowa
200975	Ramka do montażu natynkowego Downlight MOLLY 18W kwadratowa
200982	Ramka do montażu natynkowego Downlight MOLLY 24W kwadratowa

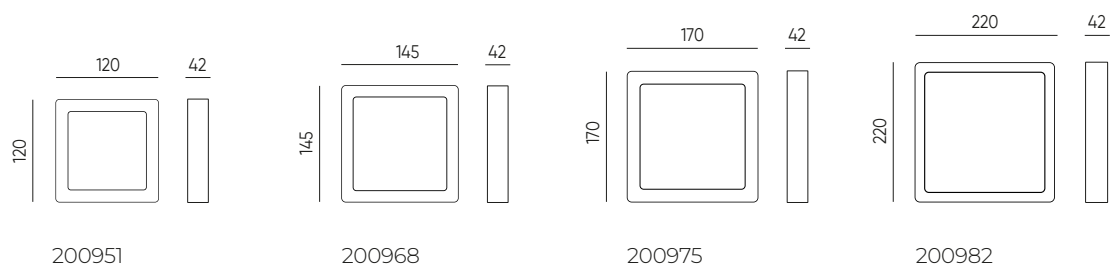

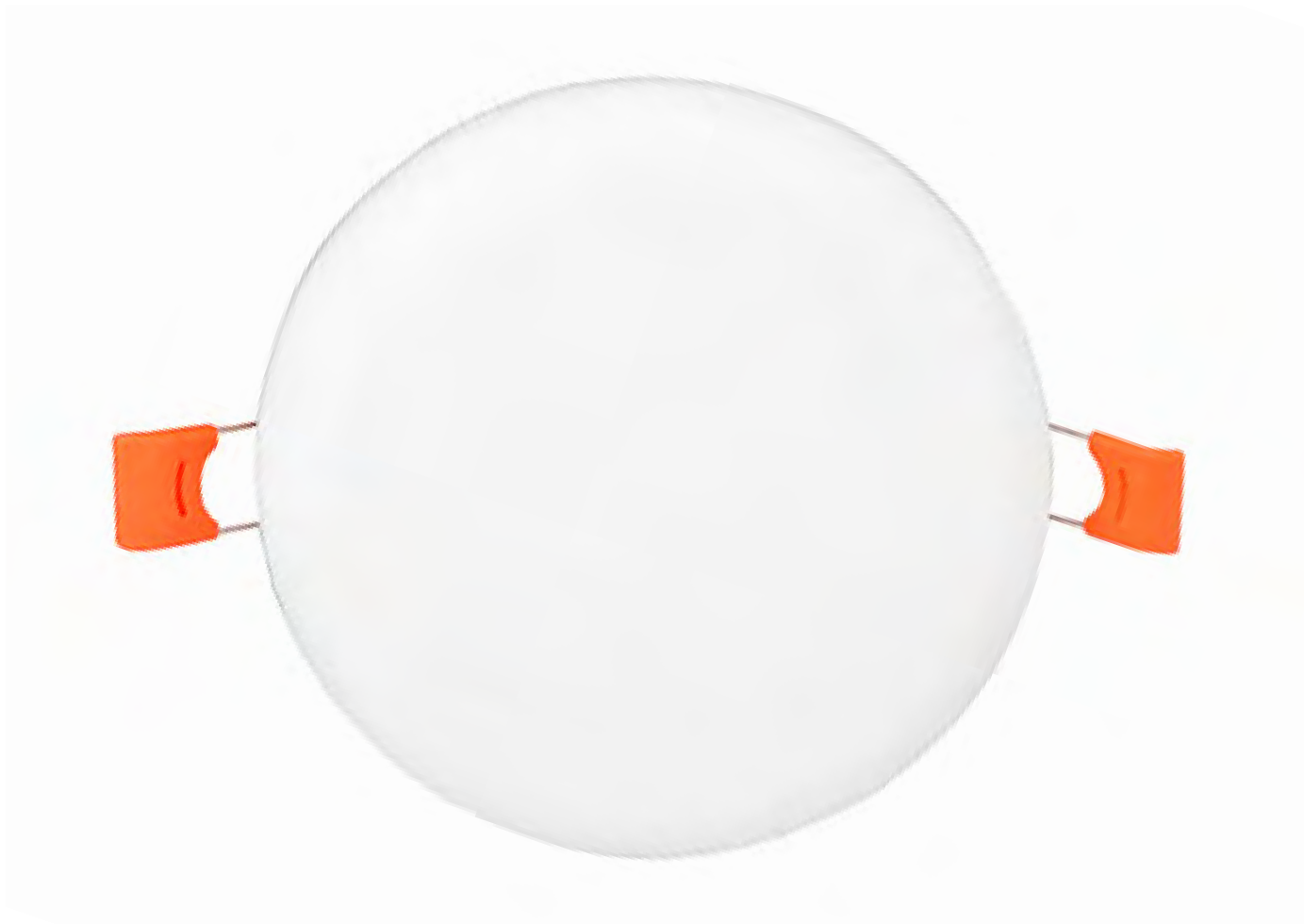

DOWNLIGHT
FRAMELESS

Downlight FRAMELESS 8W 800lm

2-lata gwarancji	SMD 2835	ON OFF 50000	MAX -5 ÷ 40	90 mm	voltage 220-240V AC	100 lm W	IP20
30000 h L70B50		180°	polycarbonate	aluminum	PF 0,9	45 LED	

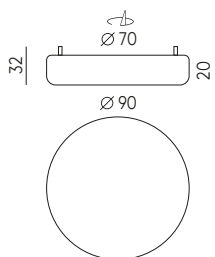

470614

LED line LITE

SYMBOL	NAZWA	KĄT ŚWIECENIA	MOC	TEMPERATURA BARWOWA	STRUMIEŃ ŚWIETLNY
470614	Downlight FRAMELESS panel 8W 800lm 2700K	180°	8W	2700K	800lm
470621	Downlight FRAMELESS panel 8W 800lm 4000K	180°	8W	4000K	800lm

Downlight FRAMELESS 18W 1800lm

2-lata gwarancji	SMD 2835	ON OFF 50000	MAX -5 ÷ 40	120 mm	voltage 220-240V AC	100 lm W	IP20
30000 h L70B50		180°	polycarbonate	aluminum	PF 0,9	90 LED	

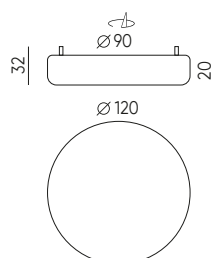

470638

LED line LITE

SYMBOL	NAZWA	KĄT ŚWIECENIA	MOC	TEMPERATURA BARWOWA	STRUMIEŃ ŚWIETLNY
470638	Downlight FRAMELESS 18W 1800lm 2700K	180°	18W	2700K	1800lm
470645	Downlight FRAMELESS 18W 1800lm 4000K	180°	18W	4000K	1800lm



OPRAWKA SUFITOWA
PIPE

Oprawa do szynoprzewodu jednofazowego GU10 PIPE

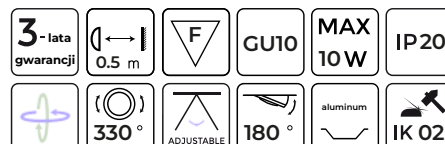
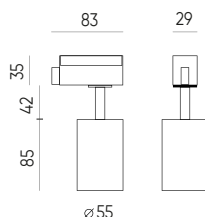

LED line LITE

478252

SYMBOL	NAZWA	KSZTAŁT	TYP MONTAŻU	CECHA	MATERIAŁ
478252	Oprawa do szynoprzewodu jednofazowego GU10 czarna PIPE	okrągły	szyna	regulowany	aluminium
475442	Oprawa do szynoprzewodu jednofazowego GU10 biała PIPE	okrągły	szyna	regulowany	aluminium

Oprawa natynkowa GU10 PIPE

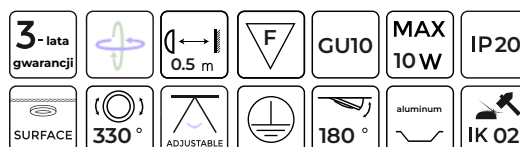
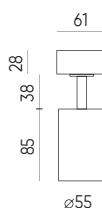

LED line LITE

478276

SYMBOL	NAZWA	KSZTAŁT	TYP MONTAŻU	CECHA	MATERIAŁ
478276	Oprawa natynkowa GU10 czarna PIPE	okrągły	natynkowo	regulowany	aluminium
478283	Oprawa natynkowa GU10 biała PIPE	okrągły	natynkowo	regulowany	aluminium

Oprawa zwieszana GU10 czarny PIPE

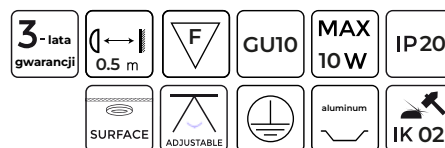
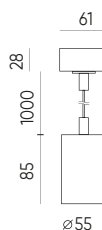
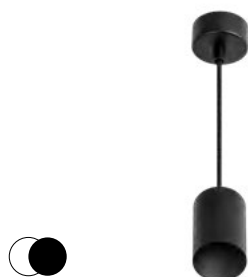

LED line LITE

478290

SYMBOL	NAZWA	KSZTAŁT	TYP MONTAŻU	MATERIAŁ
478290	Oprawa zwieszana GU10 czarna PIPE	okrągły	zwieszany	aluminium
478306	Oprawa zwieszana GU10 biała PIPE	okrągły	zwieszany	aluminium

wysoka
wydajność
do 140lm/W

szklany
klosz



ceramiczna
obudowa

doskonałe
odprowadzanie
ciepła

ŹRÓDŁO ŚWIATŁA LED CERAMIC



E27



E14



GU10



GU11



MR16

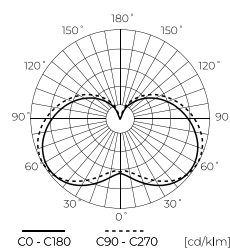
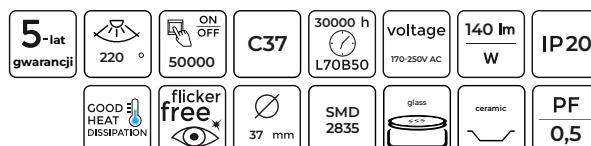

MR11

**Źródło światła LED CERAMIC E14
 5W 700lm C37**

201606

201606

LED line PRIME

SYMBOL	NAZWA	KĄT ŚWIECENIA	MOC	TEMPERATURA BARWOWA	STRUMIEŃ ŚWIETLNY	TYP	MATERIAŁ
201606	Źródło światła LED E14 5W 700lm 2700K 170-250V C37 ŚWIECZKA	220°	5W	2700K	700lm	E14	ceramika
201613	Źródło światła LED E14 5W 700lm 4000K 170-250V C37 ŚWIECZKA	220°	5W	4000K	700lm	E14	ceramika
201620	Źródło światła LED E14 5W 700lm 6500K 170-250V C37 ŚWIECZKA	220°	5W	6500K	700lm	E14	ceramika

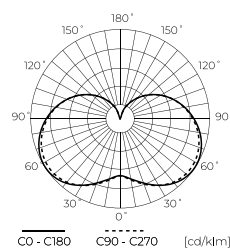
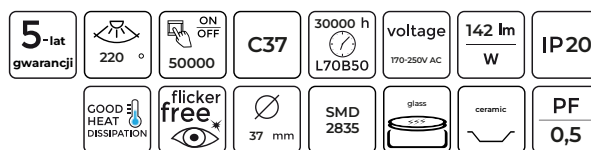
**Źródło światła LED CERAMIC E14
 7W 1000lm C37**

247576-II

247576-II

LED line PRIME

SYMBOL	NAZWA	KĄT ŚWIECENIA	MOC	TEMPERATURA BARWOWA	STRUMIEŃ ŚWIETLNY	TYP	MATERIAŁ
247576-II	Źródło światła LED E14 7W 1000lm 2700K 170-250V C37 ŚWIECZKA	220°	7W	2700K	1000lm	E14	ceramika
247583-II	Źródło światła LED E14 7W 1000lm 4000K 170-250V C37 ŚWIECZKA	220°	7W	4000K	1000lm	E14	ceramika
201651	Źródło światła LED E14 7W 1000lm 6500K 170-250V C37 ŚWIECZKA	220°	7W	6500K	1000lm	E14	ceramika

Źródło światła LED CERAMIC E14 9W 1260lm C37



5-lat gwarancji	220°	ON OFF 50000	C37	30000 h L70B50	voltage 170-250V AC	140 lm W	IP20
SMD 2835	GOOD HEAT DISSIPATION	flicker free	37 mm	SMD 2835	glass	ceramic	PF 0,5

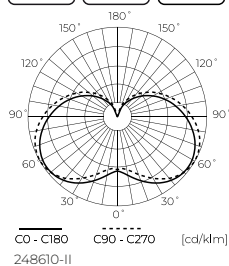

248610-II

LED line PRIME

SYMBOL	NAZWA	KĄT ŚWIECENIA	MOC	TEMPERATURA BARWOWA	STRUMIEŃ ŚWIETLNY	TYP	MATERIAŁ
248610-II	Źródło światła LED E14 9W 1260lm 2700K 170-250V C37 ŚWIECZKA	220°	9W	2700K	1260lm	E14	ceramika
248627-II	Źródło światła LED E14 9W 1260lm 4000K 170-250V C37 ŚWIECZKA	220°	9W	4000K	1260lm	E14	ceramika
201682	Źródło światła LED E14 9W 1260lm 6500K 170-250V C37 ŚWIECZKA	220°	9W	6500K	1260lm	E14	ceramika

Źródło światła LED CERAMIC E14 9W 1170lm C37 DIMMABLE



5-lat gwarancji	C37	220°	ON OFF 50000	30000 h L70B50	voltage 170-250V AC	130 lm W	IP20
GOOD HEAT DISSIPATION	TRIAC	35 mm	SMD 2835	glass	ceramic	PF 0,7	

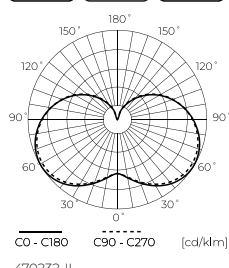

470232-II

LED line PRIME

SYMBOL	NAZWA	KĄT ŚWIECENIA	MOC	TEMPERATURA BARWOWA	STRUMIEŃ ŚWIETLNY	TYP	MATERIAŁ
470232-II	Źródło światła LED E14 9W 1170lm 2700K 170-250V C37 DIM	220°	9W	2700K	1170lm	E14	ceramika
470249-II	Źródło światła LED E14 9W 1170lm 4000K 170-250V C37 DIM	220°	9W	4000K	1170lm	E14	ceramika

Źródło światła LED CERAMIC E14 7W 1000lm G45



5-lat gwarancji	220°	ON OFF 50000	G45	30000 h L70B50	voltage 170-250V AC	142 lm W	IP20
GOOD HEAT DISSIPATION	flicker free	45 mm	SMD 2835	glass	ceramic	PF 0,5	



201729

LED line PRIME

SYMBOL	NAZWA	KĄT ŚWIECENIA	MOC	TEMPERATURA BARWOWA	STRUMIEŃ ŚWIETLNY	TYP	MATERIAŁ
201729	Źródło światła LED E14 7W 1000lm 2700K 170-250V G45 kulka	220°	7W	2700K	1000lm	E14	ceramika
201736	Źródło światła LED E14 7W 1000lm 4000K 170-250V G45 kulka	220°	7W	4000K	1000lm	E14	ceramika
201743	Źródło światła LED E14 7W 1000lm 6500K 170-250V G45 kulka	220°	7W	6500K	1000lm	E14	ceramika

Źródło światła LED CERAMIC E27 7W 1000lm G45



247590-II

LED line PRIME

SYMBOL	NAZWA	KĄT ŚWIECENIA	MOC	TEMPERATURA BARWOWA	STRUMIEŃ ŚWIETLNY	TYP	MATERIAŁ
247590-II	Źródło światła LED E27 7W 1000lm 2700K 170-250V G45 kulka	220°	7W	2700K	1000lm	E27	ceramika
247606-II	Źródło światła LED E27 7W 1000lm 4000K 170-250V G45 kulka	220°	7W	4000K	1000lm	E27	ceramika
201774	Źródło światła LED E27 7W 1000lm 6500K 170-250V G45 kulka	220°	7W	6500K	1000lm	E27	ceramika

Źródło światła LED CERAMIC E27 6W 840lm A60

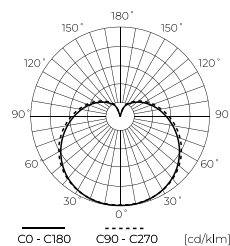

201781

201781

LED line PRIME

SYMBOL	NAZWA	KĄT ŚWIECENIA	MOC	TEMPERATURA BARWOWA	STRUMIEŃ ŚWIETLNY	TYP	MATERIAŁ
201781	Źródło światła LED E27 6W 840lm 2700K 170-250V A60	280°	6W	2700K	840lm	E27	ceramika
201798	Źródło światła LED E27 6W 840lm 4000K 170-250V A60	280°	6W	4000K	840lm	E27	ceramika
201804	Źródło światła LED E27 6W 840lm 6500K 170-250V A60	280°	6W	6500K	840lm	E27	ceramika

Źródło światła LED CERAMIC E27 10W 1400lm A60



5-lat gwarancji	220-280°	ON OFF 50000	A60	30000 h L70B50	voltage 170-250V AC	140 lm W	IP20
GOOD HEAT DISSIPATION	flicker free	60 mm	SMD 2835	glass	ceramic	PF 0,5-0,7	

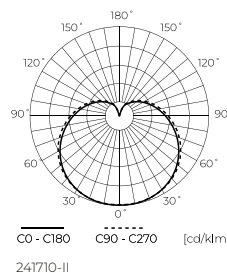

241710-II

LED line PRIME

SYMBOL	NAZWA	KĄT ŚWIECENIA	MOC	TEMPERATURA BARWOWA	STRUMIEŃ ŚWIETLNY	TYP	MATERIAŁ
241710-II	Źródło światła LED E27 10W 1400lm 2700K 170-250V A60	280°	10W	2700K	1400lm	E27	ceramika
241727-II	Źródło światła LED E27 10W 1400lm 4000K 170-250V A60	280°	10W	4000K	1400lm	E27	ceramika
201835	Źródło światła LED E27 10W 1400lm 6500K 170-250V A60	280°	10W	6500K	1400lm	E27	ceramika

Źródło światła LED CERAMIC E27 13W 1820lm A60



5-lat gwarancji	220°	ON OFF 50000	A60	30000 h L70B50	voltage 170-250V AC	140 lm W	IP20
GOOD HEAT DISSIPATION	flicker free	60 mm	SMD 2835	glass	ceramic	PF 0,7	

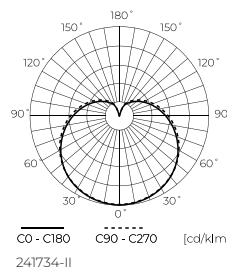

241734-II

LED line PRIME

SYMBOL	NAZWA	KĄT ŚWIECENIA	MOC	TEMPERATURA BARWOWA	STRUMIEŃ ŚWIETLNY	TYP	MATERIAŁ
241734-II	Źródło światła LED E27 13W 1820lm 2700K 170-250V A60	280°	13W	2700K	1820lm	E27	ceramika
241772-II	Źródło światła LED E27 13W 1820lm 4000K 170-250V A60	280°	13W	4000K	1820lm	E27	ceramika



5-lat gwarancji	glass	ON OFF	L70B50	voltage	Im W	IP
GOOD HEAT DISSIPATION	flicker free	mm			ceramic	PF



201453

LED line PRIME

SYMBOL	NAZWA	KĄT ŚWIECENIA	MOC	TEMPERATURA BARWOWA	STRUMIEŃ ŚWIETLNY	TYP	MATERIAŁ
201453	Źródło światła LED GU10 5W 700lm 2700K 170-250V	120°	5W	2700K	700lm	GU10	ceramika
201460	Źródło światła LED GU10 5W 700lm 4000K 170-250V	120°	5W	4000K	700lm	GU10	ceramika
201477	Źródło światła LED GU10 5W 700lm 6500K 170-250V	120°	5W	6500K	700lm	GU10	ceramika

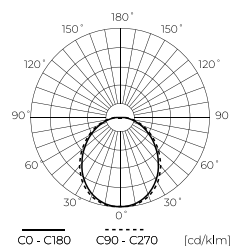
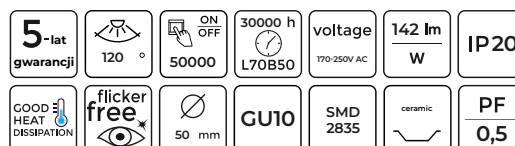
**Źródło światła LED CERAMIC GU10
 7W 1000lm**

247613-II



247613-II

LED line PRIME

SYMBOL	NAZWA	KĄT ŚWIECENIA	MOC	TEMPERATURA BARWOWA	STRUMIEŃ ŚWIETLNY	TYP	MATERIAŁ
247613-II	Źródło światła LED GU10 7W 1000lm 2700K 170-250V	120°	7W	2700K	1000lm	GU10	ceramika
247620-II	Źródło światła LED GU10 7W 1000lm 4000K 170-250V	120°	7W	4000K	1000lm	GU10	ceramika
240737-II	Źródło światła LED GU10 7W 1000lm 6500K 170-250V	120°	7W	6500K	1000lm	GU10	ceramika

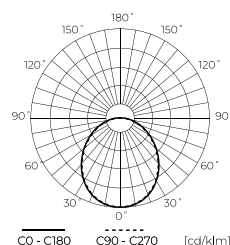
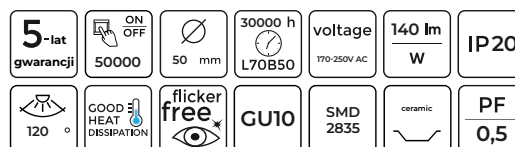
**Źródło światła LED CERAMIC GU10 10W
 1400lm**

248580-II



248580-II

LED line PRIME

SYMBOL	NAZWA	KĄT ŚWIECENIA	MOC	TEMPERATURA BARWOWA	STRUMIEŃ ŚWIETLNY	TYP	MATERIAŁ
248580-II	Źródło światła LED GU10 10W 2700K 1400lm 170-250V	120°	10W	2700K	1400lm	GU10	ceramika
248597-II	Źródło światła LED GU10 10W 4000K 1400lm 170-250V	120°	10W	4000K	1400lm	GU10	ceramika
248603-II	Źródło światła LED GU10 10W 6500K 1400lm 170-250V	120°	10W	6500K	1400lm	GU10	ceramika
470218-II	Źródło światła LED GU10 10W 2700K 1250lm 170-250V DIM	120°	10W	2700K	1250lm	GU10	ceramika
470225-II	Źródło światła LED GU10 10W 4000K 1250lm 170-250V DIM	120°	10W	4000K	1250lm	GU10	ceramika

Źródło światła LED CERAMIC GU11 3W 330lm

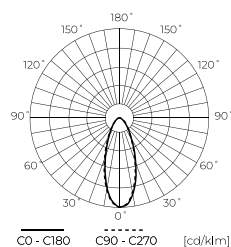
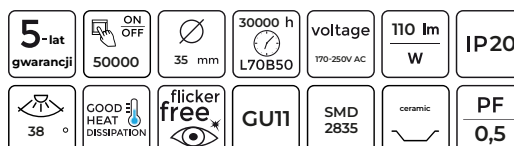

LED line PRIME

248108-II

248108-II

SYMBOL	NAZWA	KĄT ŚWIECENIA	MOC	TEMPERATURA BARWOWA	STRUMIEŃ ŚWIETLNY	TYP	MATERIAŁ
248108-II	Źródło światła LED CERAMIC GU11 3W 330lm 170-250V 110lm/W	38°	3W	2700K	330lm	GU11	ceramika
248122-II	Źródło światła LED CERAMIC GU11 3W 330lm 4000K	38°	3W	4000K	330lm	GU11	ceramika
248115-II	Źródło światła LED CERAMIC GU11 3W 330lm 6500K	38°	3W	6500K	330lm	GU11	ceramika

Źródło światła LED CERAMIC MR16 3W 330lm AC/DC

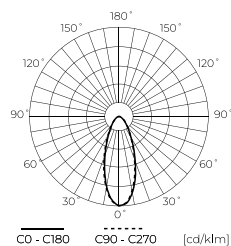
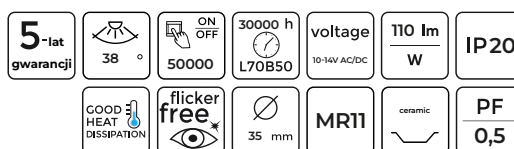

LED line PRIME

248139-II

248139-II

SYMBOL	NAZWA	KĄT ŚWIECENIA	MOC	TEMPERATURA BARWOWA	STRUMIEŃ ŚWIETLNY	TYP	MATERIAŁ
248139-II	Źródło światła LED CERAMIC MR11 3W 2700K 330lm 10-14V	38°	3W	2700K	330lm	MR11	ceramika
248146-II	Źródło światła LED CERAMIC MR11 3W 4000K 330lm 10-14V	38°	3W	4000K	330lm	MR11	ceramika
248153-II	Źródło światła LED CERAMIC MR11 3W 6500K 330lm 10-14V	38°	3W	6500K	330lm	MR11	ceramika

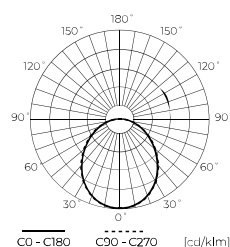
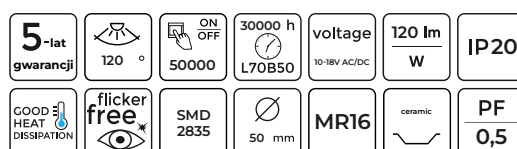
**Źródło światła LED CERAMIC MR16
 5W 600lm AC/DC**

LED line PRIME

201903

201903

SYMBOL	NAZWA	KĄT ŚWIECENIA	MOC	TEMPERATURA BARWOWA	STRUMIEŃ ŚWIETLNY	TYP	MATERIAŁ
201903	Źródło światła LED CERAMIC MR16 5W 600lm 2700K 10-18V	120°	5W	2700K	600lm	MR16	ceramika
201910	Źródło światła LED CERAMIC MR16 5W 600lm 4000K 10-18V	120°	5W	4000K	600lm	MR16	ceramika
201927	Źródło światła LED CERAMIC MR16 5W 600lm 6500K 10-18V	120°	5W	6500K	600lm	MR16	ceramika

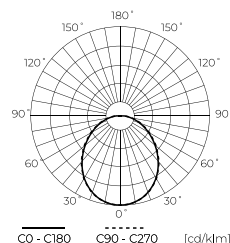
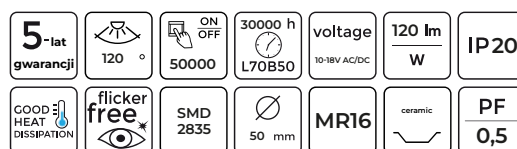
**Źródło światła LED CERAMIC MR16
 8,5W 1020lm AC/DC**

LED line PRIME

201934

201934

SYMBOL	NAZWA	KĄT ŚWIECENIA	MOC	TEMPERATURA BARWOWA	STRUMIEŃ ŚWIETLNY	TYP	MATERIAŁ
201934	Źródło światła LED CERAMIC MR16 8,5W 1020lm 2700K 10-18V	120°	8,5W	2700K	1020lm	MR16	ceramika
201941	Źródło światła LED CERAMIC MR16 8,5W 1020lm 4000K 10-18V	120°	8,5W	4000K	1020lm	MR16	ceramika
201958	Źródło światła LED CERAMIC MR16 8,5W 1020lm 6500K 10-18V	120°	8,5W	6500K	1020lm	MR16	ceramika

Źródło światła LED CERAMIC SMD 5W 400lm

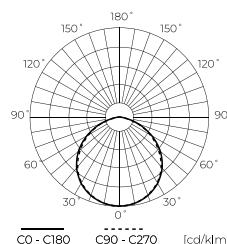
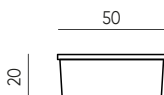
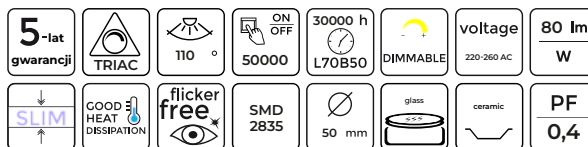

LED line PRIME

247286

247286

SYMBOL	NAZWA	KĄT ŚWIECENIA	MOC	TEMPERATURA BARWOWA	STRUMIEŃ ŚWIETLNY	TYP	MATERIAŁ	DIM
247286	Źródło światła LED SMD 5W 400lm 2700K 220-260V 50mm	110°	5W	2700K	400lm	SMD	ceramika	NO
470720	Źródło światła LED SMD 5W 400lm 2700K 220-260V 50mm DIM	110°	5W	2700K	400lm	SMD	ceramika TRIAC	
247293	Źródło światła LED SMD 5W 400lm 4000K 220-260V 50mm	110°	5W	4000K	400lm	SMD	ceramika	NO
470737	Źródło światła LED SMD 5W 400lm 4000K 220-260V 50mm DIM	110°	5W	4000K	400lm	SMD	ceramika TRIAC	
470560	Źródło światła LED SMD 5W 400lm 6500K 220-260V 50mm	110°	5W	6500K	400lm	SMD	ceramika	NO
470744	Źródło światła LED SMD 5W 400lm 6500K 220-260V 50mm DIM	110°	5W	6500K	400lm	SMD	ceramika TRIAC	

Źródło światła LED CERAMIC G9 4W 350lm

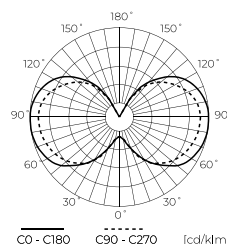
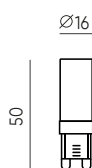
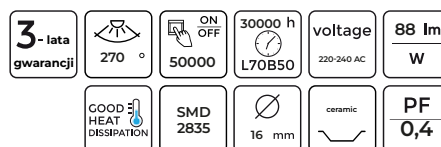

LED line LITE

245480

245480

SYMBOL	NAZWA	KĄT ŚWIECENIA	MOC	TEMPERATURA BARWOWA	STRUMIEŃ ŚWIETLNY	TYP	MATERIAŁ
245480	Źródło światła LED G9 4W 350lm 2700K 220-240V	270°	4W	2700K	350lm	G9	ceramika
245534	Źródło światła LED G9 4W 350lm 4000K 220-240V	270°	4W	4000K	350lm	G9	ceramika
245541	Źródło światła LED G9 4W 350lm 6000K 220-240V	270°	4W	6000K	350lm	G9	ceramika

Źródło światła LED CERAMIC G9 6W 550lm

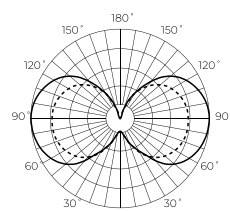
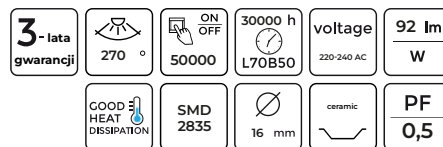
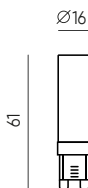

CO - C180 C90 - C270 [cd/klm]
245947

245947

LED line LITE

SYMBOL	NAZWA	KĄT ŚWIECENIA	MOC	TEMPERATURA BARWOWA	STRUMIEŃ ŚWIETLNY	TYP MATERIAŁ
245947	Źródło światła LED G9 6W 550lm 2700K 220-240V	270°	6W	2700K	550lm	G9 ceramika
245954	Źródło światła LED G9 6W 550lm 4000K 220-240V	270°	6W	4000K	550lm	G9 ceramika
245961	Źródło światła LED G9 6W 550lm 6000K 220-240V	270°	6W	6000K	550lm	G9 ceramika

Źródło światła LED CERAMIC G9 8W 750lm

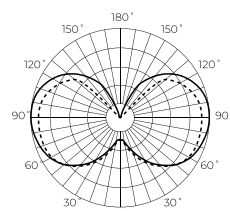
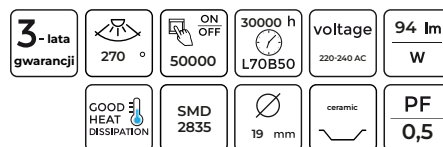
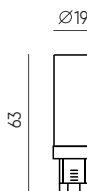

CO - C180 C90 - C270 [cd/klm]
247903

247903

LED line LITE

SYMBOL	NAZWA	KĄT ŚWIECENIA	MOC	TEMPERATURA BARWOWA	STRUMIEŃ ŚWIETLNY	TYP MATERIAŁ
247903	Źródło światła LED G9 8W 750lm 2700K 220-240V	270°	8W	2700K	750lm	G9 ceramika
247910	Źródło światła LED G9 8W 750lm 4000K 220-240V	270°	8W	4000K	750lm	G9 ceramika
247927	Źródło światła LED G9 8W 750lm 6000K 220-240V	270°	8W	6000K	750lm	G9 ceramika

Źródło światła LED CERAMIC G9 12W 1160lm

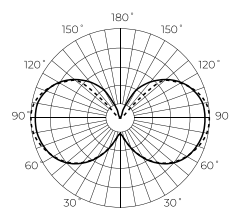
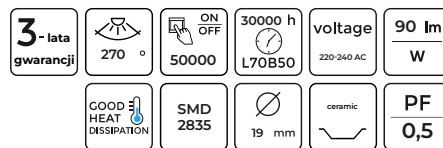
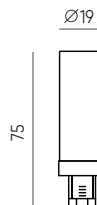

CO - C180 C90 - C270 [cd/klm]
248900

248900

LED line LITE

SYMBOL	NAZWA	KĄT ŚWIECENIA	MOC	TEMPERATURA BARWOWA	STRUMIEŃ ŚWIETLNY	TYP	MATERIAŁ
248900	Źródło światła LED G9 12W 1160lm 2700K 220-240V	270°	12W	2700K	1160lm	G9	ceramika
248917	Źródło światła LED G9 12W 1160lm 4000K 220-240V	270°	12W	4000K	1160lm	G9	ceramika
248924	Źródło światła LED G9 12W 1160lm 6000K 220-240V	270°	12W	6000K	1160lm	G9	ceramika



ŹRÓDŁO ŚWIATŁA LED GLASS

**Źródło światła LED GLASS GU10 1W
 220-240V**

LED line LITE

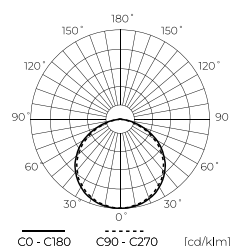
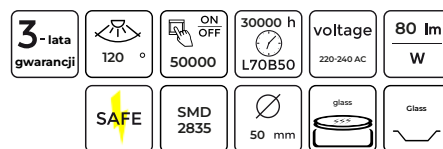
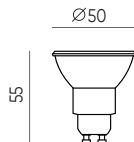

C0 - C180 C90 - C270 [cd/klm]



242250

SYMBOL	NAZWA	KĄT ŚWIECENIA	MOC	TEMPERATURA BARWOWA	STRUMIEŃ ŚWIETLNY	TYP	MATERIAŁ
242250	Źródło światła LED GU10 1W 80lm 2700K 220-260V	120°	1W	2700K	80lm	GU10	szkło
248337	Źródło światła LED GU10 1W 80lm 4000K 220-260V	120°	1W	4000K	80lm	GU10	szkło
242267	Źródło światła LED GU10 1W 80lm 6500K 220-260V	120°	1W	6500K	80lm	GU10	szkło

**Źródło światła LED GLASS GU10
 1W 220-240V**

LED line LITE

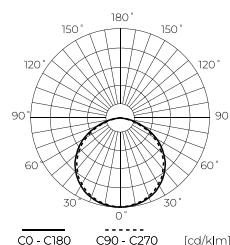
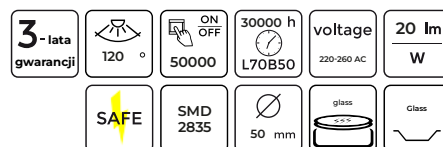
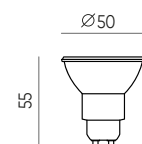

C0 - C180 C90 - C270 [cd/klm]



242298

242298

SYMBOL	NAZWA	KĄT ŚWIECENIA	MOC	TEMPERATURA BARWOWA	STRUMIEŃ ŚWIETLNY	TYP	MATERIAŁ
242298	Źródło światła LED GU10 1W 20lm 220-260V zielone	120°	1W	Zielony 520nm	20lm	GU10	szkło
242281	Źródło światła LED GU10 1W 20lm 220-260V niebieskie	120°	1W	Niebieski 465nm	20lm	GU10	szkło

Źródło światła LED GLASS GU10 3W 273lm 220-260V

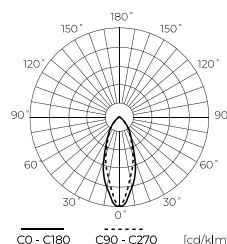
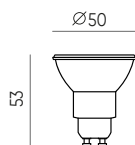
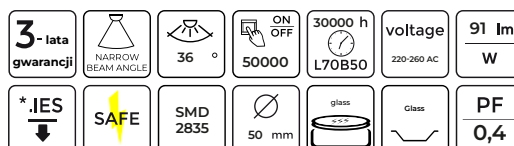

247835

247835

LED line LITE

SYMBOL	NAZWA	KĄT ŚWIECENIA	MOC	TEMPERATURA BARWOWA	STRUMIEŃ ŚWIETLNY	TYP	MATERIAŁ
247835	Źródło światła LED GU10 3W 273lm 2700K 220-260V 36°	36°	3W	2700K	273lm	GU10	szkło
247828	Źródło światła LED GU10 3W 273lm 4000K 220-260V 36°	36°	3W	4000K	273lm	GU10	szkło
247811	Źródło światła LED GU10 3W 273lm 6500K 220-260V 36°	36°	3W	6500K	273lm	GU10	szkło

Źródło światła LED GLASS GU10 5W 450lm 220-260V 120°

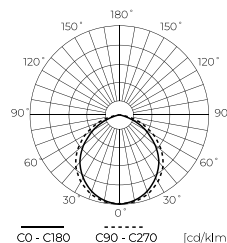
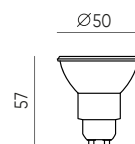
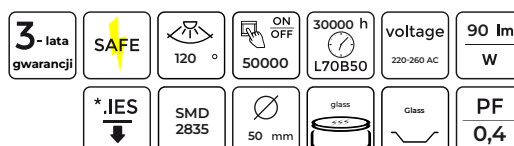

241963

241963

LED line LITE

SYMBOL	NAZWA	KĄT ŚWIECENIA	MOC	TEMPERATURA BARWOWA	STRUMIEŃ ŚWIETLNY	TYP	MATERIAŁ
241963	Źródło światła LED GU10 5W 450lm 2700K 220-260V 120°	120°	5W	2700K	450lm	GU10	szkło
241970	Źródło światła LED GU10 5W 450lm 4000K 220-260V 120°	120°	5W	4000K	450lm	GU10	szkło
241987	Źródło światła LED GU10 5W 450lm 6500K 220-260V 120°	120°	5W	6500K	450lm	GU10	szkło

Źródło światła LED GLASS GU10 5,5W 500lm 220-260V 50° DIMMABLE

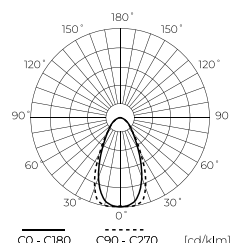
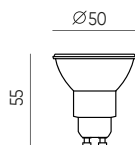
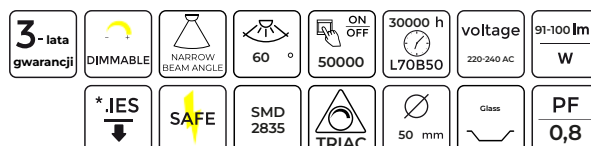

240621

240621

LED line LITE

SYMBOL	NAZWA	KĄT ŚWIECENIA	MOC	TEMPERATURA BARWOWA	STRUMIEŃ ŚWIETLNY	TYP	MATERIAŁ
240621	Źródło światła LED M16 5,5W 500lm 2700K 220-240V DIM	60°	5,5W	2700K	500lm	GU10	szkło
240638	Źródło światła LED M16 5,5W 550lm 4000K 220-240V DIM	60°	5,5W	4000K	550lm	GU10	szkło

Źródło światła LED GLASS GU10 5,5W 345lm 220-260V 60° DIM TO WARM

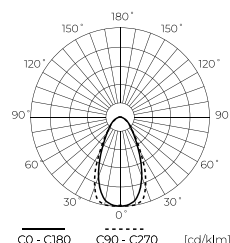
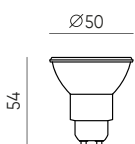
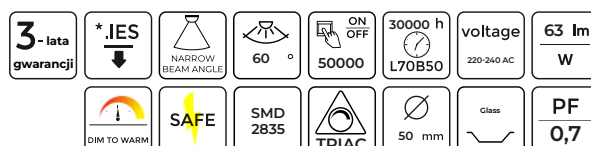

248948

LED line LITE

SYMBOL	NAZWA	KĄT ŚWIECENIA	MOC	TEMPERATURA BARWOWA	STRUMIEŃ ŚWIETLNY	TYP	MATERIAŁ
248948	Źródło światła LED GU10 5,5W 345lm 2200-3000K 220-240V	60°	5,5W	2200-3000K	345lm	GU10	szkło

Źródło światła LED GLASS MR11 3W 273lm 10-14V 36°

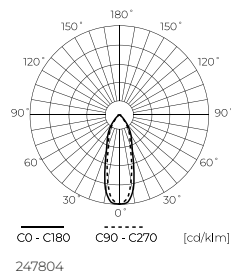
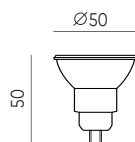
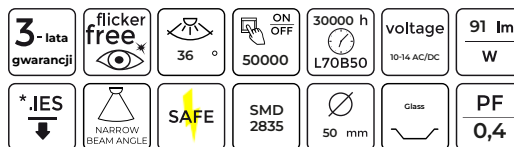

LED line LITE

SYMBOL	NAZWA	KĄT ŚWIECENIA	MOC	TEMPERATURA BARWOWA	STRUMIEŃ ŚWIETLNY	TYP	MATERIAŁ
247804	Źródło światła LED MR11 3W 273lm 2700K 10-14V AC/DC 36°	36°	3W	2700K	273lm	MR11	szkło
247798	Źródło światła LED MR11 3W 273lm 4000K 10-14V AC/DC 36°	36°	3W	4000K	273lm	MR11	szkło
247781	Źródło światła LED MR11 3W 273lm 6500K 10-14V AC/DC 36°	36°	3W	6500K	273lm	MR11	szkło



szeroki wybór modeli

przezroczyste, złote i grafitowe szkło

najlepsza funkcja ściemniania na rynku



ŹRÓDŁO ŚWIATŁA LED FILAMENT

Źródło światła LED FILAMENT E27 4W 840lm 4000K A60



LED line PRIME

SYMBOL	NAZWA	MOC	TEMPERATURA BARWOWA	STRUMIEŃ ŚWIETLNY	KSZTAŁT	TYP
202344	Źródło światła LED FILAMENT E27 4W 840lm 4000K 220-240V A60 KULKA	4W	4000K	840lm	A60	E27

Źródło światła LED FILAMENT E27 7W 1470lm 4000K A60

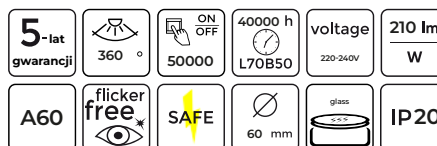

LED line PRIME

SYMBOL	NAZWA	MOC	TEMPERATURA BARWOWA	STRUMIEŃ ŚWIETLNY	KSZTAŁT	TYP
202351	Źródło światła LED FILAMENT E27 7W 1470lm 4000K 220-240V A60 KULKA	7W	4000K	1470lm	A60	E27

Źródło światła LED FILAMENT E27 4W 1470lm 1800K ST64 RETRO



LED line PRIME

202405

SYMBOL	NAZWA	MOC	TEMPERATURA BARWOWA	STRUMIEŃ ŚWIETLNY	KSZTAŁT	TYP
202405	Źródło światła LED FILAMENT E27 4W 210lm 1800K 220-240V ST64 RETRO VINTAGE Żółty ŚCIEMIALNE	4W	1800K	210lm	ST64	E27
202412	Źródło światła LED FILAMENT E27 4W 150lm 1800K 220-240V ST64 RETRO VINTAGE GRAFIT ŚCIEMIALNE	4W	1800K	150lm	ST64	E27
202399	Źródło światła LED FILAMENT E27 4W 230lm 1800K 220-240V ST64 RETRO VINTAGE ŚCIEMIALNE	4W	1800K	230lm	ST64	E27

Źródło światła LED FILAMENT E27 4W 1800K G125 RETRO



202375

LED line PRIME

SYMBOL	NAZWA	MOC	TEMPERATURA BARWOWA	STRUMIEŃ ŚWIETLNY	KSZTAŁT	TYP
202375	Źródło światła LED FILAMENT E27 4W 210lm 1800K 220-240V G125 RETRO VINTAGE Żłoty ŚCIEMIALNE	4W	1800K	210lm	G125	E27
202382	Źródło światła LED FILAMENT E27 4W 210lm 1800K 220-240V G125 RETRO VINTAGE GRAFIT ŚCIEMIALNE	4W	1800K	150lm	G125	E27
202368	Źródło światła LED FILAMENT E27 4W 210lm 1800K 220-240V G125 RETRO VINTAGE ŚCIEMIALNE	4W	1800K	230lm	G125	E27

Źródło światła LED FILAMENT E14 4W 480lm C35

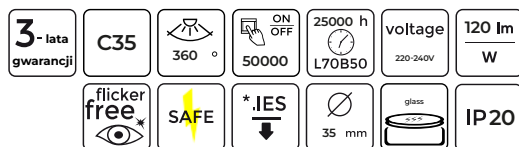

202184

LED line LITE

SYMBOL	NAZWA	MOC	TEMPERATURA BARWOWA	STRUMIEŃ ŚWIETLNY	KSZTAŁT	TYP
202184	Źródło światła LED FILAMENT E14 4W 480lm 2700K 220-240V C35 ŚWIECZKA	4W	2700K	480lm	C35	E14
202191	Źródło światła LED FILAMENT E14 4W 480lm 4000K 220-240V C35 ŚWIECZKA	4W	4000K	480lm	C35	E14

LED FILAMENT light source E14 5W 600lm C35 DIM



202306

LED line LITE

SYMBOL	NAZWA	MOC	TEMPERATURA BARWOWA	STRUMIEŃ ŚWIETLNY	KSZTAŁT	TYP
202306	Źródło światła LED FILAMENT E14 5W 600lm 2700K 220-240V C35 ŚWIECZKA ŚCIEMIALNE	5W	2700K	600lm	C35	E14
202313	Źródło światła LED FILAMENT E14 5W 600lm 4000K 220-240V C35 ŚWIECZKA ŚCIEMIALNE	5W	4000K	600lm	C35	E14

Źródło światła LED FILAMENT E14 6W 720lm C35



202207

LED line LITE

SYMBOL	NAZWA	MOC	TEMPERATURA BARWOWA	STRUMIEŃ ŚWIETLNY	KSZTAŁT	TYP
202207	Źródło światła LED FILAMENT E14 6W 720lm 2700K 220-240V C35 ŚWIECZKA	6W	2700K	720lm	C35	E14
202214	Źródło światła LED FILAMENT E14 6W 720lm 4000K 220-240V C35 ŚWIECZKA	6W	4000K	720lm	C35	E14

Źródło światła LED FILAMENT E14 4W 480lm G45

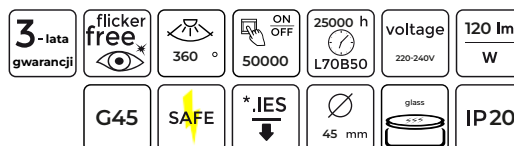

202221

LED line LITE

SYMBOL	NAZWA	MOC	TEMPERATURA BARWOWA	STRUMIEŃ ŚWIETLNY	KSZTAŁT	TYP
202221	Źródło światła LED FILAMENT E14 4W 480lm 2700K 220-240V G45 KULKA	4W	2700K	480lm	G45	E14
202238	Źródło światła LED FILAMENT E14 4W 480lm 4000K 220-240V G45 KULKA	4W	4000K	480lm	G45	E14

Źródło światła LED FILAMENT E27 7W 840lm A60

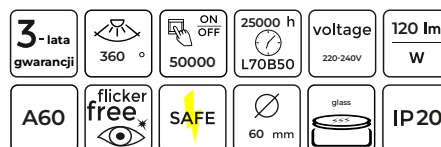

202269

LED line LITE

SYMBOL	NAZWA	MOC	TEMPERATURA BARWOWA	STRUMIEŃ ŚWIETLNY	KSZTAŁT	TYP
202269	Źródło światła LED FILAMENT E27 7W 840lm 2700K 220-240V A60 KULKA	7W	2700K	840lm	A60	E27
202276	Źródło światła LED FILAMENT E27 7W 840lm 4000K 220-240V A60 KULKA	7W	4000K	840lm	A60	E27

Źródło światła LED FILAMENT E27 7W 840lm A60 DIMMABLE

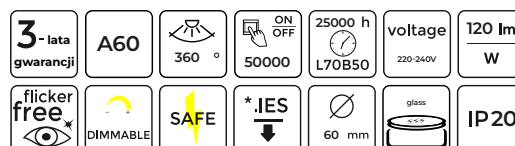

202320

LED line LITE

SYMBOL	NAZWA	MOC	TEMPERATURA BARWOWA	STRUMIEŃ ŚWIETLNY	KSZTAŁT	TYP
202320	Źródło światła LED FILAMENT E27 7W 840lm 2700K 220-240V A60 KULKA ŚCIEMIALNA	7W	2700K	840lm	A60	E27
202337	Źródło światła LED FILAMENT E27 7W 840lm 4000K 220-240V A60 KULKA ŚCIEMIALNA	7W	4000K	840lm	A60	E27

Źródło światła LED FILAMENT E27 10W 1200lm A60

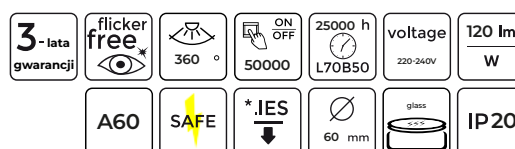

202283

LED line LITE

SYMBOL	NAZWA	MOC	TEMPERATURA BARWOWA	STRUMIEŃ ŚWIETLNY	KSZTAŁT	TYP
202283	Źródło światła LED FILAMENT E27 10W 1200lm 2700K 220-240V A60 KULKA	10W	2700K	1200lm	A60	E27
202290	Źródło światła LED FILAMENT E27 10W 1200lm 4000K 220-240V A60 KULKA	10W	4000K	1200lm	A60	E27

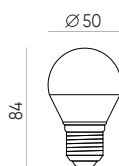

ŹRÓDŁO ŚWIATŁA LED
BASIC

**Źródło światła LED BASIC E27 6W
510lm A60**

3-lata gwarancji	240 °	50000 h L70B50	voltage 220-240 AC	85 lm W
45 mm	PVC	ON OFF 50000	PF 0,5	



247255

LED line LITE

SYMBOL	NAZWA	KĄT ŚWIECENIA	MOC	TEMPERATURA BARWOWA	STRUMIEŃ ŚWIETLNY	TYP	MATERIAŁ
247255	Źródło światła LED E27 6W 510lm 3000K 220-260V A60	240°	6W	3000K	510lm	E27	plastik
247262	Źródło światła LED E27 6W 510lm 4000K 220-260V A60	240°	6W	4000K	510lm	E27	plastik

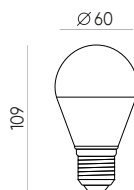
**Źródło światła LED BASIC E27 10W
940lm A60**

3-lata gwarancji	240 °	30000 h L70B50	voltage 220-240 AC	91 lm W
60 mm	PVC	ON OFF 50000	PF 0,5	



247385

LED line LITE

SYMBOL	NAZWA	KĄT ŚWIECENIA	MOC	TEMPERATURA BARWOWA	STRUMIEŃ ŚWIETLNY	TYP	MATERIAŁ
247385	Źródło światła LED E27 10W 940lm 3000K 220-260V A60	240°	10W	3000K	940lm	E27	plastik
247392	Źródło światła LED E27 10W 940lm 4000K 220-260V A60	240°	10W	4000K	940lm	E27	plastik

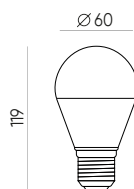
**Źródło światła LED BASIC E27 15W
1515lm A60**

3-lata gwarancji	240 °	50000 h L70B50	voltage 220-240 AC	101 lm W
60 mm	PVC	ON OFF 50000	PF 0,5	



247422

LED line LITE

SYMBOL	NAZWA	KĄT ŚWIECENIA	MOC	TEMPERATURA BARWOWA	STRUMIEŃ ŚWIETLNY	TYP	MATERIAŁ
247422	Źródło światła LED E27 15W 1515lm 3000K 220-260V A60	240°	15W	3000K	1515lm	E27	plastik
247439	Źródło światła LED E27 15W 1515lm 4000K 220-260V A60	240°	15W	4000K	1515lm	E27	plastik

Źródło światła LED BASIC E27 1W 80lm 3000K G45

3-lata gwarancji	50000 h L70B50	voltage 220-240 AC	80 lm W
270 °	45 mm	ON OFF 50000	PF 0,5

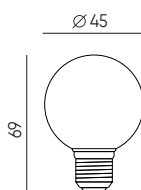

470317

LED line LITE

SYMBOL	NAZWA	KĄT ŚWIECENIA	MOC	TEMPERATURA BARWOWA	STRUMIEŃ ŚWIETLNY	TYP	MATERIAŁ
470317	Źródło światła LED E27 1W 80lm 3000K 220-260V G45	270°	1W	3000K	80lm	E27	plastik

Źródło światła LED BASIC E14 6W 522lm C37

3-lata gwarancji	50000 h L70B50	voltage 220-240 AC	87 lm W
180 °	37 mm	ON OFF 50000	PF 0,5

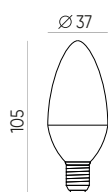

247354

LED line LITE

SYMBOL	NAZWA	KĄT ŚWIECENIA	MOC	TEMPERATURA BARWOWA	STRUMIEŃ ŚWIETLNY	TYP	MATERIAŁ
247354	Źródło światła LED E14 6W 3000K 522lm 220-240V C37	180°	6W	3000K	522lm	E14	plastik
247347	Źródło światła LED E14 6W 4000K 522lm 220-240V C37	180°	6W	4000K	522lm	E14	plastik

Źródło światła LED BASIC E14 8W 720lm C37

3-lata gwarancji	50000 h L70B50	voltage 220-240 AC	90 lm W
180 °	37 mm	ON OFF 50000	PF 0,5

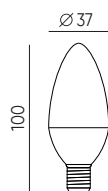

471215

LED line LITE

SYMBOL	NAZWA	KĄT ŚWIECENIA	MOC	TEMPERATURA BARWOWA	STRUMIEŃ ŚWIETLNY	TYP	MATERIAŁ
471215	Źródło światła LED E14 8W 720lm 3000K 220-260V C37	180°	8W	3000K	720lm	E14	plastik
471222	Źródło światła LED E14 8W 720lm 4000K 220-260V C37	180°	8W	4000K	720lm	E14	plastik

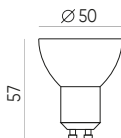
**Źródło światła LED BASIC GU10 3W
240lm**

3-lata gwarancji	50000 h L70B50	voltage 220-240 AC	80 lm W
120 °	50 mm	ON OFF 50000	PF 0,5



248658

LED line LITE

SYMBOL	NAZWA	KĄT ŚWIECENIA	MOC	TEMPERATURA BARWOWA	STRUMIEŃ ŚWIETLNY	TYP	MATERIAŁ
248658	Źródło światła LED GU10 3W 240lm 3000K 220-260V	120°	3W	3000K	240lm	GU10	plastik
248665	Źródło światła LED GU10 3W 240lm 4000K 220-260V	120°	3W	4000K	240lm	GU10	plastik
244001	Źródło światła LED GU10 3W 240lm 6500K 220-260V	120°	3W	6500K	240lm	GU10	plastik

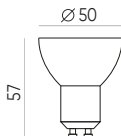
**Źródło światła LED BASIC GU10 5W
450lm**

3-lata gwarancji	50000 h L70B50	voltage 220-240 AC	90 lm W
120 °	50 mm	ON OFF 50000	PF 0,5



248689

LED line LITE

SYMBOL	NAZWA	KĄT ŚWIECENIA	MOC	TEMPERATURA BARWOWA	STRUMIEŃ ŚWIETLNY	TYP	MATERIAŁ
248689	Źródło światła LED GU10 5W 450lm 3000K 220-260V	120°	5W	3000K	450lm	GU10	plastik
244346	Źródło światła LED GU10 5W 450lm 4000K 220-260V	120°	5W	4000K	450lm	GU10	plastik

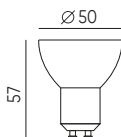
**Źródło światła LED BASIC GU10 7W
600lm**

3-lata gwarancji	50000 h L70B50	voltage 220-240 AC	83 lm W
120 °	50 mm	ON OFF 50000	PF 0,5



244728

LED line LITE

SYMBOL	NAZWA	KĄT ŚWIECENIA	MOC	TEMPERATURA BARWOWA	STRUMIEŃ ŚWIETLNY	TYP	MATERIAŁ
244728	Źródło światła LED GU10 7W 600lm 3000K 220-260V	120°	5W	3000K	600lm	GU10	plastik
244766	Źródło światła LED GU10 7W 600lm 6500K 220-260V	120°	5W	6500K	600lm	GU10	plastik

Źródło światła LED G4 COB 1,5W 120lm

3-lata gwarancji	360°	30000 h L70B50	voltage 10-18 AC/DC	80 lm W
ON OFF 50000	1 LED	COB	PF 0,5	

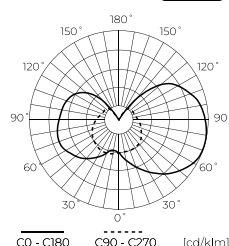
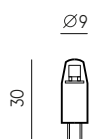

LED line LITE

248979

248979

SYMBOL	NAZWA	KĄT ŚWIECENIA	MOC	TEMPERATURA BARWOWA	STRUMIEŃ ŚWIETLNY	TYP	MATERIAŁ
248979	Źródło światła LED G4 COB 1,5W 120lm 2700K 12V AC/DC	360°	1,5W	2700K	120lm	G4	silikon
248986	Źródło światła LED G4 COB 1,5W 120lm 6000K 12V AC/DC	360°	1,5W	6000K	120lm	G4	silikon

Źródło światła LED G4 2W 220lm 3000K

3-lata gwarancji	13 mm	voltage 12V DC	110 lm W
270°	50000 h L70B50	ON OFF 50000	



LED line LITE

244506

SYMBOL	NAZWA	KĄT ŚWIECENIA	MOC	TEMPERATURA BARWOWA	STRUMIEŃ ŚWIETLNY	TYP	MATERIAŁ
244506	Źródło światła LED G4 2W 220lm 3000K 12V DC SMD3014 SL	360°	2W	3000K	220lm	G4	silikon

Źródło światła LED G4 2W 12V

3-lata gwarancji	13 mm	voltage 12V AC/DC	80 lm W
270°	50000 h L70B50	ON OFF 50000	

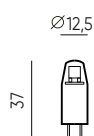

LED line LITE

244520

SYMBOL	NAZWA	KĄT ŚWIECENIA	MOC	TEMPERATURA BARWOWA	STRUMIEŃ ŚWIETLNY	TYP	MATERIAŁ
244520	Źródło światła LED G4 2W 220lm 6000K 12V DC SMD3014 SL	360°	2W	6000K	220lm	G4	silikon

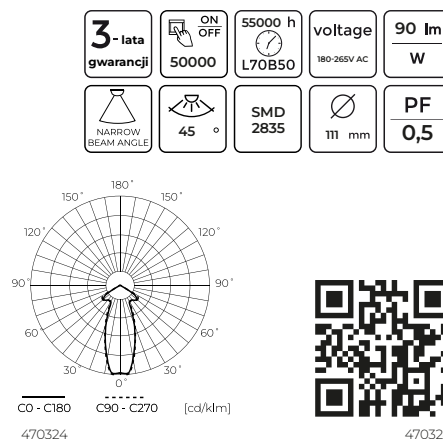
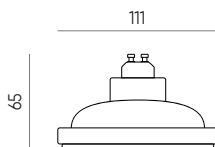
Źródło światła LED ES111 12W 1080lm

LED line LITE

SYMBOL	NAZWA	KĄT ŚWIECENIA	MOC	TEMPERATURA BARWOWA	STRUMIEŃ ŚWIETLNY	TYP
470324	Źródło światła LED ES111 12W 1080lm 2700K 230V AC 45°	45°	12W	2700K	1080lm	GU10
470331	Źródło światła LED ES111 12W 1080lm 4000K 230V AC 45°	45°	12W	4000K	1080lm	GU10

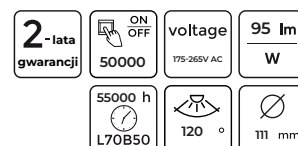
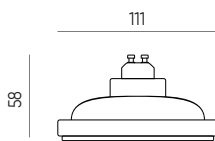
Źródło światła LED ES111 9W 850lm 4000K

LED line LITE

SYMBOL	NAZWA	KĄT ŚWIECENIA	MOC	TEMPERATURA BARWOWA	STRUMIEŃ ŚWIETLNY	TYP
249587	Źródło światła LED ES111 9W 850lm 4000K 175-265V białe	120°	9W	4000K	850lm	GU10

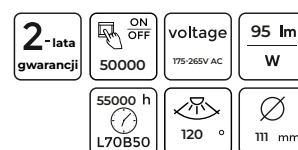
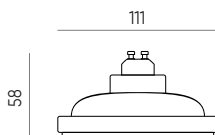
Źródło światła LED ES111 9W 850lm 4000K

LED line LITE

SYMBOL	NAZWA	KĄT ŚWIECENIA	MOC	TEMPERATURA BARWOWA	STRUMIEŃ ŚWIETLNY	TYP
249624	Źródło światła LED ES111 9W 850lm 4000K 175-265V czarne	120°	9W	4000K	850lm	GU10



ŹRÓDŁO ŚWIATŁA LED
T8 LED

T8 LED Tube 150lm/W Glass 220-240V 270°

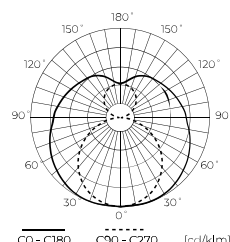
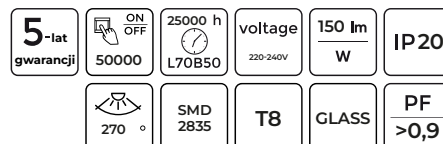

202061

202061

LED line PRIME

SYMBOL	NAZWA	KĄT ŚWIECENIA	MOC	TEMPERATURA BARWOWA	STRUMIEŃ ŚWIETLNY	TYP	MATERIAŁ
202061	LED Tube T8 9W 1350lm 4000K 220-240V 60cm	270°	9W	4000K	1350lm	G13/T8	szkło
202078	LED Tube T8 9W 1350lm 6500K 220-240V 60cm	270°	9W	6500K	1350lm	G13/T8	szkło
202085	LED Tube T8 18W 2700lm 4000K 220-240V 120cm	270°	18W	4000K	2700lm	G13/T8	szkło
202092	LED Tube T8 18W 2700lm 6500K 220-240V 120cm	270°	18W	6500K	2700lm	G13/T8	szkło
202108	LED Tube T8 22W 3300lm 4000K 220-240V 150cm	270°	22W	4000K	3300lm	G13/T8	szkło
202115	LED Tube T8 22W 3300lm 6500K 220-240V 150cm	270°	22W	6500K	3300lm	G13/T8	szkło

T8 LED Tube 100lm/W Glass 220-240V 270°

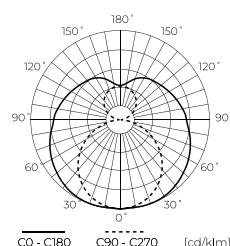
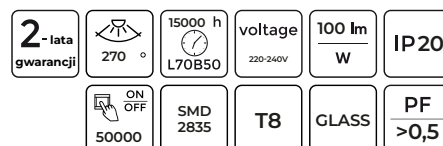

202009

202009

LED line LITE

SYMBOL	NAZWA	KĄT ŚWIECENIA	MOC	TEMPERATURA BARWOWA	STRUMIEŃ ŚWIETLNY	TYP	MATERIAŁ
202009	LED Tube T8 9W 900lm 4000K 220-240V 60cm	270°	9W	4000K	900lm	G13/T8	szkło
202016	LED tube T8 9W 900lm 6500K 220-240V 60cm	270°	9W	6500K	900lm	G13/T8	szkło
202023	LED Tube T8 18W 1820lm 4000K 220-240V 120cm	270°	18W	4000K	1820lm	G13/T8	szkło
202030	LED Tube T8 18W 1820lm 6500K 220-240V 120cm	270°	18W	6500K	1820lm	G13/T8	szkło
202047	LED Tube T8 22W 2265lm 4000K 220-240V 150cm	270°	22W	4000K	2265lm	G13/T8	szkło
202054	LED Tube T8 22W 2265lm 6500K 220-240V 150cm	270°	22W	6500K	2265lm	G13/T8	szkło



ŹRÓDŁO ŚWIATŁA LED
AKCESORIA

Źródło światła LED adapter E14

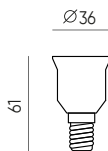
 voltage
 220-240V AC

242052

LED line LITE

SYMBOL	NAZWA	TYP	KSZTAŁT
242052	Źródło światła LED adapter E14->E27	E14	E27
242069	Źródło światła LED adapter E14->GU10	E14	GU10
246173	Źródło światła LED adapter E14->MR16	E14	MR16
246166	Źródło światła LED adapter E14->G9	E14	G9

Źródło światła LED adapter E27

 voltage
 220-240V AC



242076

LED line LITE

SYMBOL	NAZWA	TYP	KSZTAŁT
242076	Źródło światła LED adapter E27->E14	E27	E14
242090	Źródło światła LED adapter E27->GU10	E27	GU10
246210	Źródło światła LED adapter E27->MR16	E27	MR16
246241	Źródło światła LED adapter E27->E40	E27	E40
242083	Źródło światła LED adapter E27->2xE27	E27	2xE27

Przedłużka mocowania żarówki E27

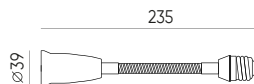
voltage
220-240V AC



242021

LED line LITE

SYMBOL	NAZWA	TYP	KSZTAŁT	DŁUGOŚĆ PRZEDŁUŻENIA
242021	Przedłużka mocowania żarówki LED E27->E27 200mm	E27	E27	20 cm
242038	Przedłużka mocowania żarówki LED E27->E14 200mm	E28	E14	20 cm
242045	Przedłużka mocowania żarówki LED E27->GU10 200mm	E29	GU10	20 cm

Źródło światła LED adapter GU10

voltage
220-240V AC

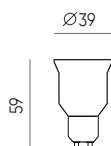

242113

LED line LITE

SYMBOL	NAZWA	TYP	KSZTAŁT
242113	Źródło światła LED adapter GU10->E27	GU10	E27
242106	Źródło światła LED adapter GU10->E14	GU10	E14
246180	Źródło światła LED adapter GU10->MR16	GU10	MR16

Źródło światła LED adapter MR16

voltage
220-240V AC

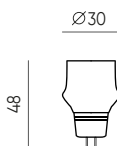

LED line LITE

SYMBOL	NAZWA	TYP	KSZTAŁT
246197	Źródło światła LED adapter MR16->GU10	MR16	GU10

Źródło światła LED adapter E40

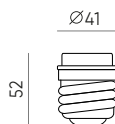
 voltage
 220-240V AC

LED line LITE

SYMBOL	NAZWA	TYP	KSZTAŁT
246289	Źródło światła LED adapter E40->E27	E40	E27

Źródło światła LED adapter B22

 voltage
 220-240V AC

246302

LED line LITE

SYMBOL	NAZWA	TYP	KSZTAŁT
246302	Źródło światła LED adapter B22->E14	B22	E14
246258	Źródło światła LED adapter B22->E27	B22	E27
246272	Źródło światła LED adapter B22->GU10	B22	GU10
246319	Źródło światła LED adapter B22->E40	B22	E40

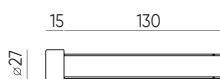
Ceramiczna oprawka z przewodem

246449

SYMBOL	NAZWA	TYP	DŁUGOŚĆ KABLA
246449	Ceramiczna oprawka GU10 z przewodem 13cm	GU10	14 cm
246685	Ceramiczna oprawka GU5,3 z przewodem 16cm	GU5.3	16 cm

nowoczesny,
minimalistyczny
design

funkcja
ściemniania

sterowanie
dotykowe

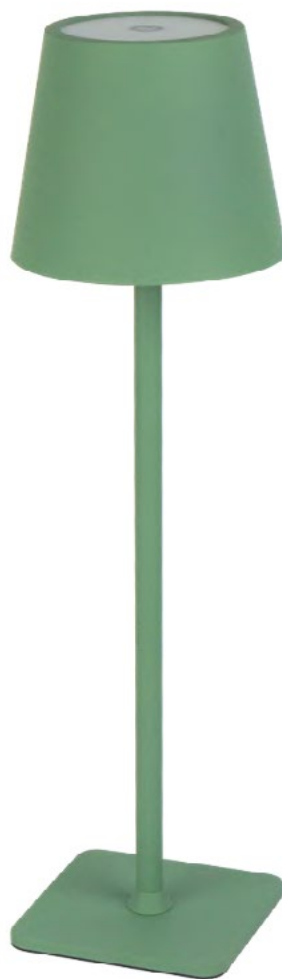

DEKORACYJNE
TAZA

wodoodporność
IP544

uniwersalne
ładowanie USB C

zmiana barwy światła
3000K / 4000K / 5000K

**Lampa stołowa TAZA 3,5W CCT 4000mAh
IP54**

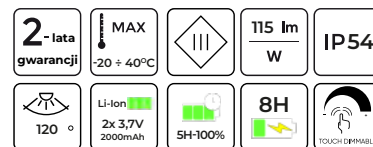
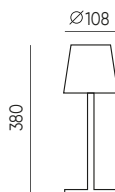

203846

LED line LITE

SYMBOL	NAZWA	MOC	TEMPERATURA BARWOWA	STRUMIEŃ ŚWIETLNY
203846	Lampa stołowa TAZA 3,5W 400lm 3000K - 5000K biała	3,5W	3000K - 5000K	400lm
203853	Lampa stołowa TAZA 3,5W 400lm 3000K - 5000K czarna	3,5W	3000K - 5000K	400lm
204430	Lampa stołowa TAZA 3,5W 400lm 3000K - 5000K zielona	3,5W	3000K - 5000K	400lm
204447	Lampa stołowa TAZA 3,5W 400lm 3000K - 5000K pastelowa różowa	3,5W	3000K - 5000K	400lm
208971	Lampa stołowa TAZA 3,5W 400lm 3000K - 5000K złota	3,5W	3000K - 5000K	400lm
208694	Lampa stołowa TAZA 3,5W 400lm 3000K - 5000K żółta	3,5W	3000K - 5000K	400lm

okrągła konstrukcja,
oświetlenie 360 stopni



funkcja
ściemnienia



sterowanie
dotykowe



DEKORACYJNE
CAMELIA

uniwersalne
ładowanie USB C

alumiowa
obudowa

zmiana barwy
światła

3000K / 4000K / 5000K

**Lampa stołowa CAMELIA 2,5W CCT 4000mAh
IP20**

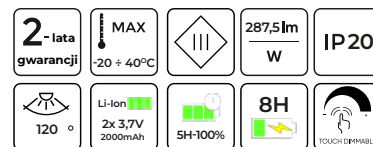
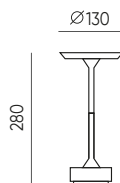

204423

LED line LITE

SYMBOL	NAZWA	MOC	TEMPERATURA BARWOWA	STRUMIEŃ ŚWIETLNY
204423	Lampa stołowa CAMELIA 2,5W 250lm 3000K - 5000K czarna	2,5W	3000K - 5000K	250
204454	Lampa stołowa CAMELIA 2,5W 250lm 3000K - 5000K srebrna	2,5W	3000K - 5000K	250
204461	Lampa stołowa CAMELIA 2,5W 250lm 3000K - 5000K złota	2,5W	3000K - 5000K	250

lekka
i przenośna

funkcja
ściemniania

sterowanie
dotykowe



DEKORACYJNE
RIWIA

zmiana barwy światła

3000K / 4000K / 5000K

**Lampa stołowa RIWIA 1,0W CCT 1800mAh
IP20**

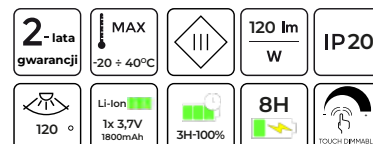
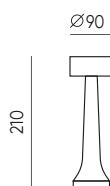

204492

LED line LITE

SYMBOL	NAZWA	MOC	TEMPERATURA BARWOWA	STRUMIEŃ ŚWIETLNY
204492	Lampa stołowa RIWIA 1,0W 120lm 3000K - 5000K złota	1,0W	3000K - 5000K	120
204478	Lampa stołowa RIWIA 1,0W 120lm 3000K - 5000K srebrna	1,0W	3000K - 5000K	120
204485	Lampa stołowa RIWIA 1,0W 120lm 3000K - 5000K różowo złota	1,0W	3000K - 5000K	120



DEKORACYJNE
JUTE

JUTE Oprawa zwieszana sznur 1,5 metra 220-240V



249877

LED line LITE

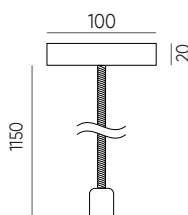
SYMBOL	NAZWA	ILOŚĆ PUNKTÓW ŚWIETLNYCH	DŁUGOŚĆ PRZEDŁUŻENIA	MATERIAŁ	NAPIĘCIE
249877	JUTE Oprawa zwieszana sznur 1.5 metra 1xE27	1	150 cm	sznurek jutowy	220-240VAC
249884	JUTE Oprawa zwieszana sznur 1.5 metra 2xE27	2	150 cm	sznurek jutowy	220-240VAC
249891	JUTE Oprawa zwieszana sznur 1.5 metra 3xE27	3	150 cm	sznurek jutowy	220-240VAC

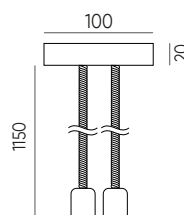

249877



249884

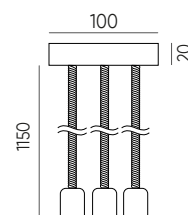

249891



OPRAWKA SUFITOWA
CLASSIC

**Oprawa sufitowa okrągła
czarno-złota**

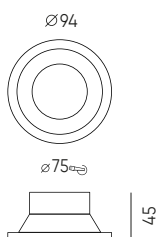

LED line PRIME

SYMBOL	NAZWA	KOLOR OPRAWY	KSZTAŁT	ROZMIAR OTWORU MONTAŻOWEGO	TYP MONTAŻU	MATERIAŁ
241321	Oprawa sufitowa okrągła czarno-złota	złoty i czarny	okrągły	75mm	podtynkowy	aluminium

**Oprawa sufitowa okrągła
biało-złota**

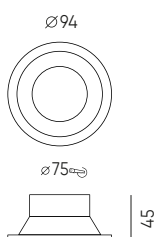

LED line PRIME

SYMBOL	NAZWA	KOLOR OPRAWY	KSZTAŁT	ROZMIAR OTWORU MONTAŻOWEGO	TYP MONTAŻU	MATERIAŁ
241314	Oprawa sufitowa okrągła biało-złota	złoty i biały	okrągły	75mm	podtynkowy	aluminium

Oprawa sufitowa okrągła ruchoma

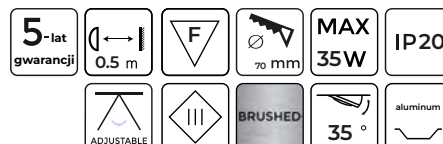
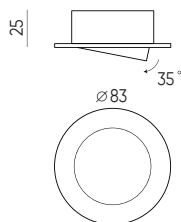

244902

LED line PRIME

SYMBOL	NAZWA	KOLOR OPRAWY	KSZTAŁT	ROZMIAR OTWORU MONTAŻOWEGO	TYP MONTAŻU	CECHA	MATERIAŁ
244902	Oprawa sufitowa okrągła ruchoma czarna szczotkowana	czarny i srebrny	okrągły	70mm	podtynkowy regulowany		aluminium
244810	Oprawa sufitowa okrągła ruchoma srebro szczotkowana	srebrny	okrągły	70mm	podtynkowy regulowany		aluminium
244896	Oprawa sufitowa okrągła ruchoma srebro gres	srebrny	okrągły	70mm	podtynkowy regulowany		aluminium

Oprawa sufitowa okrągła ruchoma SLIM OROSA

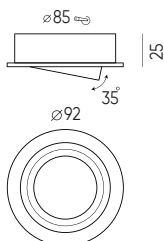

241284

LED line PRIME

SYMBOL	NAZWA	KOLOR OPRAWY	KSZTAŁT	ROZMIAR OTWORU MONTAŻOWEGO	TYP MONTAŻU	CECHA	MATERIAŁ
241284	Oprawa sufitowa okrągła ruchoma SLIM biała szczotkowana OROSA	biały	okrągły	85mm	podtynkowy regulowany		aluminium
241253	Oprawa sufitowa okrągła ruchoma SLIM czarna szczotkowana OROSA	czarny	okrągły	85mm	podtynkowy regulowany		aluminium
241239	Oprawa sufitowa okrągła ruchoma SLIM srebro szczotkowane OROSA	srebrny	okrągły	85mm	podtynkowy regulowany		aluminium

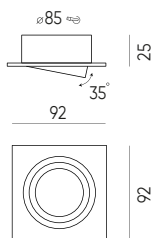
Recessed adjustable square spotlight SLIM AKROS

241208

LED line PRIME

SYMBOL	NAZWA	KOLOR OPRAWY	KSZTAŁT	ROZMIAR OTWORU MONTAŻOWEGO	TYP MONTAŻU	CECHA	MATERIAŁ
241208	Oprawa sufitowa kwadratowa ruchoma SLIM czarna szczotkowana AKROS	czarny	kwadratowy	85mm	podtynkowy	regulowany	aluminium
241215	Oprawa sufitowa kwadratowa ruchoma SLIM srebrno szczotkowane AKROS	srebrny	kwadratowy	85mm	podtynkowy	regulowany	aluminium
241222	Oprawa sufitowa kwadratowa ruchoma SLIM biały mat AKROS	biały	kwadratowy	85mm	podtynkowy	regulowany	aluminium

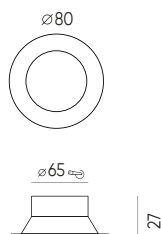
Oprawa sufitowa okrągła odlew

249235

LED line PRIME

SYMBOL	NAZWA	KOLOR OPRAWY	KSZTAŁT	ROZMIAR OTWORU MONTAŻOWEGO	CECHA	MATERIAŁ
249235	Oprawa sufitowa okrągła odlew czarna	czarny	okrągły	65mm	podtynkowy	aluminium
242823	Oprawa sufitowa okrągła odlew satyna	satynowy	okrągły	65mm	podtynkowy	aluminium
242854	Oprawa sufitowa okrągła odlew biała	biały	okrągły	65mm	podtynkowy	aluminium

Oprawa sufitowa okrągła ruchoma odlew

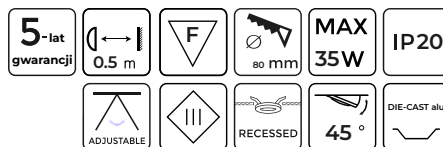
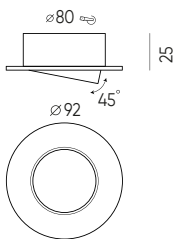

242885

LED line PRIME

SYMBOL	NAZWA	KOLOR OPRAWY	KSZTAŁT	ROZMIAR OTWORU MONTAŻOWEGO	TYP MONTAŻU	CECHA	MATERIAŁ
242885	Oprawa sufitowa okrągła ruchoma odlew satyna	satynowy	okrągły	80mm	podtynkowy	regulowany	aluminium
242915	Oprawa sufitowa okrągła ruchoma odlew biała	biały	okrągły	80mm	podtynkowy	regulowany	aluminium
249259	Oprawa sufitowa okrągła ruchoma odlew czarna	czarny	okrągły	80mm	podtynkowy	regulowany	aluminium

Oprawa sufitowa kwadratowa ruchoma odlew

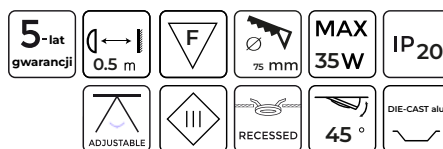
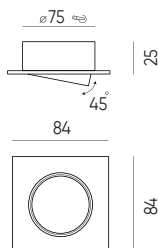

242939

LED line PRIME

SYMBOL	NAZWA	KOLOR OPRAWY	KSZTAŁT	ROZMIAR OTWORU MONTAŻOWEGO	TYP MONTAŻU	CECHA	MATERIAŁ
242939	Oprawa sufitowa kwadratowa ruchoma odlew złota	złoty	kwadratowy	75mm	podtynkowy	regulowany	aluminium
242946	Oprawa sufitowa kwadratowa ruchoma odlew satyna	satynowy	kwadratowy	75mm	podtynkowy	regulowany	aluminium
242977	Oprawa sufitowa kwadratowa ruchoma odlew biała	biały	kwadratowy	75mm	podtynkowy	regulowany	aluminium

Oprawa aluminiowa kwadrat szczotkowana ruchoma

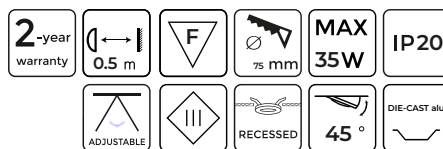
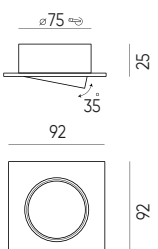

241093

LED line LITE

SYMBOL	NAZWA	KOLOR OPRAWY	KSZTAŁT	ROZMIAR OTWORU MONTAŻOWEGO	TYP MONTAŻU	CECHA	MATERIAŁ
241093	Oprawa aluminiowa kwadrat czarna szczotkowana ruchoma	czarny	kwadratowy	75-80mm	podtynkowy	regulowany	aluminium
240683	Oprawa aluminiowa kwadrat biała szczotkowana ruchoma	biały	kwadratowy	75-80mm	podtynkowy	regulowany	aluminium
240669	Oprawa aluminiowa kwadrat srebrna szczotkowana ruchoma	srebrny	kwadratowy	75-80mm	podtynkowy	regulowany	aluminium



OPRAWKA SUFITOWA
WATERPROOF

Oprawa sufitowa wodoodporna MR11 okrągła

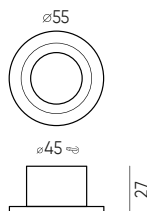
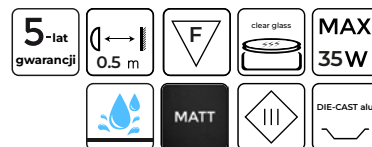

LED line PRIME

249266

SYMBOL	NAZWA	KOLOR OPRAWY	KSZTAŁT	ROZMIAR OTWORU MONTAŻOWEGO	TYP MONTAŻU	CECHA	MATERIAŁ
249266	Oprawa sufitowa wodoodporna MR11 okrągła biała	biały	okrągły	45mm	podtynkowy	wodoodporny	ocynk
249273	Oprawa sufitowa wodoodporna MR11 okrągła chrom	chrom	okrągły	45mm	podtynkowy	wodoodporny	ocynk
249297	Oprawa sufitowa wodoodporna MR11 okrągła czarna	czarny	okrągły	45mm	podtynkowy	wodoodporny	ocynk

Oprawa sufitowa wodoodporna okrągła odlew

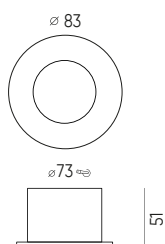

LED line PRIME

245428

SYMBOL	NAZWA	KOLOR OPRAWY	KSZTAŁT	ROZMIAR OTWORU MONTAŻOWEGO	TYP MONTAŻU	CECHA	MATERIAŁ
245428	Oprawa sufitowa wodoodporna okrągła odlew biała	biały	okrągły	73mm	podtynkowy	wodoodporny	aluminium
245435	Oprawa sufitowa wodoodporna okrągła odlew chrom	chrom	okrągły	73mm	podtynkowy	wodoodporny	aluminium
245442	Oprawa sufitowa wodoodporna okrągła odlew satyna	satynowy	okrągły	73mm	podtynkowy	wodoodporny	aluminium
471055	Oprawa sufitowa wodoodporna okrągła odlew czarna	czarny	okrągły	73mm	podtynkowy	wodoodporny	aluminium

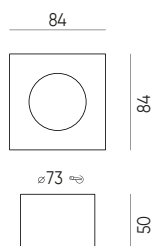
Oprawa sufitowa wodoodporna kwadrat odlew

245374

LED line PRIME

SYMBOL	NAZWA	KOLOR OPRAWY	KSZTAŁT	ROZMIAR OTWORU MONTAŻOWEGO	TYP MONTAŻU	CECHA	MATERIAŁ
245374	Oprawa sufitowa wodoodporna kwadrat odlew biała	biały	kwadratowy	73mm	podtynkowy	wodoodporny	aluminium
245398	Oprawa sufitowa wodoodporna kwadrat odlew satyna	satynowy	kwadratowy	73mm	podtynkowy	wodoodporny	aluminium
471062	Oprawa sufitowa wodoodporna kwadrat odlew czarna	czarny	kwadratowy	73mm	podtynkowy	wodoodporny	aluminium

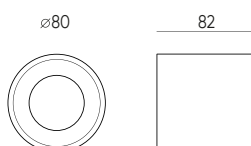
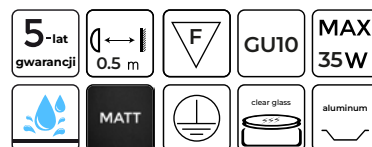
Oprawa natynkowa wodoodporna okrągła TUBE

242540

LED line PRIME

SYMBOL	NAZWA	KOLOR OPRAWY	KSZTAŁT	TYP MONTAŻU	CECHA	MATERIAŁ
242540	Oprawa natynkowa wodoodporna okrągła biała TUBE	biały	okrągły	natynkowy	wodoodporny	aluminium
242557	Oprawa natynkowa wodoodporna okrągła czarna TUBE	czarny	okrągły	natynkowy	wodoodporny	aluminium



OPRAWKA SUFITOWA
ROLLO

**Oprawa wpuszczana okrągła
ROLLO MIDI**

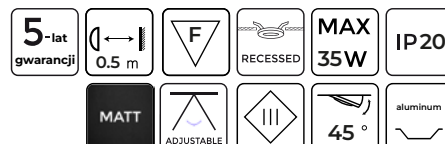
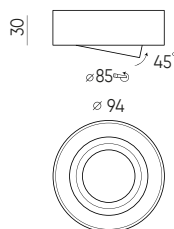

242656

LED line PRIME

SYMBOL	NAZWA	KOLOR OPRAWY	KSZTAŁT	ROZMIAR OTWORU MONTAŻOWEGO	TYP MONTAŻU	CECHA	MATERIAŁ
242656	Oprawa wpuszczana okrągła ruchoma czarna ROLLO MIDI	czarny	okrągły	85mm	podtynkowy	regulowany	aluminium
243851	Oprawa wpuszczana okrągła biała ROLLO MIDI	biały	okrągły	85mm	podtynkowy	regulowany	aluminium
243134	Oprawa wpuszczana okrągła srebro ROLLO MIDI	srebrny	okrągły	85mm	podtynkowy	regulowany	aluminium



OPRAWKA SUFITOWA
CUBO

**Oprawa wpuszczana kwadrat
biała CUBO MIDI**

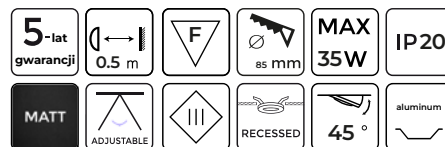
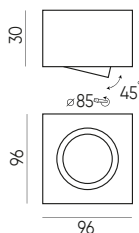

LED line PRIME

SYMBOL	NAZWA	KOLOR OPRAWY	KSZTAŁT	ROZMIAR OTWORU MONTAŻOWEGO	CECHA	MATERIAŁ
243141	Oprawa wpuszczana kwadrat biała CUBO MIDI	biały	kwadratowy	85mm	podtynkowy	aluminium

**Oprawa natynkowa punktowa
kwadrat biała CUBO**

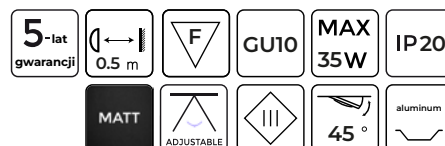
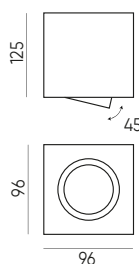

LED line PRIME

SYMBOL	NAZWA	KOLOR OPRAWY	KSZTAŁT	TYP MONTAŻU	CECHA	MATERIAŁ
249723	Oprawa natynkowa punktowa kwadrat biała CUBO	biały	kwadratowy	natynkowy	regulowany	aluminium

**Oprawa natynkowa punktowa
kwadrat srebro CUBO**

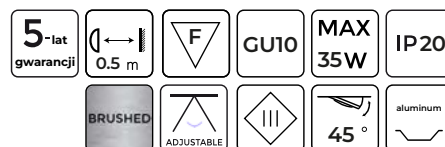
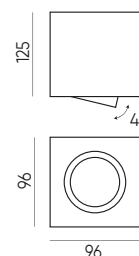

LED line PRIME

SYMBOL	NAZWA	KOLOR OPRAWY	KSZTAŁT	TYP MONTAŻU	CECHA	MATERIAŁ
249747	Oprawa natynkowa punktowa kwadrat srebro CUBO		kwadratowy	natynkowy	regulowany	aluminium



MODUŁ LED
EXPERT

LED Opto moduł 1W IP65

7-year warranty	PWM	Waterproof	70000 h L70B50	0.5 m	F	ON/OFF 50000	95 lm W	IP65
SMD 2835	170°	LED provided by OSRAM	MAX -40 ÷ 55	* IES	PVC	voltage 12V DC	1 LED	

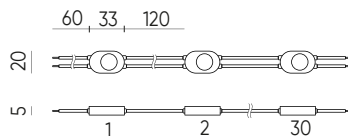

LED line PRIME

SYMBOL	NAZWA	KĄT ŚWIECENIA	MOC	TEMPERATURA BARWOWA	STRUMIEŃ ŚWIETLNY	NAPIĘCIE	LED
243400	LED OPTO moduł 1x SMD2835 12V 6500K 1W IP65	170°	1W	6500K	95lm	12V	SMD2835

LED Opto moduł 2W IP65

7-year warranty	PWM	Waterproof	70000 h L70B50	0.5 m	F	ON/OFF 50000	95 lm W	IP65
SMD 2835	170°	LED provided by OSRAM	MAX -40 ÷ 55	* IES	PVC	voltage 12V DC	2 LED	

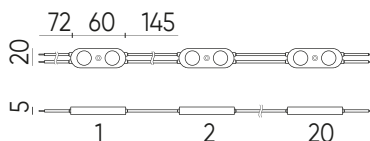

LED line PRIME

SYMBOL	NAZWA	KĄT ŚWIECENIA	MOC	TEMPERATURA BARWOWA	STRUMIEŃ ŚWIETLNY	NAPIĘCIE	LED
243417	LED OPTO moduł 2x SMD2835 12V 6500K 2W IP65	170°	2W	6500K	190lm	12V	SMD2835

LED Opto moduł 2,5W IP65

7-year warranty	PWM	Waterproof	70000 h L70B50	0.5 m	F	ON/OFF 50000	95 lm W	IP65
SMD 2835	170°	LED provided by OSRAM	MAX -40 ÷ 55	* IES	PVC	voltage 12V DC	3 LED	

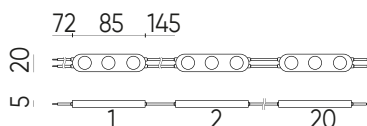

LED line PRIME

SYMBOL	NAZWA	KĄT ŚWIECENIA	MOC	TEMPERATURA BARWOWA	STRUMIEŃ ŚWIETLNY	NAPIĘCIE	LED
243424	LED OPTO moduł 3x SMD2835 12V 6500K 2,5W IP65	170°	2.5W	6500K	237lm	12V	SMD2835

LED Opto moduł 3W IP65

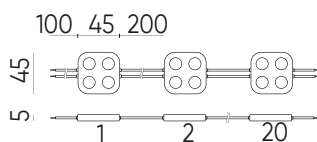
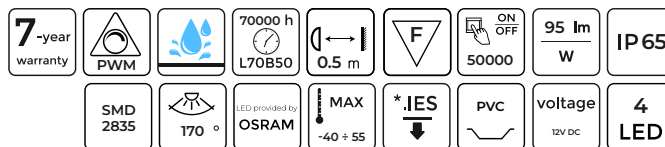

LED line PRIME

SYMBOL	NAZWA	KĄT ŚWIECENIA	MOC	TEMPERATURA BARWOWA	STRUMIENŃ ŚWIETLNY	NAPIĘCIE	LED
243431	LED OPTO moduł 4x SMD2835 12V 6500K 3W IP65	170°	3W	6500K	285lm	12V	SMD2835



KONTROLER LED PILOT

Pilot RF do kontrolera VARIANTE DIM/CCT

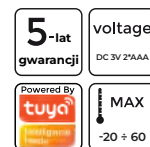
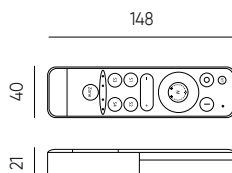

LED line PRIME

SYMBOL	NAZWA	ZASILACZ	ODLEGŁOŚĆ RF	KOMUNIKACJA	FUNKCJA
471321	Pilot RF do kontrolera VARIANTE DIM/CCT	DC 3V 2*AAA	20M	RF 2,4GHz	DIM/CCT

Pilot RF do kontrolera VARIANTE RGB/RGBW

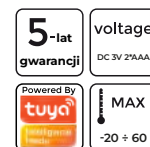
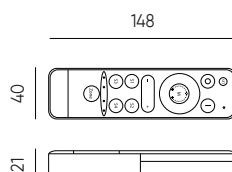

LED line PRIME

SYMBOL	NAZWA	ZASILACZ	ODLEGŁOŚĆ RF	KOMUNIKACJA	FUNKCJA
471338	Pilot RF do kontrolera VARIANTE RGB/RGBW	DC 3V 2*AAA	20M	RF 2,4GHz	RGB/RGBW

MAG JOY Pilot do kontrolera VARIANTE

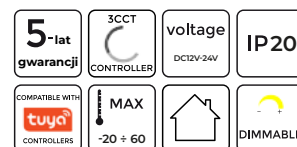
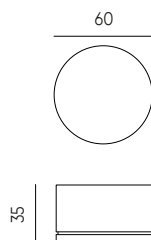

LED line PRIME

SYMBOL	NAZWA	ZASILACZ	ODLEGŁOŚĆ RF	KOMUNIKACJA	FUNKCJA
476937	MAG JOY Pilot do kontrolera VARIANTE	DC 3V 2*AAA	30M	RF 2,4GHz	DIM/CCT

Pilot ścienny RF do kontrolera VARIANTE DIM/CCT

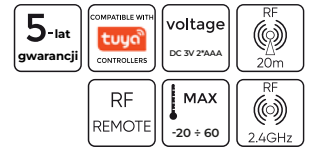

LED line PRIME

SYMBOL	NAZWA	ZASILACZ	ODLEGŁOŚĆ RF	KOMUNIKACJA	FUNKCJA
201200	Pilot ścienny RF do kontrolera VARIANTE DIM/CCT	90-265VAC	20M	RF 2,4GHz	DIM/CCT

Pilot ścienny RF do kontrolera VARIANTE RGB

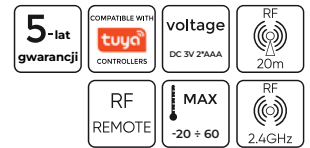

LED line PRIME

SYMBOL	NAZWA	ZASILACZ	ODLEGŁOŚĆ RF	KOMUNIKACJA	FUNKCJA
201217	Pilot ścienny RF do kontrolera VARIANTE RGB	90-265VAC	20M	RF 2,4GHz	RGB

Pilot ścienny RF do kontrolera VARIANTE RGBW/RGBCCT

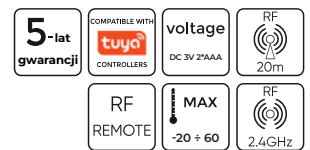

LED line PRIME

SYMBOL	NAZWA	ZASILACZ	ODLEGŁOŚĆ RF	KOMUNIKACJA	FUNKCJA
201224	Pilot ścienny RF do kontrolera VARIANTE RGBW/RGBCCT	DC 3V 2*AAA	20M	RF 2,4GHz	RGBW/RGBCCT

Pilot RF SLIM VARIANTE DIM/CCT/0-10V

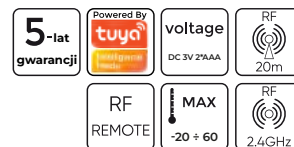

LED line PRIME

SYMBOL	NAZWA	ZASILACZ	ODLEGŁOŚĆ RF	KOMUNIKACJA	FUNKCJA
203600	Pilot RF SLIM VARIANTE DIM/CCT/0-10V	DC 3V 2*AAA	20M	RF 2,4GHz	RGBW/RGBCT



KONTROLER LED VARIANTE

Kontroler VARIANTE LED RF WIFI TUYA 5in1

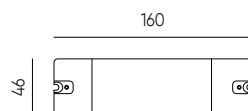

LED line PRIME

SYMBOL	NAZWA	ZASILACZ	MAKS. WYJŚCIE	KOMUNIKACJA	FUNKCJA
477781	Kontroler VARIANTE LED RF WIFI TUYA 5in1	12-24V	20A (4A/channel)	RF 2,4GHz / WIFI	DIM/CCT/RGB/RGBW/RGBCCT

Kontroler VARIANTE RF WIFI TUYA DIM

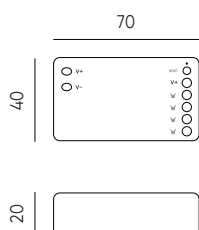

LED line PRIME

SYMBOL	NAZWA	ZASILACZ	MAKS. WYJŚCIE	KOMUNIKACJA	FUNKCJA
471277	Kontroler VARIANTE RF WIFI TUYA DIM	12-24V	16A (4A/channel)	RF 2,4GHz / WIFI	DIM

Kontroler VARIANTE RF WIFI TUYA DIM / CCT

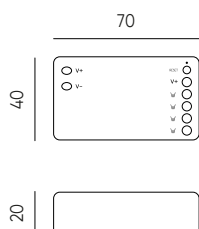

LED line PRIME

SYMBOL	NAZWA	ZASILACZ	MAKS. WYJŚCIE	KOMUNIKACJA	FUNKCJA
471284	Kontroler VARIANTE RF WIFI TUYA DIM / CCT	12-24V	16A (4A/channel)	RF 2,4GHz / WIFI	CCT

Kontroler VARIANTE RF WIFI TUYA RGB

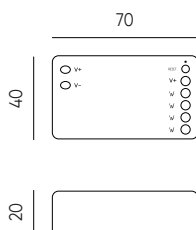

LED line PRIME

SYMBOL	NAZWA	ZASILACZ	MAKS. WYJŚCIE	KOMUNIKACJA	FUNKCJA
471291	Kontroler VARIANTE RF WIFI TUYA RGB	12-24V	15A (5A/channel)	RF 2,4GHz / WIFI	RGB

Kontroler VARIANTE RF WIFI TUYA RGBW

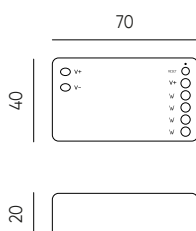

LED line PRIME

SYMBOL	NAZWA	ZASILACZ	MAKS. WYJŚCIE	KOMUNIKACJA	FUNKCJA
471307	Kontroler VARIANTE RF WIFI TUYA RGBW	12-24V	16A (4A/channel)	RF 2,4GHz / WIFI	RGBW

Kontroler VARIANTE RF RGB/RGBW + pilot

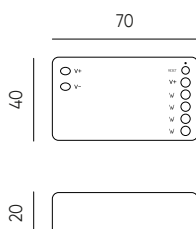

LED line PRIME

SYMBOL	NAZWA	ZASILACZ	MAKS. WYJŚCIE	KOMUNIKACJA	FUNKCJA
471314	Kontroler VARIANTE RF RGB/RGBW + pilot	12-24V	16A (4A/channel RGBW, 5A/channel RGB)	RF 433,92Mhz	RGB/RGBW

VARIANTE Kontroler LED RGCCT

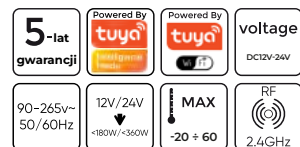

LED line PRIME

SYMBOL	NAZWA	ZASILACZ	MAKS. WYJŚCIE	KOMUNIKACJA	FUNKCJA
201231	Kontroler VARIANTE RF WIFI TUYA RGCCT	12-24V	15A (3A/channel)	RF 2,4GHz / WIFI	RGCCT

VARIANTE Kontroler LED SPI DIGITAL RGB

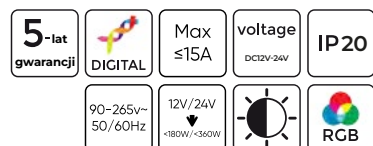

LED line PRIME

SYMBOL	NAZWA	ZASILACZ	MAKS. WYJŚCIE	KOMUNIKACJA	FUNKCJA
201286	Kontroler VARIANTE RF SPI DIGITAL RGB	12-24V	15A (3A/channel)	RF 2,4GHz	SPI DIGITAL



ZASILACZ LED
WATERPROOF

Zasilacz 12W IP67

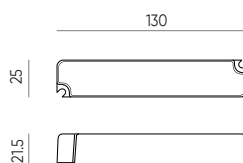
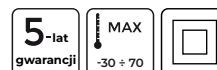

LL-12-12

LED line PRIME

SYMBOL	NAZWA	MOC	NAPIĘCIE	KLASA IP
LL-12-12	Zasilacz 12W IP67 12V	12W	12V	IP67
LL-12-24	Zasilacz 12W IP67 12V	12W	24V	IP67

Zasilacz 20W IP67

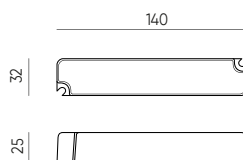
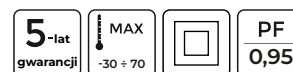

LL-20-12

LED line PRIME

SYMBOL	NAZWA	MOC	NAPIĘCIE	KLASA IP
LL-20-12	Zasilacz 20W IP67 12V	20W	12V	IP67
LL-20-24	Zasilacz 20W IP67 24V	20W	24V	IP67

Zasilacz 36W IP67

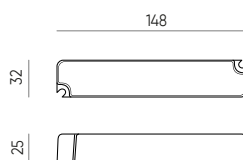
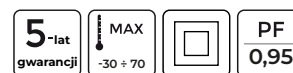

LL-35-12

LED line PRIME

SYMBOL	NAZWA	MOC	NAPIĘCIE	KLASA IP
LL-35-12	Zasilacz 36W IP67 12V	36W	12V	IP67
LL-35-24	Zasilacz 36W IP67 24V	36W	24V	IP67

Zasilacz 50W IP67

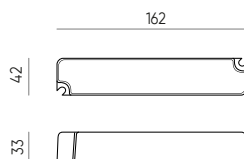

LL-50-12

LED line PRIME

SYMBOL	NAZWA	MOC	NAPIĘCIE	KLASA IP
LL-50-12	Zasilacz 50W IP67 12V	50W	12V	IP67
LL-50-24	Zasilacz 50W IP67 24V	50W	24V	IP67

Zasilacz 60W IP67

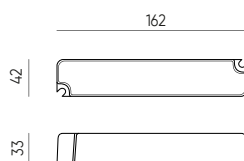

LL-60-12

LED line PRIME

SYMBOL	NAZWA	MOC	NAPIĘCIE	KLASA IP
LL-60-12	Zasilacz 60W IP67 12V	60W	12V	IP67
LL-60-24	Zasilacz 60W IP67 24V	60W	24V	IP67

Zasilacz 75W IP67

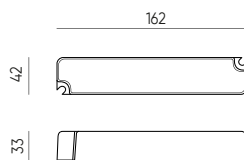

LL-75-12

LED line PRIME

SYMBOL	NAZWA	MOC	NAPIĘCIE	KLASA IP
LL-75-12	Zasilacz 75W IP67 12V	75W	12V	IP67
LL-75-24	Zasilacz 75W IP67 24V	75W	24V	IP67

Zasilacz 100W IP67

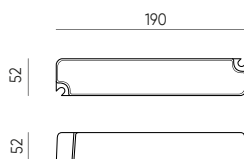

LL-100-12

LED line PRIME

SYMBOL	NAZWA	MOC	NAPIĘCIE	KLASA IP
LL-100-12	Zasilacz 100W IP67 12V	100W	12V	IP67
LL-100-24	Zasilacz 100W IP67 24V	100W	24V	IP67

Zasilacz LED 150W IP67

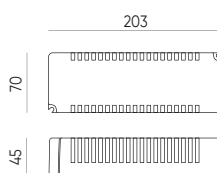

LL-150-12

LED line PRIME

SYMBOL	NAZWA	MOC	NAPIĘCIE	KLASA IP
LL-150-12	Zasilacz 150W IP67 12V	150W	12V	IP67
LL-150-24	Zasilacz 150W IP67 24V	150W	24V	IP67

Zasilacz LED 200W IP67

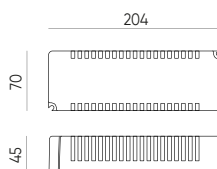

LL-200-12

LED line PRIME

SYMBOL	NAZWA	MOC	NAPIĘCIE	KLASA IP
LL-200-12	Zasilacz 200W IP67 12V	200W	12V	IP67
LL-200-24	Zasilacz 200W IP67 24V	200W	24V	IP67



ZASILACZ LED
MULTIPOWER

LED Multipower sensor Hand Motion

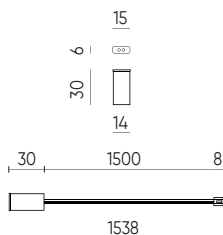

LL-150-12

LED line LITE

SYMBOL	NAZWA	TYP CZUJNIKA
477965	LED Master Sensor Hand Motion On/Off	PROXIMITY
478009	LED Channel Sensor Hand Motion On/Off	PROXIMITY

LED Multipower sensor PIR

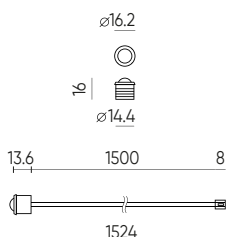

477989

LED line LITE

SYMBOL	NAZWA
477989	LED Master Sensor PIR
478023	LED Channel Sensor PIR

LED Multipower Touch ON/OFF/ DIMMER

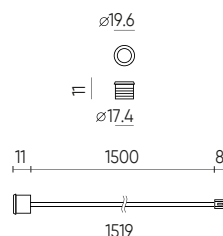

477958

LED line LITE

SYMBOL	NAZWA
477958	LED Master Sensor Touch On/Off Dimmer
477996	LED Channel Sensor Touch On/Off Dimmer

LED Multipower IR Door

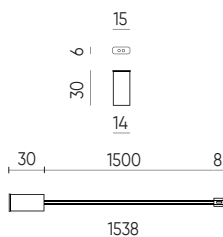

477972

LED line LITE

SYMBOL	NAZWA
477972	LED Master Sensor IR Door
478016	LED Channel Sensor IR Door

LED Multipower driver 60W 12V



LED line LITE

SYMBOL	NAZWA	MOC	NAPIĘCIE	KLASA IP
477736	LED Multipower 60-12 5A 60W 12V IP20	60W	12V	IP20

LED Multipower driver 100W 12V



LED line LITE

SYMBOL	NAZWA	MOC	NAPIĘCIE	KLASA IP
477743	Multipower 100-12 8,3A 100W 12V IP20	100W	12V	IP20

LED Multipower przewód

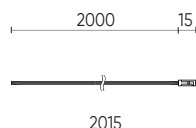

477934

LED line LITE

SYMBOL	NAZWA
477934	Multipower LED Przewód do taśmy 2m
477927	Multipower Przewód przedłużający 2m

LED Multipower splitter

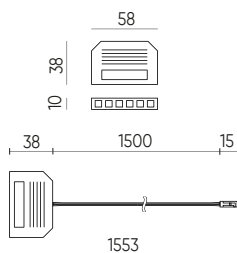

LED line LITE

SYMBOL	NAZWA
477941	LED Multipower Splitter 6 portów

**Profile LED aluminiowe
 nawierzchniowe LED**

LED line PRIME

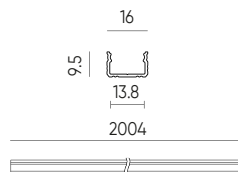

IP20



203617

SYMBOL	NAZWA	MAKS. SZER. TAŚMY	DŁUGOŚĆ	WYS.	SZER.	TYP MONTAŻU	KOLOR
203617	Profil aluminiowy nawierzchniowy 10mm anodowany 2000 mm z mlecznym kloszem	12mm	2000 mm	9,5 mm	16 mm	nawierzchniowy	anodowany
203624	Profil aluminiowy nawierzchniowy 10mm biały 2000 mm z mlecznym kloszem	12mm	2000 mm	9,5 mm	16 mm	nawierzchniowy	biały
203631	Profil aluminiowy nawierzchniowy 10mm czarny 2000 mm z mlecznym kloszem	12mm	2000 mm	9,5 mm	16 mm	nawierzchniowy	czarny

**Profile LED aluminiowe
 narożne LED**

LED line PRIME

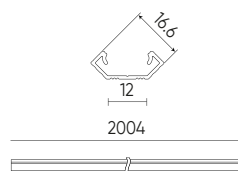

IP20



203648

SYMBOL	NAZWA	MAKS. SZER. TAŚMY	DŁUGOŚĆ	WYS.	SZER.	TYP MONTAŻU	KOLOR
203648	Profil aluminiowy narożny 10mm anodowany 2000 mm z mlecznym kloszem	12mm	2000 mm	16,6mm	16,6mm	narożny	anodowany
203655	Profil aluminiowy narożny 10mm biały 2000 mm z mlecznym kloszem	12mm	2000 mm	16,6mm	16,6mm	narożny	biały
203662	Profil aluminiowy narożny 10mm czarny 2000 mm z mlecznym kloszem	12mm	2000 mm	16,6mm	16,6mm	narożny	czarny

**Profile LED aluminiowe
 wpuszczane LED**

LED line PRIME

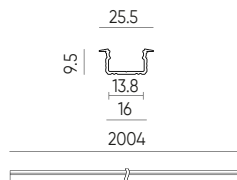

IP20



203679

SYMBOL	NAZWA	MAKS. SZER. TAŚMY	DŁUGOŚĆ	WYS.	SZER.	TYP MONTAŻU	KOLOR
203679	Profil aluminiowy wpuszczany 10mm anodowany 2000 mm z mlecznym kloszem	12mm	2000 mm	9,5 mm	16 mm	wpuszczany	anodowany
203686	Profil aluminiowy wpuszczany 10mm biały 2000 mm z mlecznym kloszem	12mm	2000 mm	9,5 mm	16 mm	wpuszczany	biały
203693	Profil aluminiowy wpuszczany 10mm czarny 2000 mm z mlecznym kloszem	12mm	2000 mm	9,5 mm	16 mm	wpuszczany	czarny



 **LED line**
L A B



Jakość bez kompromisów

Najważniejszym celem LED line LAB jest tworzenie i weryfikacja produktów, tak aby spełniały wszystkie, nawet najbardziej restrykcyjne dyrektywy i normy, które stanowią obowiązujący standard firmy. Ogromna uwaga, z jaką traktujemy jakość produktu, czyli jego bezawaryjność, trwałość i bezpieczeństwo, przynosi efekt w postaci 99,54% zgodności, czyli nasz wskaźnik reklamacji wynosi zaledwie 0,46%.

Badania jakościowe prowadzone są w trybie ciągłym i dotyczą każdej partii produktów – warunkiem dopuszczenia do sprzedaży jest pozytywny i pełny przebieg testu jakościowego. Dzięki temu jesteśmy pewni, że w ręce naszych klientów trafiają produkty, z którymi nie ma problemów ani na etapie sprzedaży, realizacji inwestycji czy użytkowania.

W poszukiwaniu optymalnych rozwiązań

Zadaniem działu R&D jest opracowywanie nowych produktów pod kątem oczekiwań i potrzeb rynku. Przeprowadzany jest pełny proces – od koncepcji, poprzez prototypowanie, aż po produkcję i wdrożenie. Dzięki prowadzonym analizom wiemy, jakie produkty należy wprowadzić, aby oferta LED line była jak najbardziej komplementarna i zoptymalizowana, a tym samym przynosiła wyższy poziom zwrotu z inwestycji.

Wyposażenie na najwyższym dostępnym poziomie

Inwestycje poczynione w LED line LAB umożliwiają nam osiągnięcie najwyższych parametrów jakościowych, co szczególnie doceniają nasi partnerzy biznesowi.



Laboratorium wyposażone zostało w wysokiej klasy urządzenia takie jak:

- Ciemnia fotometryczna wyposażona w goniofotometr
- Stanowisko do badania parametrów świetlnych i radiacyjnych
- Stanowisko do pomiarów kompatybilności elektromagnetycznej EMC
- Stanowisko do testów starzeniowych
- Stanowisko do pomiaru emisji harmonicznych
- Stanowisko do badań termicznych z urządzeniami: 16-kanalowy miernik temperatury oraz kamera termowizyjna
- Stanowisko do badania spadków napięcia taśm LED
- Stanowisko do badania ściemnianych źródeł światła

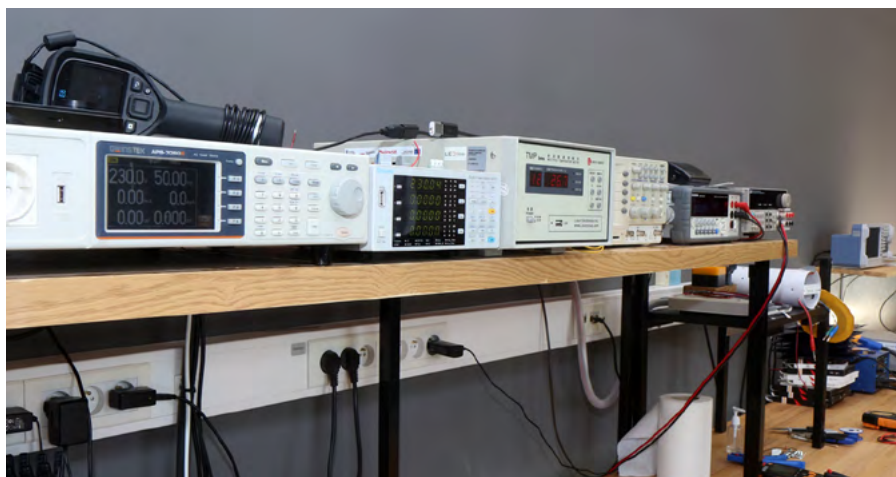

Eksperckie wsparcie dla projektantów

Dzięki możliwości generowania miarodajnych plików IES oraz EULUMDAT współpracujący z nami projektanci mogą tworzyć projekty o wysokim stopniu precyzji, co jest szczególnie cenne, biorąc pod uwagę oczekiwania rynku, w szczególności rynku inwestycyjnego. Generujemy wysokiej jakości pliki fotometryczne, które po zaimportowaniu do programów Dialux lub Relux pozwalają dobrać odpowiedni typ i ilość opraw do każdego rodzaju projektu.

Edukacja, która buduje przyszłość rynku

Rynek LED rozwija się bardzo dynamicznie, a tym samym staje się coraz bardziej wymagający. Naszą misją jest więc nie tylko oferowanie najbardziej efektywnych produktów i rozwiązań, ale także stałe dzielenie się wiedzą i doświadczeniem. Edukacja podnosi poziom oczekiwań rynku, a my jesteśmy gotowi, by im sprostać. Prowadzimy szkolenia dla naszych strategicznych partnerów biznesowych, dystrybutorów, klientów i pracowników.



INDEKS PRODUKTÓW

Symbol	Nazwa produktu	Strona
200203	FLOODLIGHT PRIME 30W 4200lm 4000K 120°	49
200289	FLOODLIGHT PRIME 30W 4200lm 4000K 90°	49
200272	FLOODLIGHT PRIME 30W 4200lm 4000K 60°	49
200265	FLOODLIGHT PRIME 30W 4200lm 4000K 30°	49
202566	FLOODLIGHT PRIME 30W 4200lm 4000K T2	49
202559	FLOODLIGHT PRIME 30W 4200lm 4000K T3	49
202726	FLOODLIGHT PRIME 30W 4200lm CCT 120°	49
202900	FLOODLIGHT PRIME 30W 4200lm CCT 30°	49
202733	FLOODLIGHT PRIME 30W 4200lm CCT T2	49
200210	FLOODLIGHT PRIME 50W 7000lm 4000K 120°	49
200319	FLOODLIGHT PRIME 50W 7000lm 4000K 90°	49
200302	FLOODLIGHT PRIME 50W 7000lm 4000K 60°	49
200296	FLOODLIGHT PRIME 50W 7000lm 4000K 30°	49
202443	FLOODLIGHT PRIME 50W 7000lm 4000K T2	49
202542	FLOODLIGHT PRIME 50W 7000lm 4000K T3	49
202757	FLOODLIGHT PRIME 50W 7000lm CCT 120°	49
202948	FLOODLIGHT PRIME 50W 7000lm CCT 30°	49
202740	FLOODLIGHT PRIME 50W 7000lm CCT T2	49
200227	FLOODLIGHT PRIME 100W 14000lm 4000K 120°	50
200340	FLOODLIGHT PRIME 100W 14000lm 4000K 90°	50
200333	FLOODLIGHT PRIME 100W 14000lm 4000K 60°	50
200326	FLOODLIGHT PRIME 100W 14000lm 4000K 30°	50
202450	FLOODLIGHT PRIME 100W 14000lm 4000K T2	50
202528	FLOODLIGHT PRIME 100W 14000lm 4000K T3	50
202764	FLOODLIGHT PRIME 100W 14000lm CCT 120°	50
202986	FLOODLIGHT PRIME 100W 14000lm CCT 30°	50
202771	FLOODLIGHT PRIME 100W 14000lm CCT T2	50
200647	FLOODLIGHT PRIME 150W 21000lm 4000K 120°	50
202610	FLOODLIGHT PRIME 150W 21000lm 4000K 90°	50
200654	FLOODLIGHT PRIME 150W 21000lm 4000K 60°	50
202603	FLOODLIGHT PRIME 150W 21000lm 4000K 30°	50
202580	FLOODLIGHT PRIME 150W 21000lm 4000K T2	50
202627	FLOODLIGHT PRIME 150W 21000lm 4000K T3	50
202788	FLOODLIGHT PRIME 150W 21000lm CCT 120°	50
203020	FLOODLIGHT PRIME 150W 21000lm CCT 30°	50
202795	FLOODLIGHT PRIME 150W 21000lm CCT T2	50
200418	FLOODLIGHT PRIME 400W 56000lm 4000K T3	51
200234	FLOODLIGHT PRIME 200W 28000lm 4000K 120°	51
200371	FLOODLIGHT PRIME 200W 28000lm 4000K 90°	51
200364	FLOODLIGHT PRIME 200W 28000lm 4000K 60°	51
200357	FLOODLIGHT PRIME 200W 28000lm 4000K 30°	51
202467	FLOODLIGHT PRIME 200W 28000lm 4000K T2	51
202535	FLOODLIGHT PRIME 200W 28000lm 4000K T3	51
202801	FLOODLIGHT PRIME 200W 28000lm CCT 120°	51
203068	FLOODLIGHT PRIME 200W 28000lm CCT 30°	51
202818	FLOODLIGHT PRIME 200W 28000lm CCT T2	51
200241	FLOODLIGHT PRIME 400W 56000lm 4000K 120°	51
202689	FLOODLIGHT PRIME 400W 56000lm 4000K 90°	51
202672	FLOODLIGHT PRIME 400W 56000lm 4000K 60°	51
202665	FLOODLIGHT PRIME 400W 56000lm 4000K 30°	51
200401	FLOODLIGHT PRIME 400W 56000lm 4000K T2	51
202696	FLOODLIGHT PRIME 600W 4000K 84000lm T3	52

Symbol	Nazwa produktu	Strona
200258	FLOODLIGHT PRIME 600W 4000K 84000lm 120°	52
202658	FLOODLIGHT PRIME 600W 4000K 84000lm 90°	52
202641	FLOODLIGHT PRIME 600W 4000K 84000lm 60°	52
202634	FLOODLIGHT PRIME 600W 4000K 84000lm 30°	52
202597	FLOODLIGHT PRIME 600W 4000K 84000lm T2	52
203495	Naświetlacz PHOTON 10W 1000lm 4000K	54
203518	Naświetlacz PHOTON 20W 2000lm 4000K	54
203525	Naświetlacz PHOTON 30W 3000lm 4000K	54
203549	Naświetlacz PHOTON 50W 5000lm 4000K	54
203563	Naświetlacz PHOTON 100W 10000lm 4000K	55
203501	Naświetlacz PHOTON 10W 1000lm 4000K z czujnikiem ruchu	55
203488	Naświetlacz PHOTON 20W 2000lm 4000K z czujnikiem ruchu	56
203532	Naświetlacz PHOTON 30W 3000lm 4000K z czujnikiem ruchu	56
203556	Naświetlacz PHOTON 50W 5000lm 4000K z czujnikiem ruchu	56
203747	Naświetlacz PHOTON 100W 10000lm 4000K z czujnikiem ruchu	57
470492	Naświetlacz PHOTON 50W RGB	57
476999	Naświetlacz PHOTON 10W 800lm 6000K AC z czujnikiem ruchu	58
477019	Naświetlacz PHOTON 30W 2400lm 6000K AC z czujnikiem ruchu	58
477026	Naświetlacz PHOTON 50W 4000lm 6000K AC z czujnikiem ruchu	58
203280	Naświetlacz LUMINO 10W 1000lm 4000K	60
203297	Naświetlacz LUMINO 20W 2000lm 4000K	60
203303	Naświetlacz LUMINO 30W 3000lm 4000K	60
203310	Naświetlacz LUMINO 50W 5000lm 4000K	61
203327	Naświetlacz LUMINO 100W 10000lm 4000K	61
203334	Naświetlacz LUMINO 150W 15000lm 4000K	61
203341	Naświetlacz LUMINO 200W 20000lm 4000K	62
203358	Naświetlacz LUMINO 10W 1000lm 4000K z czujnikiem ruchu	62
203365	Naświetlacz LUMINO 20W 2000lm 4000K z czujnikiem ruchu	62
203372	Naświetlacz LUMINO 30W 3000lm 4000K z czujnikiem ruchu	63
203389	Naświetlacz LUMINO 50W 5000lm 4000K z czujnikiem ruchu	63
206588	High bay PHANTOM 190 70W 13300lm 4000K 1-10V	67
206595	High bay PHANTOM 190 70W 13300lm 4000K 1-10V	67
206601	High bay PHANTOM 190 70W 13300lm 4000K 1-10V	67
203143	High bay PHANTOM 190 100W 19000lm 4000K 1-10V	67
203150	High bay PHANTOM 190 100W 19000lm 4000K 1-10V	67
203167	High bay PHANTOM 190 100W 19000lm 4000K 1-10V	67
203174	High bay PHANTOM 190 150W 28500lm 4000K 1-10V	67
203181	High bay PHANTOM 190 150W 28500lm 4000K 1-10V	67
203198	High bay PHANTOM 190 150W 28500lm 4000K 1-10V	67
203204	High bay PHANTOM 190 200W 38000lm 4000K 1-10V	68

Symbol	Nazwa produktu	Strona	Symbol	Nazwa produktu	Strona
203211	High bay PHANTOM 190 200W 38000lm 4000K 1-10V	68	201361	PLAFON IP44 12W 900lm 3000K z czujnikiem ruchu	87
203228	High bay PHANTOM 190 200W 38000lm 4000K 1-10V	68	201378	PLAFON IP44 12W 960lm 4000K	87
207004	High bay PHANTOM 190 100W 19000lm 4000K 1-10V z czujnikiem ruchu	68	201385	PLAFON IP44 12W 960lm 4000K z czujnikiem ruchu	87
207011	High bay PHANTOM 190 100W 19000lm 4000K 1-10V z czujnikiem ruchu	68	201392	PLAFON IP44 18W 1450lm 3000K	88
207028	High bay PHANTOM 190 100W 19000lm 4000K 1-10V z czujnikiem ruchu	68	201408	PLAFON IP44 18W 1450lm 3000K z czujnikiem ruchu	88
207035	High bay PHANTOM 190 150W 28500lm 4000K 1-10V z czujnikiem ruchu	69	201415	PLAFON IP44 18W 1550lm 4000K	88
207042	High bay PHANTOM 190 150W 28500lm 4000K 1-10V z czujnikiem ruchu	69	201422	PLAFON IP44 18W 1550lm 4000K z czujnikiem ruchu	88
207059	High bay PHANTOM 190 150W 28500lm 4000K 1-10V z czujnikiem ruchu	69	201439	PLAFON IP44 24W 1950lm 4000K	89
207066	High Bay PHANTOM 190 200W 38000lm 4000K 1-10V z czujnikiem ruchu	69	201446	PLAFON IP44 24W 1950lm 4000K z czujnikiem ruchu	89
207073	High Bay PHANTOM 190 200W 38000lm 4000K 1-10V z czujnikiem ruchu	69	245497	Plafon BULKHEAD 12W 840lm 4000K	89
207080	High Bay PHANTOM 190 200W 38000lm 4000K 1-10V z czujnikiem ruchu	69	471109	Tri-proof RANGER C lamp 40W 5600lm 4000K IP66	93
470935	High bay UFO RAIDER 130 100W 13000lm 4000K	73	201262	Tri-proof RANGER C 40W 6800lm 4000K 1-10V	93
470966	High bay UFO RAIDER 150W 19500lm 4000K	73	479587	Tri-proof LINKER 21W 3150lm 4000K 150lm/W 220-240V IP65	96
244339	High bay UFO T-Series 100-277V 100W 15000lm 4000K DIM	73	203709	Tri-proof LINKER 30W 4500lm 4000K 150lm/W 220-240V IP65	96
203396	High bay ECOBEAM 100W 10000lm 4000K	75	479594	Tri-proof LINKER 40W 6000lm 4000K 150lm/W 220-240V IP65	96
203402	High bay ECOBEAM 150W 15000lm 4000K	75	201279	Tri-proof LINKER 40W 6000lm 5000K 150lm/W IP65	97
203419	High bay ECOBEAM 200W 20000lm 4000K	75	203754	Tri-proof LINKER 40W 6000lm 4000K 150lm/W IP65 czarny	97
206748	High bay STREAKBAY 50W 5000lm 4000K	78	201057	Tri-proof LINKER 80W 12000lm 4000K 150lm/W IP65	97
206755	High bay STREAKBAY 100W 10000lm 4000K	78	477606	TRI-PROOF 30W 4000K 3600lm 650mm	99
206762	High bay STREAKBAY 150W 15000lm 4000K	78	477644	TRI-PROOF 30W 4000K 3600lm 650mm z czujnikiem ruchu	99
206779	High bay STREAKBAY 200W 20000lm 4000K	79	477613	TRI-PROOF 40W 4000K 4800lm 1250mm	99
206786	Linki stalowe	79	477651	TRI-PROOF 40W 4000K 4800lm 1250mm z czujnikiem ruchu	99
470577	Plafon LUNAR 16W 1360lm 4000K	81	477620	TRI-PROOF 70W 4000K 8400lm 1550mm	99
470591	Plafon LUNAR 22W 1870lm 4000K	81	477637	TRI-PROOF 90W 4000K 10800lm 1550mm	99
470584	Plafon LUNAR 16W 1360lm 4000K z czujnikiem ruchu	81	207134	Oprawa parkowa NOLINA 60W 4000K 9000lm	101
470607	Plafon LUNAR 22W 1870lm 4000K z czujnikiem ruchu	82	207127	Oprawa parkowa NOLINA 30W 4000K 4500lm	101
470577-II	Plafon LUNAR 16W 1600lm 4000K IP65	82	207462	Oprawa parkowa PARKLITE 50-80-100W CCT 6000-12000lm 4000K czarna	103
470591-II	Plafon LUNAR 22W 2200lm 4000K IP65	82	209824	Oprawa parkowa PARKLITE 50-80-100W CCT 6000-12000lm 4000K szara	103
470584-II	Plafon LUNAR 16W 1600lm 4000K IP65 z czujnikiem ruchu	83	207479	Oprawa parkowa PARKLITE 80-100-120W CCT 9600-14400lm 3000-4000-6500K czarna	103
470607-II	Plafon LUNAR 22W 2200lm 4000K IP65 z czujnikiem ruchu	83	209831	Oprawa parkowa PARKLITE 80-100-120W CCT 9600-14400 lm 3000-4000-6500K szara	103
201095	Plafon ACTON 18W 1900lm 3000K IP54 okrągły	85	207486	Oprawa parkowa PARKLITE 50W CCT 6000lm 3000-4000-6500K czarna	103
201101	Plafon ACTON 18W 1900lm 3000K IP54 okrągły z czujnikiem ruchu	85	209848	Oprawa parkowa PARKLITE 50W CCT 6000lm 3000-4000-6500K czarna	103
201118	Plafon ACTON 18W 2000lm 4000K IP54 okrągły	85	475473	Oprawa drogowa ELIDA 40W 4800lm 4000K 120lm/W 100-277V AC T3	105
201125	Plafon ACTON 18W 2000lm 4000K IP54 okrągły z czujnikiem ruchu	85	478498	Oprawa drogowa ELIDA 70W 8400lm 4000K 120lm/W 100-277V AC T3	105
201132	Plafon ACTON 24W 2600lm 4000K IP54 okrągły	85	203105	Oprawa drogowa CAMINO 50W 7000lm 4000K	107
201149	Plafon ACTON 24W 2600lm 4000K IP54 okrągły z czujnikiem ruchu	85	206564	Oprawa drogowa CAMINO 50W 6500lm 3000K	107
201156	Plafon ACTON 18W 1900lm 3000K IP54 kwadratowa	85	203112	Oprawa drogowa CAMINO 100W 14000lm 4000K	107
201163	Plafon ACTON 18W 1900lm 3000K IP54 kwadratowa z czujnikiem ruchu	85	206571	Oprawa drogowa CAMINO 100W 13000lm 3000K	107
201170	Plafon ACTON 18W 2000lm 4000K IP54 kwadratowa	85	203129	Oprawa drogowa CAMINO 150W 21000lm 4000K	107
201187	Plafon ACTON 18W 2000lm 4000K IP54 kwadratowa z czujnikiem ruchu	85	203136	Oprawa drogowa CAMINO 200W 28000lm 4000K	107
201354	PLAFON IP4412W 900lm 3000K	87			

Symbol	Nazwa produktu	Strona
203785	Oprawa drogowa FLAMINGO 30W 4000K 3000lm szara	110
206960	Oprawa drogowa FLAMINGO 30W 4000K 3000lm z czujnikiem zmierzchu szara	110
203792	Oprawa drogowa FLAMINGO 50W 4000K 5000lm szara	110
206977	Oprawa drogowa FLAMINGO 50W 4000K 5000lm z czujnikiem zmierzchu szara	110
203808	Oprawa drogowa FLAMINGO 100W 4000K 10000lm szara	110
206984	Oprawa drogowa FLAMINGO 100W 4000K 10000lm z czujnikiem zmierzchu szara	110
203815	Oprawa drogowa FLAMINGO 30W 3000lm 4000K czarna	111
203822	Oprawa drogowa FLAMINGO 50W 5000lm 4000K czarna	111
203839	Oprawa drogowa FLAMINGO 100W 10000lm 4000K czarna	111
201064	Oprawa drogowa STREETLITE 50W 5000lm 4000K szara	113
201071	Oprawa drogowa STREETLITE 100W 10000lm 4000K szara	113
201088	Oprawa drogowa STREETLITE 150W 15000lm 4000K szara	113
203716	Oprawa drogowa STREETLITE 50W 5000lm 4000K czarna	113
203723	Oprawa drogowa STREETLITE 100W 10000lm 4000K czarna	113
206618	Składany słup oświetleniowy	115
206632	Wspornik naświetlacza	118
206625	Przedłużenie słupa 1m	118
206649	Rama stalowa 180mm	118
478146	Kinkiet zewnętrzny CUBE 2x3W 450lm 3000K czarny	121
478153	Kinkiet zewnętrzny CUBE 2x3W 450lm 3000K biały	121
478160	inkiet zewnętrzny CUBE 2x3W 450lm 3000K szary	121
478177	Kinkiet zewnętrzny CUBE 2x3W 450lm 4000K czarny	121
478184	Kinkiet zewnętrzny CUBE 2x3W 450lm 4000K biały	121
478191	inkiet zewnętrzny CUBE 2x3W 450lm 4000K szary	121
475510	Kinkiet zewnętrzny CILINDER 2x3W 450lm 3000K czarny	121
475527	Kinkiet zewnętrzny CILINDER 2x3W 450lm 3000K biały	121
475534	inkiet zewnętrzny CILINDER 2x3W 450lm 3000K szary	121
475541	Kinkiet zewnętrzny CILINDER 2x3W 450lm 4000K czarny	121
475558	Kinkiet zewnętrzny CILINDER 2x3W 450lm 4000K biały	121
475565	inkiet zewnętrzny CILINDER 2x3W 450lm 4000K szary	121
475466	Oprawa liniowa FUSION 20W 2600lm 4000K PC Cover 120° czarna	126
475480	Oprawa liniowa FUSION 20W 2600lm 4000K 30°90° czarna	126
475497	Oprawa liniowa FUSION 20W 2600lm 4000K 60°110° czarna	126
475503	Oprawa liniowa FUSION 20W 2600lm 4000K 90°110° czarna	126
475602	Oprawa liniowa FUSION 20W 2600lm 4000K 120°120° czarna	126
475619	Oprawa liniowa FUSION 20W 2600lm 4000K LR40 czarna	126

Symbol	Nazwa produktu	Strona
475626	Oprawa liniowa FUSION 20W 2600lm 4000K P18 czarna	126
475633	Oprawa liniowa FUSION 20W 2600lm 4000K 0-10V PC Cover 120° czarna	126
475640	Oprawa liniowa FUSION 20W 2600lm 4000K 0-10V 30°90° czarna	126
475657	Oprawa liniowa FUSION 20W 2600lm 4000K 0-10V 60°110° czarna	126
475664	Oprawa liniowa FUSION 20W 2600lm 4000K 0-10V 90°110° czarna	126
475701	Oprawa liniowa FUSION 20W 2600lm 4000K 0-10V 120°120° czarna	126
475718	Oprawa liniowa FUSION 20W 2600lm 4000K 0-10V LR40 czarna	126
475725	Oprawa liniowa FUSION 20W 2600lm 4000K 0-10V P18 czarna	126
475732	Oprawa liniowa FUSION 40W 5200lm 4000K PC Cover 120° czarna	127
475749	Oprawa liniowa FUSION 40W 5200lm 4000K 30°90° czarna	127
475756	Oprawa liniowa FUSION 40W 5200lm 4000K 60°110° czarna	127
475763	Oprawa liniowa FUSION 40W 5200lm 4000K 90°110° czarna	127
475800	Oprawa liniowa FUSION 40W 5200lm 4000K 120°120° czarna	127
475817	Oprawa liniowa FUSION 40W 5200lm 4000K LR40 czarna	127
475824	Oprawa liniowa FUSION 40W 5200lm 4000K P18 czarna	127
475831	Oprawa liniowa FUSION 40W 5200lm 4000K 0-10V PC Cover 120° czarna	127
475848	Oprawa liniowa FUSION 40W 5200lm 4000K 0-10V 30°90° czarna	127
475855	Oprawa liniowa FUSION 40W 5200lm 4000K 0-10V 60°110° czarna	127
475862	Oprawa liniowa FUSION 40W 5200lm 4000K 0-10V 90°110° czarna	127
475909	Oprawa liniowa FUSION 40W 5200lm 4000K 0-10V 120°120° czarna	127
475916	Oprawa liniowa FUSION 40W 5200lm 4000K 0-10V LR40 czarna	127
475923	Oprawa liniowa FUSION 40W 5200lm 4000K 0-10V P18 czarna	127
475930	Oprawa liniowa FUSION 60W 7800lm 4000K PC Cover 120° czarna	128
475947	Oprawa liniowa FUSION 60W 7800lm 4000K 30°90° czarna	128
475954	Oprawa liniowa FUSION 60W 7800lm 4000K 60°110° czarna	128
475961	Oprawa liniowa FUSION 60W 7800lm 4000K 90°110° czarna	128
476012	Oprawa liniowa FUSION 60W 7800lm 4000K 120°120° czarna	128
476029	Oprawa liniowa FUSION 60W 7800lm 4000K LR40 czarna	128
478962	Oprawa liniowa FUSION 60W 7800lm 4000K P18 czarna	128
478979	Oprawa liniowa FUSION 60W 7800lm 4000K 0-10V PC Cover 120° czarna	128
478986	Oprawa liniowa FUSION 60W 7800lm 4000K 0-10V 30°90° czarna	128
478993	Oprawa liniowa FUSION 60W 7800lm 4000K 0-10V 60°110° czarna	128
479006	Oprawa liniowa FUSION 60W 7800lm 4000K 0-10V 90°110° czarna	128
479662	Oprawa liniowa FUSION 60W 7800lm 4000K 0-10V 120°120° czarna	128
479679	Oprawa liniowa FUSION 60W 7800lm 4000K 0-10V LR40 czarna	128

Symbol	Nazwa produktu	Strona	Symbol	Nazwa produktu	Strona
479686	Oprawa liniowa FUSION 60W 7800lm 4000K 0-10V P18 czarna	128	204270	Oprawa liniowa FUSION 60W 7800lm 4000K P18 biała	131
203259	Oprawa liniowa FUSION 20W 2600lm 4000K PC Cover 120° biała	129	205581	Oprawa liniowa FUSION 60W 7800lm 4000K 0-10V PC Cover 120° biała	131
203983	Oprawa liniowa FUSION 20W 2600lm 4000K 30*90° biała	129	204287	Oprawa liniowa FUSION 60W 7800lm 4000K 0-10V 30*90° biała	131
203990	Oprawa liniowa FUSION 20W 2600lm 4000K 60*110° biała	129	204294	Oprawa liniowa FUSION 60W 7800lm 4000K 0-10V 60*110° biała	131
204003	Oprawa liniowa FUSION 20W 2600lm 4000K 90*110° biała	129	204300	Oprawa liniowa FUSION 60W 7800lm 4000K 0-10V 90*110° biała	131
204010	Oprawa liniowa FUSION 20W 2600lm 4000K 120*120° biała	129	204317	Oprawa liniowa FUSION 60W 7800lm 4000K 0-10V 120*120° biała	131
204027	Oprawa liniowa FUSION 20W 2600lm 4000K LR40 biała	129	204324	Oprawa liniowa FUSION 60W 7800lm 4000K 0-10V LR40 biała	131
204034	Oprawa liniowa FUSION 20W 2600lm 4000K P18 biała	129	204331	Oprawa liniowa FUSION 60W 7800lm 4000K 0-10V P18 biała	131
204041	Oprawa liniowa FUSION 20W 2600lm 4000K 0-10V PC Cover 120° biała	129	203587	FUSION osłona przeciwolśnieniowa UGR<19 czarny	132
204508	Oprawa liniowa FUSION 20W 2600lm 4000K 0-10V 30*90° biała	129	203570	FUSION osłona przeciwolśnieniowa UGR<19 biała	132
204058	Oprawa liniowa FUSION 20W 2600lm 4000K 0-10V 60*110° biała	129	479709	FUSION łącznik przegubowy czarny	132
204065	Oprawa liniowa FUSION 20W 2600lm 4000K 0-10V 90*110° biała	129	203426	FUSION łącznik przegubowy biały	132
204072	Oprawa liniowa FUSION 20W 2600lm 4000K 0-10V 120*120° biała	129	204553	FUSION L łącznik czarny	132
204089	Oprawa liniowa FUSION 20W 2600lm 4000K 0-10V LR40 biała	129	204560	FUSION L łącznik biały	132
204096	Oprawa liniowa FUSION 20W 2600lm 4000K 0-10V P18 biała	129	476821	Taśma LED 320 COB 24V 2700K 8W	134
203266	Oprawa liniowa FUSION 40W 5200lm 4000K PC Cover 120° biała	130	476838	Taśma LED 320 COB 24V 4000K 8W	134
204102	Oprawa liniowa FUSION 40W 5200lm 4000K 30*90° biała	130	476845	Taśma LED 320 COB 24V 6500K 8W	134
204119	Oprawa liniowa FUSION 40W 5200lm 4000K 60*110° biała	130	479754	Taśma LED 320 COB 24V 2700K 8W 30m	134
204126	Oprawa liniowa FUSION 40W 5200lm 4000K 90*110° biała	130	479761	Taśma LED 320 COB 24V 4000K 8W 30m	134
204133	Oprawa liniowa FUSION 40W 5200lm 4000K 120*120° biała	130	479778	Taśma LED 320 COB 24V 6500K 8W 30m	134
204140	Oprawa liniowa FUSION 40W 5200lm 4000K LR40 biała	130	479785	Taśma LED 480 COB 24V 2700K 11W	134
204157	Oprawa liniowa FUSION 40W 5200lm 4000K P18 biała	130	479792	Taśma LED 480 COB 24V 4000K 11W	134
205574	Oprawa liniowa FUSION 40W 5200lm 4000K 0-10V PC Cover 120° biała	130	479808	Taśma LED 480 COB 24V 6500K 11W	134
204164	Oprawa liniowa FUSION 40W 5200lm 4000K 0-10V 30*90° biała	130	200005	Taśma LED 480 COB 24V 2700K 11W 30m	134
204171	Oprawa liniowa FUSION 40W 5200lm 4000K 0-10V 60*110° biała	130	200012	Taśma LED 480 COB 24V 4000K 11W 30m	134
204188	Oprawa liniowa FUSION 40W 5200lm 4000K 0-10V 90*110° biała	130	200029	Taśma LED 480 COB 24V 6500K 11W 30m	134
204195	Oprawa liniowa FUSION 40W 5200lm 4000K 0-10V 120*120° biała	130	479846	Taśma LED 528 COB 24V 2700K 14W	134
204201	Oprawa liniowa FUSION 40W 5200lm 4000K 0-10V LR40 biała	130	479853	Taśma LED 528 COB 24V 4000K 14W	134
204218	Oprawa liniowa FUSION 40W 5200lm 4000K 0-10V P18 biała	130	479860	Taśma LED 528 COB 24V 6500K 14W	134
203273	Oprawa liniowa FUSION 60W 7800lm 4000K PC Cover 120° biała	131	200036	Taśma LED 528 COB 24V 2700K 14W 30m	134
204225	Oprawa liniowa FUSION 60W 7800lm 4000K 30*90° biała	131	200043	Taśma LED 528 COB 24V 4000K 14W 30m	134
204232	Oprawa liniowa FUSION 60W 7800lm 4000K 60*110° biała	131	200050	Taśma LED 528 COB 24V 6500K 14W 30m	134
204249	Oprawa liniowa FUSION 60W 7800lm 4000K 90*110° biała	131	478245	Taśma LED 480 COB 24V 2700K 18W	134
204256	Oprawa liniowa FUSION 60W 7800lm 4000K 120*120° biała	131	478269	Taśma LED 480 COB 24V 4000K 18W	134
204263	Oprawa liniowa FUSION 60W 7800lm 4000K LR40 biała	131	478313	Taśma LED 480 COB 24V 6500K 18W	134
			200098	Taśma LED 480 COB 24V 2700K 18W 30m	134
			200104	Taśma LED 480 COB 24V 4000K 18W 30m	134
			200111	Taśma LED 480 COB 24V 6500K 18W 30m	134
			479907	Taśma LED 576 COB 24V RGB 10W	135
			479921	Taśma LED 576 COB 24V RGB 10W 30m	135
			200173	Taśma LED 840 COB 24V RGB CCT 18W	135
			479723	Taśma LED 320 COB 24V 2700K 8W IP66	136
			479730	Taśma LED 320 COB 24V 4000K 8W IP66	136
			479747	Taśma LED 320 COB 24V 6500K 8W IP66	136
			479815	Taśma LED 480 COB 24V 2700K 11W IP66	136
			479822	Taśma LED 480 COB 24V 4000K 11W IP66	136
			479839	Taśma LED 480 COB 24V 6500K 11W IP66	136
			479877	Taśma LED 528 COB 24V 2700K 14W IP66	136
			479884	Taśma LED 528 COB 24V 4000K 14W IP66	136
			479891	Taśma LED 528 COB 24V 6500K 14W IP66	136
			479914	Taśma LED 576 COB 24V RGB 10W IP66	136

Symbol	Nazwa produktu	Strona
479945	Taśma LED 128 SMD2835 24V 2700K IP20 8,5W 160lm/W	138
479952	Taśma LED 128 SMD2835 24V 4000K IP20 8,5W 160lm/W	138
479969	Taśma LED 192 SMD2835 24V 2700K IP20 17,5W 160lm/W	138
479976	Taśma LED 192 SMD2835 24V 4000K IP20 17,5W 160lm/W	138
479983	Taśma LED 144 SMD2835 24V 2700K IP20 6,5W 200lm/W	138
479990	Taśma LED 144 SMD2835 24V 4000K IP20 6,5W 200lm/W	138
243714	Taśma LED 300 SMD2835 12V MULTIBIAŁY IP20 9,6W	138
241819	Taśma LED 300 SMD2835 24V MULTIBIAŁY IP20 9,6W	138
479938	Taśma LED 60 SMD 24V 4000K 14W CRI98	139
248238	Taśma LED 300 SMD 12V RGB 14,4W DIGITAL P943	139
249167	Taśma LED 600 SMD 12V 4000K 9,6W 5mm WPCB	139
246463	Taśma LED 300 SMD 12V 2400K 4,8W	141
240164	Taśma LED 300 SMD 12V 3000K 4,8W	141
249419	Taśma LED 300 SMD 12V 3000K 4,8W 30m	141
477200	Taśma LED 300 SMD 12V 3000K 4,8W 50m	141
245602	Taśma LED 300 SMD 12V 4000K 4,8W	141
249426	Taśma LED 300 SMD 12V 4000K 4,8W 30m	141
477194	Taśma LED 300 SMD 12V 4000K 4,8W 50m	141
240188	Taśma LED 300 SMD 12V 6500K 4,8W	141
249433	Taśma LED 300 SMD 12V 6500K 4,8W 30m	141
477217	Taśma LED 300 SMD 12V 6500K 4,8W 50m	141
240195	Taśma LED 300 SMD 12V 11000K 4,8W	141
249440	Taśma LED 300 SMD 12V 11000K 4,8W 30m	141
240645	Taśma LED 300 SMD 24V 3000K 4,8W	142
241758	Taśma LED 300 SMD 24V 3000K 4,8W 30m	142
240652	Taśma LED 300 SMD 24V 4000K 4,8W	142
241765	Taśma LED 300 SMD 24V 4000K 4,8W 30m	142
240676	Taśma LED 300 SMD 24V 6500K 4,8W	142
241789	Taśma LED 300 SMD 24V 6500K 4,8W 30m	142
240690	Taśma LED 300 SMD 24V 11000K 4,8W	142
241796	Taśma LED 300 SMD 24V 11000K 4,8W 30m	142
240201	Taśma LED 300 SMD 12V czerwona 4,8W	142
240225	Taśma LED 300 SMD 12V zielona 4,8W	142
240218	Taśma LED 300 SMD 12V niebieska 4,8W	142
240232	Taśma LED 300 SMD 12V żółta 4,8W	142
477132	Taśma LED 600 SMD 12V 2700K 9,6W	143
477262	Taśma LED 600 SMD 12V 2700K 9,6W 30m	143
477149	Taśma LED 600 SMD 12V 4000K 9,6W	143
477279	Taśma LED 600 SMD 12V 4000K 9,6W 30m	143
477156	Taśma LED 600 SMD 12V 6500K 9,6W	143
477118	Taśma LED 600 SMD 12V 4000K 9,6W	143
240140	Taśma LED 150 SMD 12V RGB 7,2W	143
240522	Taśma LED 300 SMD 12V RGB 14,4W	143
477255	Taśma LED 300 SMD 12V RGB 14,4W 30m	143
240539	Taśma LED 300 SMD 24V RGB 14,4W	143
477675	Taśma LED 300 SMD 24V RGB 14,4W 30m	143
247071	Taśma LED 300 SMD 12V 2700K RGBW 19,2W	144
477231	Taśma LED 300 SMD 12V 2700K RGBW 19,2W 30m	144
477309	Taśma LED 300 SMD 12V 4000K RGBW 19,2W	144
245657	Taśma LED 300 SMD 12V 6500K RGBW 19,2W	144

Symbol	Nazwa produktu	Strona
477248	Taśma LED 300 SMD 12V 6500K RGBW 19,2W 30m	144
241673	Taśma LED 300 SMD 24V 2700K RGBW 19,2W	144
477316	Taśma LED 300 SMD 24V 4000K RGBW 19,2W	144
241680	Taśma LED 300 SMD 24V 6500K RGBW 19,2W	144
240249	Taśma LED 300 SMD 12V 3000K 4,8W IP65	146
245619	Taśma LED 300 SMD 12V 4000K 4,8W IP65	146
240256	Taśma LED 300 SMD 12V 6500K 4,8W IP65	146
240263	Taśma LED 300 SMD 12V 11000K 4,8W IP65	146
240713	Taśma LED 300 SMD 24V 3000K 4,8W IP65	146
240720	Taśma LED 300 SMD 24V 4000K 4,8W IP65	146
240744	Taśma LED 300 SMD 24V 6500K 4,8W IP65	146
241147	Taśma LED 300 SMD 24V 11000K 4,8W IP65	146
241468	Taśma LED 300 SMD 12V 3000K 4,8W IP67	147
245626	Taśma LED 300 SMD 12V 4000K 4,8W IP67	147
240270	Taśma LED 300 SMD 12V czerwona 4,8W IP65	147
240294	Taśma LED 300 SMD 12V zielona 4,8W IP65	147
240287	Taśma LED 300 SMD 12V niebieska 4,8W IP65	147
471345	Taśma LED 600 SMD 12V 2700K 9,6W IP65	148
477040	Taśma LED 600 SMD 12V 4000K 9,6W IP65	148
477057	Taśma LED 600 SMD 12V 6500K 9,6W IP65	148
240157	Taśma LED 150 SMD 12V RGB 7,2W IP65	148
240614	Taśma LED 300 SMD 12V RGB 14,4W IP65	148
241741	Taśma LED 300 SMD 24V RGB 14,4W IP65	148
241451	Taśma LED 300 SMD 12V RGB 14,4W IP67	149
478351	Złączka taśm COB CLICK CONNECTOR pojedyncza z przewodem 10 mm 2 PIN	151
478368	Złączka taśm COB CLICK CONNECTOR podwójna 10 mm 2 PIN z kablem	151
202481	Złączka taśm COB CLICK CONNECTOR pojedyncza z przewodem 8 mm 2 PIN	151
200456	Złączka taśm COB LED łącznik kątowy 2700K 8mm 2 PIN typ L 8W	152
200463	Złączka taśm COB LED łącznik kątowy 4000K 8mm 2 PIN typ L 8W	152
200470	Złączka taśm COB LED łącznik kątowy 6500K 8mm 2 PIN typ L 8W	152
200487	Złączka taśm COB LED łącznik kątowy 2700K 8mm 2 PIN typ L 11W	152
200494	Złączka taśm COB LED łącznik kątowy 4000K 8mm 2 PIN typ L 11W	152
200500	Złączka taśm COB LED łącznik kątowy 6500K 8mm 2 PIN typ L 11W	152
200517	Złączka taśm COB LED łącznik kątowy 2700K 10mm 2 PIN typ L 14W	152
200524	Złączka taśm COB LED łącznik kątowy 4000K 10mm 2 PIN typ L 14W	152
200531	Złączka taśm COB LED łącznik kątowy 6500K 10mm 2 PIN typ L 14W	152
478412	Złączka taśm COB CLICK łącznik kątowy 2700K 10 mm 2 PIN typ L 18W	152
478429	Złączka taśm COB CLICK łącznik kątowy 4000K 10 mm 2 PIN typ L 18W	152
478436	Złączka taśm COB CLICK łącznik kątowy 6000K 10 mm 2 PIN typ L 18W	152
200548	Złączka taśm COB CLICK CONNECTOR podwójna 8mm 2 PIN typ L	153
200555	Złączka taśm COB CLICK CONNECTOR podwójna 10mm 2 PIN typ L	153
200609	Złączka taśm COB CLICK CONNECTOR podwójna 8mm 2 PIN	153
200616	Złączka taśm COB CLICK CONNECTOR podwójna 10mm 2 PIN	153
200623	COB RGB Złączka taśm CLICK CONNECTOR podwójna 10mm 4 PIN	153

Symbol	Nazwa produktu	Strona	Symbol	Nazwa produktu	Strona
246555	Taśma COB CLICK łącznik kątowy 8 mm 2 PIN typ T	154	202832	Downlight EASY FIX PRO 12W 1080lm CCT okrągły	178
246524	Taśma COB CLICK łącznik kątowy 10 mm 4 PIN typ T RGB	154	202849	Downlight EASY FIX PRO 18W 1800lm CCT okrągły	178
246562	Taśma COB CLICK łącznik kątowy 8 mm 2 PIN typ L	154	202856	Downlight EASY FIX PRO 24W 2400lm CCT okrągły	179
246517	Taśma COB CLICK łącznik kątowy 10 mm 4 PIN typ L RGB	154	202863	Downlight EASY FIX PRO 18W 1800lm CCT kwadratowy	179
246548	Taśma COB CLICK łącznik kątowy 8 mm 2 PIN typ +	154	202870	Downlight EASY FIX PRO 24W 2400lm CCT kwadratowy	179
246531	Taśma COB CLICK łącznik kątowy 10 mm 4 PIN typ + RGB	154	248771	Downlight EASY FIX 6W 450lm 2700K okrągły	181
247859	Taśma COB CLICK łącznik kątowy 12 mm 5 PIN typ + RGBW	154	248788	Downlight EASY FIX 6W 470lm 4000K okrągły	181
200586	Zacisk montażowy taśmy 8mm	155	248818	Downlight EASY FIX 18W 1570lm 2700K okrągły	181
200593	Zacisk montażowy taśmy 10mm	155	248825	Downlight EASY FIX 18W 1650lm 4000K okrągły	181
200562	Uchwyt montażowy taśmy 8mm	155	248849	Downlight EASY FIX 24W 2300lm 4000K okrągły	181
200579	Uchwyt montażowy taśmy 10mm	155	248832	Downlight EASY FIX 24W 2200lm 2700K okrągły	181
244193	Panel DIORA 15-36W 2250-5040lm 4000K	159	246784	Downlight EASY FIX 6W 470lm 4000K kwadratowy	182
471260	Panel DIORA 36W 5040lm 4000K 1-10V	159	246777	Downlight EASY FIX 6W 450lm 2700K kwadratowy	182
475459	Panel 2in1 30W 3600lm 4000K 120x30 1195x295	163	246890	Downlight EASY FIX 12W 890lm 4000K kwadratowy	182
478481	Panel 2in1 30W 3600lm 4000K 595x595	163	246791	Downlight EASY FIX 12W 850lm 2700K kwadratowy	182
202474	Panel Slim 40W 4400lm 4000K UGR<19 595x595	165	249464	Downlight EASY FIX 18W 1450lm 4000K kwadratowy	182
205970	Panel Backlit 25W 4000lm 4000K 595x595	167	249457	Downlight EASY FIX 18W 1300lm 2700K kwadratowy	182
205987	Panel Backlit 25W 4000lm 4000K 595x595 0-10V	167	249488	Downlight EASY FIX 24W 2300lm 4000K kwadratowy	183
201255	Panel Backlit 28W 4000lm 4000K 595x595	167	249471	Downlight EASY FIX 24W 2150lm 2700K kwadratowy	183
205819	Panel Backlit 34W 4760lm 4000K 595x595	167	200739	Downlight MOLLY 5W 450lm 3000K okrągły	185
205826	Panel Backlit 34W 4760lm 4000K 595x595 0-10V	167	200746	Downlight MOLLY 5W 500lm 4000K okrągły	185
200180	Panel Backlit 40W 4800lm 4000K 595x595	167	200753	Downlight MOLLY 9W 830lm 3000K okrągły	185
201248	Panel Backlit 40W 4800lm 4000K 595x595 0-10V	167	200760	Downlight MOLLY 9W 900lm 4000K okrągły	185
205833	Panel Backlit 34W 4760lm 4000K UGR<19 595x595	167	200777	Downlight MOLLY 12W 1150lm 3000K okrągły	185
205864	Panel Backlit 34W 4760lm 4000K UGR<19 595x595 0-10V	167	200784	Downlight MOLLY 12W 1250lm 4000K okrągły	185
203457	Panel Backlit 42W 6300lm 4000K UGR<19 595x595	167	200791	Downlight MOLLY 18W 1750lm 3000K okrągły	186
201330	Panel Backlit 40W 4800lm 4000K 1195x295	168	200807	Downlight MOLLY 18W 1900lm 4000K okrągły	186
206519	Panel Backlit 34W 4760lm 4000K UGR<19 1195x295	168	200999	Downlight MOLLY 18W 1900lm CCT 3000-4000-6000K okrągły	186
206526	Panel Backlit 34W 4760lm 4000K UGR<19 1195x295 0-10V	168	201019	Downlight MOLLY 18W 1900lm 4000K okrągły z czujnikiem ruchu	186
204522	Panel Backlit 34W 4760lm 4000K UGR<19 620x620	168	200814	Downlight MOLLY 24W 2350lm 3000K okrągły	186
204539	Panel Backlit 34W CCT 4760lm UGR<19 620x620	168	200821	Downlight MOLLY 24W 2550lm 4000K okrągły	186
202887	Panel Backlit 40W 4000K 4000lm 595x595	169	201002	Downlight MOLLY 24W 2550lm CCT 3000-4000-6000K okrągły	186
203440	Ramka montażowa wys. 65mm 60x60	171	201026	Downlight MOLLY 24W 2550lm 4000K okrągły z czujnikiem ruchu	186
201347	Sprężynowe uchwyty do paneli Backlit	171	201033	Downlight MOLLY 5W 450lm 3000K kwadratowy	187
245725	Sprężyny do SLIM Panel, 2in1 Panels, Frame Panel i DIORA	171	201040	Downlight MOLLY 5W 500lm 4000K kwadratowy	187
245718	Haczyki do paneli	171	200838	Downlight MOLLY 9W 830lm 3000K kwadratowy	187
245701	Stalowe linki	171	200845	Downlight MOLLY 9W 900lm 4000K kwadratowy	187
477392	Downlight QUANTUM 7W 700lm 4000K	173	200852	Downlight MOLLY 12W 1150lm 3000K kwadratowy	187
477477	Downlight QUANTUM 7W 700lm 4000K 1-10V	173	200869	Downlight MOLLY 12W 1250lm 4000K kwadratowy	187
477408	Downlight QUANTUM 15W 1500lm 4000K	173	200876	Downlight MOLLY 18W 1750lm 3000K kwadratowy	188
477484	Downlight QUANTUM 15W 1500lm 4000K 1-10V	173			
202122	Downlight CALMOS 18W 2100lm 4000K IP44	175			
202139	Downlight CALMOS 24W 2800lm 4000K IP44	175			
202825	Downlight EASY FIX PRO 6W 540lm CCT okrągły	178			

Symbol	Nazwa produktu	Strona
200883	Downlight MOLLY 18W 1900lm 4000K kwadratowy	188
200890	Downlight MOLLY 24W 2550lm 3000K kwadratowy	188
200906	Downlight MOLLY 24W 2550lm 4000K kwadratowy	188
200913	Ramka do montażu natynkowego Downlight MOLLY 9W okrągła	189
200920	Ramka do montażu natynkowego Downlight MOLLY 12W okrągła	189
200937	Ramka do montażu natynkowego Downlight MOLLY 18W okrągła	189
200944	Ramka do montażu natynkowego Downlight MOLLY 24W okrągła	189
200951	Ramka do montażu natynkowego Downlight MOLLY 9W kwadratowa	189
200968	Ramka do montażu natynkowego Downlight MOLLY 12W kwadratowa	189
200975	Ramka do montażu natynkowego Downlight MOLLY 18W kwadratowa	189
200982	Ramka do montażu natynkowego Downlight MOLLY 24W kwadratowa	189
470614	Downlight FRAMELESS panel 8W 800lm 2700K	191
470621	Downlight FRAMELESS panel 8W 800lm 4000K	191
470638	Downlight FRAMELESS 18W 1800lm 2700K	191
470645	Downlight FRAMELESS 18W 1800lm 4000K	191
478252	Oprawa do szynoprzewodu jednofazowego GU10 czarna PIPE	193
475442	Oprawa do szynoprzewodu jednofazowego GU10 biała PIPE	193
478276	Oprawa natynkowa GU10 czarna PIPE	193
478283	Oprawa natynkowa GU10 biała PIPE	193
478290	Oprawa zwieszana GU10 czarna PIPE	193
478306	Oprawa zwieszana GU10 biała PIPE	193
201606	Źródło światła LED E14 5W 700lm 2700K 170-250V C37 ŚWIECZKA	195
201613	Źródło światła LED E14 5W 700lm 4000K 170-250V C37 ŚWIECZKA	195
201620	Źródło światła LED E14 5W 700lm 6500K 170-250V C37 ŚWIECZKA	195
247576-II	Źródło światła LED E14 7W 1000lm 2700K 170-250V C37 ŚWIECZKA	195
247583-II	Źródło światła LED E14 7W 1000lm 4000K 170-250V C37 ŚWIECZKA	195
201651	Źródło światła LED E14 7W 1000lm 6500K 170-250V C37 ŚWIECZKA	195
248610-II	Źródło światła LED E14 9W 1260lm 2700K 170-250V C37 ŚWIECZKA	196
248627-II	Źródło światła LED E14 9W 1260lm 4000K 170-250V C37 ŚWIECZKA	196
201682	Źródło światła LED E14 9W 1260lm 6500K 170-250V C37 ŚWIECZKA	196
470232-II	Źródło światła LED E14 9W 1170lm 2700K 170-250V C37 DIM	196
470249-II	Źródło światła LED E14 9W 1170lm 4000K 170-250V C37 DIM	196
201729	Źródło światła LED E14 7W 1000lm 2700K 170-250V G45 KULKA	196
201736	Źródło światła LED E14 7W 1000lm 4000K 170-250V G45 KULKA	196
201743	Źródło światła LED E14 7W 1000lm 6500K 170-250V G45 KULKA	196
247590-II	Źródło światła LED E27 7W 1000lm 2700K 170-250V G45 KULKA	197
247606-II	Źródło światła LED E27 7W 1000lm 4000K 170-250V G45 KULKA	197
201774	Źródło światła LED E27 7W 1000lm 6500K 170-250V G45 KULKA	197

Symbol	Nazwa produktu	Strona
201781	Źródło światła LED E27 6W 840lm 2700K 170-250V A60	197
201798	Źródło światła LED E27 6W 840lm 4000K 170-250V A60	197
201804	Źródło światła LED E27 6W 840lm 6500K 170-250V A60	197
241710-II	Źródło światła LED E27 10W 1400lm 2700K 170-250V A60	198
241727-II	Źródło światła LED E27 10W 1400lm 4000K 170-250V A60	198
201835	Źródło światła LED E27 10W 1400lm 6500K 170-250V A60	198
241734-II	Źródło światła LED E27 13W 1820lm 2700K 170-250V A60	198
241772-II	Źródło światła LED E27 13W 1820lm 4000K 170-250V A60	198
201453	Źródło światła LED GU10 5W 700lm 2700K 170-250V	198
201460	Źródło światła LED GU10 5W 700lm 4000K 170-250V	198
201477	Źródło światła LED GU10 5W 700lm 6500K 170-250V	198
247613-II	Źródło światła LED GU10 7W 1000lm 2700K 170-250V	199
247620-II	Źródło światła LED GU10 7W 1000lm 4000K 170-250V	199
240737-II	Źródło światła LED GU10 7W 1000lm 6500K 170-250V	199
248580-II	Źródło światła LED GU10 10W 2700K 1400lm 170-250V	199
248597-II	Źródło światła LED GU10 10W 4000K 1400lm 170-250V	199
248603-II	Źródło światła LED GU10 10W 6500K 1400lm 170-250V	199
470218-II	Źródło światła LED GU10 10W 2700K 1250lm 170-250V DIM	199
470225-II	Źródło światła LED GU10 10W 4000K 1250lm 170-250V DIM	199
248108-II	Źródło światła LED CERAMIC GU11 3W 330lm 170-250V 110lm/W	200
248122-II	Źródło światła LED CERAMIC GU11 3W 330lm 4000K	200
248115-II	Źródło światła LED LED CERAMIC GU11 3W 330lm 6500K	200
248139-II	Źródło światła LED CERAMIC MR11 3W 2700K 330lm 10-14V	200
248146-II	Źródło światła LED CERAMIC MR11 3W 4000K 330lm 10-14V	200
248153-II	Źródło światła LED CERAMIC MR11 3W 6500K 330lm 10-14V	200
201903	LED light CERAMIC MR16 5W 600lm 2700K 10-18V	201
201910	LED light CERAMIC MR16 5W 600lm 4000K 10-18V	201
201927	LED light CERAMIC MR16 5W 600lm 6500K 10-18V	201
201934	Źródło światła LED CERAMIC MR16 8,5W 1020lm 2700K 10-18V	201
201941	Źródło światła LED CERAMIC MR16 8,5W 1020lm 4000K 10-18V	201
201958	Źródło światła LED CERAMIC MR16 8,5W 1020lm 6500K 10-18V	201
247286	Źródło światła LED SMD 5W 400lm 2700K 220-260V 50mm	202
470720	Źródło światła LED SMD 5W 400lm 2700K 220-260V 50mm DIM	202
247293	Źródło światła LED SMD 5W 400lm 4000K 220-260V 50mm	202
470737	Źródło światła LED SMD 5W 400lm 4000K 220-260V 50mm DIM	202

Symbol	Nazwa produktu	Strona	Symbol	Nazwa produktu	Strona
470560	Źródło światła LED SMD 5W 400lm 6500K 220-260V 50mm	202	202412	Źródło światła LED FILAMENT E27 4W 210lm 1800K 220-240V ST64 RETRO VINTAGE GRAFIT ŚCIEMNALNE	210
470744	Źródło światła LED SMD 5W 400lm 6500K 220-260V 50mm DIM	202	202399	Źródło światła LED FILAMENT E27 4W 210lm 1800K 220-240V ST64 RETRO VINTAGE ŚCIEMNALNE	210
245480	Źródło światła LED G9 4W 350lm 2700K 220-240V	202	202375	Źródło światła LED FILAMENT E27 4W 210lm 1800K 220-240V G125 RETRO VINTAGE GOLD ŚCIEMNALNE	211
245534	Źródło światła LED G9 4W 350lm 4000K 220-240V	202	202382	Źródło światła LED FILAMENT E27 4W 210lm 1800K 220-240V G125 RETRO VINTAGE GRAFIT ŚCIEMNALNE	211
245541	Źródło światła LED G9 4W 350lm 6000K 220-240V	202	202368	Źródło światła LED FILAMENT E27 4W 210lm 1800K 220-240V G125 RETRO VINTAGE ŚCIEMNALNE	211
245947	Źródło światła LED G9 6W 550lm 2700K 220-240V	203	202184	Źródło światła LED FILAMENT E14 4W 480lm 2700K 220-240V C35 ŚWIECZKA	211
245954	Źródło światła LED G9 6W 550lm 4000K 220-240V	203	202191	Źródło światła LED FILAMENT E14 4W 480lm 4000K 220-240V C35 ŚWIECZKA	211
245961	Źródło światła LED G9 6W 550lm 6000K 220-240V	203	202306	Źródło światła LED FILAMENT E14 5W 600lm 2700K 220-240V C35 ŚWIECZKA ŚCIEMNALNE	211
247903	Źródło światła LED G9 8W 750lm 2700K 220-240V	203	202313	Źródło światła LED FILAMENT E14 5W 600lm 4000K 220-240V C35 ŚWIECZKA ŚCIEMNALNE	211
247910	Źródło światła LED G9 8W 750lm 4000K 220-240V	203	202207	Źródło światła LED FILAMENT E14 6W 720lm 2700K 220-240V C35 ŚWIECZKA	212
247927	Źródło światła LED G9 8W 750lm 6000K 220-240V	203	202214	Źródło światła LED FILAMENT E14 6W 720lm 4000K 220-240V C35 ŚWIECZKA	212
248900	Źródło światła LED G9 12W 1160lm 2700K 220-240V	203	202221	Źródło światła LED FILAMENT E14 4W 480lm 2700K 220-240V G45 KULKA	212
248917	Źródło światła LED G9 12W 1160lm 4000K 220-240V	203	202238	Źródło światła LED FILAMENT E14 4W 480lm 4000K 220-240V G45 KULKA	212
248924	Źródło światła LED G9 12W 1160lm 6000K 220-240V	203	202269	Źródło światła LED FILAMENT E27 7W 840lm 2700K 220-240V A60 KULKA	212
242250	Źródło światła LED GU10 1W 80lm 2700K 220-260V	205	202276	Źródło światła LED FILAMENT E27 7W 840lm 4000K 220-240V A60 KULKA	212
248337	Źródło światła LED GU10 1W 80lm 4000K 220-260V	205	202320	Źródło światła LED FILAMENT E27 7W 840lm 2700K 220-240V A60 KULKA ŚCIEMNALNA	213
242267	Źródło światła LED GU10 1W 80lm 6500K 220-260V	205	202337	Źródło światła LED FILAMENT E27 7W 840lm 4000K 220-240V A60 KULKA ŚCIEMNALNA	213
242298	Źródło światła LED GU10 1W 20lm 220-260V zielone	205	202283	Źródło światła LED FILAMENT E27 10W 1200lm 2700K 220-240V A60 KULKA	213
242281	Źródło światła LED GU10 1W 20lm 220-260V niebieskie	205	202290	Źródło światła LED FILAMENT E27 10W 1200lm 4000K 220-240V A60 KULKA	213
247835	Źródło światła LED GU10 3W 273lm 2700K 220-260V 36°	206	247255	Źródło światła LED E27 6W 510lm 3000K 220-260V A60	215
247828	Źródło światła LED GU10 3W 273lm 4000K 220-260V 36°	206	247262	Źródło światła LED E27 6W 510lm 4000K 220-260V A60	215
247811	Źródło światła LED GU10 3W 273lm 6500K 220-260V 36°	206	247385	Źródło światła LED E27 10W 940lm 3000K 220-260V A60	215
241963	Źródło światła LED GU10 5W 450lm 2700K 220-260V 120°	206	247392	Źródło światła LED E27 10W 940lm 4000K 220-260V A60	215
241970	Źródło światła LED GU10 5W 450lm 4000K 220-260V 120°	206	247422	Źródło światła LED E27 15W 1515lm 3000K 220-260V A60	215
241987	Źródło światła LED GU10 5W 450lm 6500K 220-260V 120°	206	247439	Źródło światła LED E27 15W 1515lm 4000K 220-260V A60	215
240621	Źródło światła LED M16 5,5W 500lm 2700K 220-240V DIM	207	470317	Źródło światła LED E27 1W 80lm 3000K 220-260V G45	216
240638	Źródło światła LED M16 5,5W 550lm 4000K 220-240V DIM	207	247347	Źródło światła LED E14 6W 4000K 522lm 220-240V C37	216
248948	Źródło światła LED GU10 5,5W 345lm 2200-3000K 220-240V	207	247354	Źródło światła LED E14 6W 3000K 522lm 220-240V C37	216
247804	Źródło światła LED MR11 3W 273lm 2700K 10-14V AC/DC 36°	208	471215	Źródło światła LED E14 8W 720lm 3000K 220-260V C37	216
247798	Źródło światła LED MR11 3W 273lm 4000K 10-14V AC/DC 36°	208	471222	Źródło światła LED E14 8W 720lm 4000K 220-260V C37	216
247781	Źródło światła LED MR11 3W 273lm 6500K 10-14V AC/DC 36°	208	248658	Źródło światła LED GU10 3W 240lm 3000K 220-260V	217
202344	Źródło światła LED FILAMENT E27 4W 840lm 4000K 220-240V A60 KULKA	210	248665	Źródło światła LED GU10 3W 240lm 4000K 220-260V	217
202351	Źródło światła LED FILAMENT E27 7W 1470lm 4000K 220-240V A60 KULKA	210	244001	Źródło światła LED GU10 3W 240lm 6500K 220-260V	217
202405	Źródło światła LED FILAMENT E27 4W 210lm 1800K 220-240V ST64 RETRO VINTAGE GOLD ŚCIEMNALNE	210			

Symbol	Nazwa produktu	Strona
248689	Źródło światła LED GU10 5W 450lm 3000K 220-260V	217
244346	Źródło światła LED GU10 5W 450lm 4000K 220-260V	217
244728	Źródło światła LED GU10 7W 600lm 3000K 220-260V	217
244766	Źródło światła LED GU10 7W 600lm 6500K 220-260V	217
248979	Źródło światła LED G4 COB 1,5W 120lm 2700K 12V AC/DC	218
248986	Źródło światła LED G4 COB 1,5W 120lm 6000K 12V AC/DC	218
244506	Źródło światła LED G4 2W 220lm 3000K 12V DC SMD3014 SL	218
244520	Źródło światła LED G4 2W 220lm 6000K 12V DC SMD3014 SL	218
470324	Źródło światła LED ES111 12W 1080lm 2700K 230V AC 45°	219
470331	Źródło światła LED ES111 12W 1080lm 4000K 230V AC 45°	219
249587	Źródło światła LED ES111 9W 850lm 4000K 175-265V białe	219
249624	Źródło światła LED ES111 9W 850lm 4000K 175-265V czarne	219
202061	LED Tube T8 9W 1350lm 4000K 220-240V 60cm	221
202078	LED Tube T8 9W 1350lm 6500K 220-240V 60cm	221
202085	LED Tube T8 18W 2700lm 4000K 220-240V 120cm	221
202092	LED Tube T8 18W 2700lm 6500K 220-240V 120cm	221
202108	LED Tube T8 22W 3300lm 4000K 220-240V 150cm	221
202115	LED Tube T8 22W 3300lm 6500K 220-240V 150cm	221
202009	LED Tube T8 9W 900lm 4000K 220-240V 60cm	221
202016	LED tube T8 9W 900lm 6500K 220-240V 60cm	221
202023	LED Tube T8 18W 1820lm 4000K 220-240V 120cm	221
202030	LED Tube T8 18W 1820lm 6500K 220-240V 120cm	221
202047	LED Tube T8 22W 2265lm 4000K 220-240V 150cm	221
202054	LED Tube T8 22W 2265lm 6500K 220-240V 150cm	221
242052	Źródło światła LED adapter E14->E27	223
242069	Źródło światła LED adapter E14->GU10	223
246173	Źródło światła LED adapter E14->MR16	223
246166	Źródło światła LED adapter E14->G9	223
242076	Źródło światła LED adapter E27->E14	223
242090	Źródło światła LED adapter E27->GU10	223
246210	Źródło światła LED adapter E27->MR16	223
246241	Źródło światła LED adapter E27->E40	223
242083	Źródło światła LED adapter E27->2xE27	223
242021	Przedłużka mocowania żarówki LED E27->E27 200mm	224
242038	Przedłużka mocowania żarówki LED E27->E14 200mm	224
242045	Przedłużka mocowania żarówki LED E27->GU10 200mm	224
242113	Źródło światła LED adapter GU10->E27	224
242106	Źródło światła LED adapter GU10->E14	224
246180	Źródło światła LED adapter GU10->MR16	224
246197	Źródło światła LED adapter MR16->GU10	224
246289	Źródło światła LED adapter E40->E27	225
246302	Źródło światła LED adapter B22->E14	225
246258	Źródło światła LED adapter B22->E27	225

Symbol	Nazwa produktu	Strona
246272	Źródło światła LED adapter B22->GU10	225
246319	Źródło światła LED adapter B22->E40	225
246449	Ceramiczna oprawka GU10 z przewodem 13cm	225
246685	Ceramiczna oprawka GU5,3 z przewodem 16cm	225
203846	Lampa stołowa TAZA 3,5W 400lm 3000K - 5000K biała	227
203853	Lampa stołowa TAZA 3,5W 400lm 3000K - 5000K czarna	227
204430	Lampa stołowa TAZA 3,5W 400lm 3000K - 5000K zielona	227
204447	Lampa stołowa TAZA 3,5W 400lm 3000K - 5000K pastelowa różowa	227
208971	Lampa stołowa TAZA 3,5W 400lm 3000K - 5000K złota	227
208694	Lampa stołowa TAZA 3,5W 400lm 3000K - 5000K żółta	227
204423	Lampa stołowa CAMELIA 2,5W 250lm 3000K - 5000K czarna	229
204454	Lampa stołowa CAMELIA 2,5W 250lm 3000K - 5000K srebrna	229
204461	Lampa stołowa CAMELIA 2,5W 250lm 3000K - 5000K złota	229
204492	Lampa stołowa RIWIA 1,0W 120lm 3000K - 5000K złota	231
204478	Lampa stołowa RIWIA 1,0W 120lm 3000K - 5000K srebrna	231
204485	Lampa stołowa RIWIA 1,0W 120lm 3000K - 5000K różowo złota	231
249877	JUTE Oprawa zwieszana sznur 1.5 metra 1xE27	233
249884	JUTE Oprawa zwieszana sznur 1.5 metra 2xE27	233
249891	JUTE Oprawa zwieszana sznur 1.5 metra 3xE27	233
241321	Oprawa sufitowa okrągła czarno-złota	235
241314	Oprawa sufitowa okrągła bialo-złota	235
244810	Oprawa sufitowa okrągła ruchoma czarna szczotkowana	236
244896	Oprawa sufitowa okrągła ruchoma srebro szczotkowana	236
244902	Oprawa sufitowa okrągła ruchoma srebro gres	236
241284	Oprawa sufitowa okrągła ruchoma SLIM biała szczotkowana OROSA	236
241253	Oprawa sufitowa okrągła ruchoma SLIM czarna szczotkowana OROSA	236
241239	Oprawa sufitowa okrągła ruchoma SLIM srebro szczotkowane OROSA	236
241208	Oprawa sufitowa kwadratowa ruchoma SLIM czarna szczotkowana AKROS	237
241215	Oprawa sufitowa kwadratowa ruchoma SLIM srebro szczotkowane AKROS	237
241222	Oprawa sufitowa kwadratowa ruchoma SLIM biała mat AKROS	237
249235	Oprawa sufitowa okrągła odlew czarna	237
242823	Oprawa sufitowa okrągła odlew satyna	237
242854	Oprawa sufitowa okrągła odlew biała	237
242885	Oprawa sufitowa okrągła ruchoma odlew satyna	238
242915	Oprawa sufitowa okrągła ruchoma odlew biała	238
249259	Oprawa sufitowa okrągła ruchoma odlew czarna	238
242939	Oprawa sufitowa kwadratowa ruchoma odlew złota	238
242946	Oprawa sufitowa kwadratowa ruchoma odlew satyna	238
242977	Oprawa sufitowa kwadratowa ruchoma odlew biała	238
241093	Oprawa aluminiowa kwadrat czarna szczotkowana ruchoma	238

Symbol	Nazwa produktu	Strona
240683	Oprawa aluminiowa kwadrat biała szczotkowana ruchoma	238
240669	Oprawa aluminiowa kwadrat srebrna szczotkowana ruchoma	238
249266	Oprawa sufitowa wodoodporna MR11 okrągła biała	240
249273	Oprawa sufitowa wodoodporna MR11 okrągła chrom	240
249297	Oprawa sufitowa wodoodporna MR11 okrągła czarna	240
245428	Oprawa sufitowa wodoodporna okrągła odlew biała	240
245435	Oprawa sufitowa wodoodporna okrągła odlew chrom	240
245442	Oprawa sufitowa wodoodporna okrągła odlew satyna	240
471055	Oprawa sufitowa wodoodporna okrągła odlew czarna	240
245374	Oprawa sufitowa wodoodporna kwadrat odlew biała	241
245398	Oprawa sufitowa wodoodporna kwadrat odlew satyna	241
471062	Oprawa sufitowa wodoodporna kwadrat odlew czarna	241
242540	Oprawa natynkowa wodoodporna okrągła biała TUBE	241
242557	Oprawa natynkowa wodoodporna okrągła czarna TUBE	241
242656	Oprawa wpuszczana okrągła ruchoma czarna ROLLO MIDI	243
243851	Oprawa wpuszczana okrągła biała ROLLO MIDI	243
243134	Oprawa wpuszczana okrągła srebro ROLLO MIDI	243
243141	Oprawa wpuszczana kwadrat biała CUBO MIDI	245
249723	Oprawa natynkowa punktowa kwadrat biała CUBO	245
249747	Oprawa natynkowa punktowa kwadrat srebro CUBO	245
243400	LED OPTO moduł 1x SMD2835 12V 6500K 1W IP65	247
243417	LED OPTO moduł 2x SMD2835 12V 6500K 2W IP65	247
243424	LED OPTO moduł 3x SMD2835 12V 6500K 2,5W IP65	247
243431	LED OPTO moduł 4x SMD2835 12V 6500K 3W IP65	248
471321	Pilot RF do kontrolera VARIANTE DIM/CCT	250
471338	Pilot RF do kontrolera VARIANTE RGB/RGBW	250
476937	MAG JOY Pilot do kontrolera VARIANTE	250
201200	Pilot ścienny RF do kontrolera VARIANTE DIM/CCT	251
201217	Pilot ścienny RF do kontrolera VARIANTE RGB	251
201224	Pilot ścienny RF do kontrolera VARIANTE RGBW/RGBCCT	251
203600	Pilot RF SLIM VARIANTE DIM/CCT/0-10V	252
477781	Kontroler VARIANTE LED RF WIFI TUYA 5in1	254
471277	Kontroler VARIANTE RF WIFI TUYA DIM	254
471284	Kontroler VARIANTE RF WIFI TUYA DIM / CCT	254
471291	Kontroler VARIANTE RF WIFI TUYA RGB	255
471307	Kontroler VARIANTE RF WIFI TUYA RGBW	255
471314	Kontroler VARIANTE RF RGB/RGBW + pilot	255
201231	Kontroler VARIANTE RF WIFI TUYA RGBCCT	256
201286	Kontroler VARIANTE RF SPI DIGITAL RGB	256
LL-12-12	Zasilacz 12W IP67 12V	258
LL-12-24	Zasilacz 12W IP67 12V	258
LL-20-12	Zasilacz 20W IP67 12V	258

Symbol	Nazwa produktu	Strona
LL-20-24	Zasilacz 20W IP67 24V	258
LL-35-12	Zasilacz 36W IP67 12V	258
LL-35-24	Zasilacz 36W IP67 24V	258
LL-50-12	Zasilacz 50W IP67 12V	259
LL-50-24	Zasilacz 50W IP67 24V	259
LL-60-12	Zasilacz 60W IP67 12V	259
LL-60-24	Zasilacz 60W IP67 24V	259
LL-75-12	Zasilacz 75W IP67 12V	259
LL-75-24	Zasilacz 75W IP67 24V	259
LL-100-12	Zasilacz 100W IP67 12V	260
LL-100-24	Zasilacz 100W IP67 24V	260
LL-150-12	Zasilacz 150W IP67 12V	260
LL-150-24	Zasilacz 150W IP67 24V	260
LL-200-12	Zasilacz 200W IP67 12V	260
LL-200-24	Zasilacz 200W IP67 24V	260
477965	LED Master Sensor Hi Motion On/Off	262
478009	LED Channel Sensor Hi Motion On/Off	262
477989	LED Master Sensor PIR	262
478023	LED Channel Sensor PIR	262
477958	LED Master Sensor Touch On/Off Dimmer	262
477996	LED Channel Sensor Touch On/Off Dimmer	262
477972	LED Master Sensor IR Door	262
478016	LED Channel Sensor IR Door	262
477736	LED Multipower 60-12 5A 60W 12V IP20	263
477743	Multipower 100-12 8,3A 100W 12V IP20	263
477934	Multipower LED Przewód do taśmy 2m	263
477927	Multipower Przewód przedłużający 2m	263
477941	LED Multipower Splitter 6 portów	263
203617	Profil aluminiowy nawierzchniowy 10mm anodowany 2000 mm z mlecznym kloszem	265
203624	Profil aluminiowy nawierzchniowy 10mm biały 2000 mm z mlecznym kloszem	265
203631	Profil aluminiowy nawierzchniowy 10mm czarny 2000 mm z mlecznym kloszem	265
203648	Profil aluminiowy narożny 10mm anodowany 2000 mm z mlecznym kloszem	265
203655	Profil aluminiowy narożny 10mm biały 2000 mm z mlecznym kloszem	265
203662	Profil aluminiowy narożny 10mm czarny 2000 mm z mlecznym kloszem	265
203679	Profil aluminiowy wpuszczany 10mm anodowany 2000 mm z mlecznym kloszem	265
203686	Profil aluminiowy wpuszczany 10mm biały 2000 mm z mlecznym kloszem	265
203693	Profil aluminiowy wpuszczany 10mm czarny 2000 mm z mlecznym kloszem	265

LEDIN Group Sp. z o.o.
Dębowa 1
07-410 Tobolice

kontakt@ledline.pl
ledline.pl

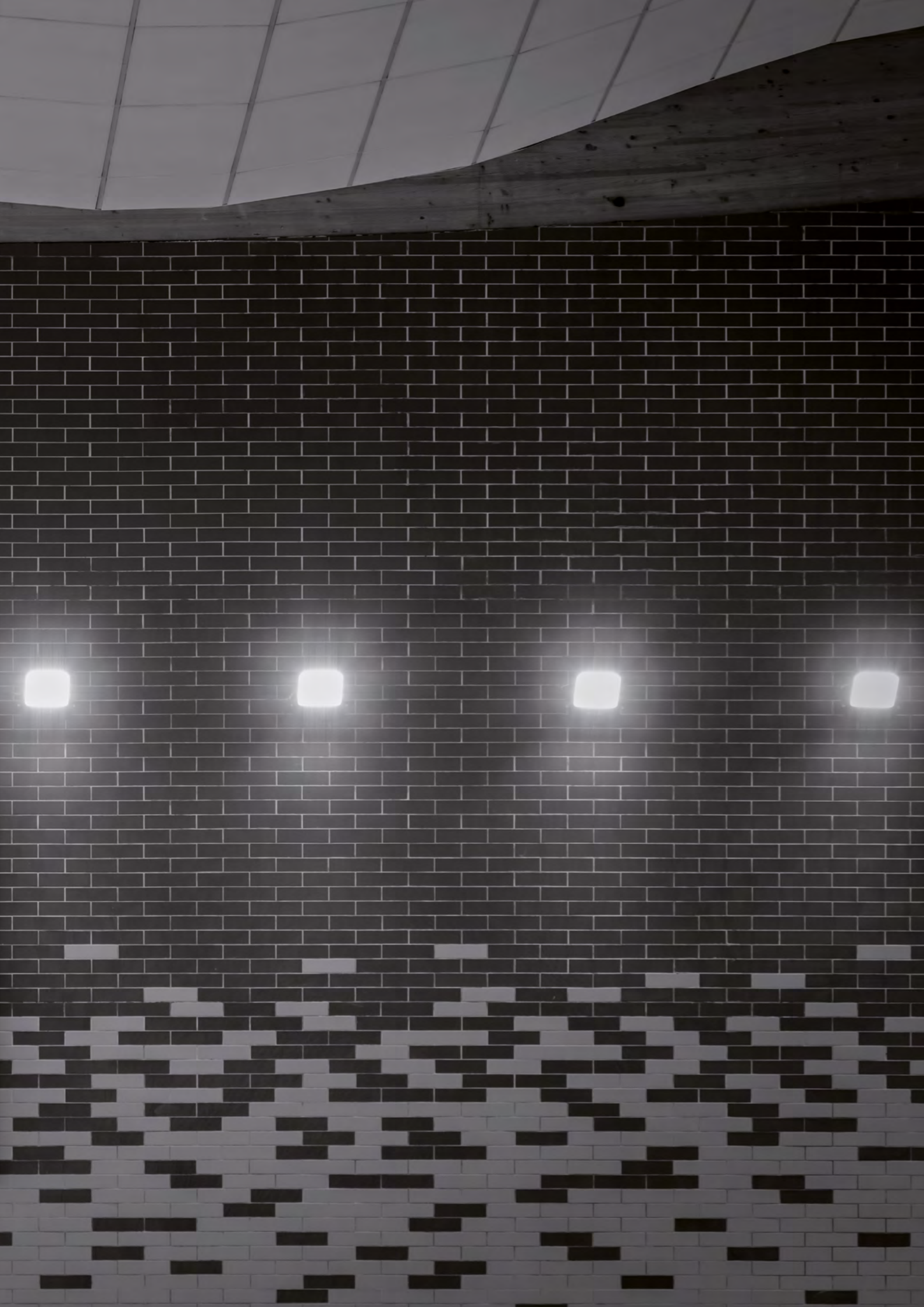

LED line